

平成30年度

健康ふくしま21調査報告書

平成31年2月

福 島 県

目 次

第1章 調査の概要

1 平成30年度健康ふくしま21調査実施要領	1
2 調査客体	3
(1) 調査世帯数	3
(2) 調査者数	3
(3) 回答者年齢階級別状況	3
3 集計及び作表方法	4
4 留意点	4
* 調査票様式	5

第2章 調査結果の概要	9
-------------	---

第3章 健康ふくしま21調査の結果

1 健康についての意識（満15歳以上対象）（調査票 問1）	36
2 健康づくりのために気をつけていること（満15歳以上対象）（調査票 問2）	40
3 「健康ふくしま21計画」の認知度（満15歳以上対象）（調査票 問3）	43
4 「県民健康の日」の認知度（満15歳以上対象）（調査票 問4）	47
5 食生活（朝食）の状況（満15歳以上対象）（調査票 問5）	50
6 食生活（朝食・夕食）の状況（満15歳以上対象）（調査票 問6）	53
7 「食育推進月間」「食育の日」の認知度（満15歳以上対象）（調査票 問7）	61
8 食生活（栄養バランス）の状況（満15歳以上対象）（調査票 問8）	65
9 「ロコモティブシンドローム」の認知度（満15歳以上対象）（調査票 問9）	68
10 最近1年間の運動状況（満15歳以上対象）（調査票 問10）	
(1) 運動の状況	71
(2) 運動時間（調査票 問10付問）	75
(3) 運動習慣の状況（満20歳以上対象）	79
11 喫煙の状況	
(1) 喫煙の有無（満20歳以上対象）（調査票 問11）	80
(2) 禁煙の意思（調査票 問11付問）	84
(3) 家族（世帯）の喫煙状況（調査票 問12）	88
13 受動喫煙の有無（満15歳以上対象）（調査票 問13）	89
14 「COPD（慢性閉塞性肺疾患）」の認知度（満15歳以上対象）（調査票 問14）	96
15 飲酒の状況（満20歳以上対象）（調査票 問15）	
(1) 飲酒の頻度	99
(2) 飲酒の量（調査票 問15付問）	103
(3) 飲酒の状況	106
16 定期的な歯科検診（満15歳以上対象）（調査票 問16）	108
17 歯みがきの状況（満15歳以上対象）（調査票 問17）	111
18 外出の状況（満15歳以上対象）（調査票 問18）	114
19 地域活動の実施状況（満15歳以上対象）（調査票 問19）	117
20 健診（検診）受診の状況（満15歳以上対象）（調査票 問20）	120
21 健診（検診）受診の機会（満15歳以上対象）（調査票 問21）	123

22	健診（検診）の際、重要視する点（満15歳以上対象）（調査票 問22）	125
23	睡眠時間の状況（満15歳以上対象）（調査票 問23）	131
24	疲労の状況（満15歳以上対象）（調査票 問24）	135
25	健康づくりのために必要と考えること（満15歳以上対象）（調査票 問25）	139
26	自由回答（満15歳以上対象）（調査票 問26）	140

第1章 調査の概要

1 平成30年度健康ふくしま21調査実施要領

1) 調査の目的

本調査は、第二次健康ふくしま21計画の中間評価を実施するに当たって、数値目標項目の現状の数値を把握する。また、併せて、第二次健康ふくしま21計画の普及状況、計画に関連する状況を把握する。

2) 調査規模（前回と同規模）

- 対象者 約10,000人（15歳以上） 住民基本台帳から世帯及び世帯員を抽出
約4,000世帯 世帯単位で調査を実施、県内の1世帯あたりの人数は、約2.6人（10,000人／2.56人＝約4,000世帯）

3) 主な調査方法

平成27年国勢調査を基に、県内7地域で無作為抽出した調査区で、全世帯15歳以上の県民（男女）に調査（層化無作為抽出方式）を実施し、郵送による自記式質問紙調査で行う。

4) 調査区選定方法

住民基本台帳（平成28年1月1日現在）における7方部別の15歳以上の人口割合及び方部毎の市（都市部）と町村（郡部）の人口比率を踏まえ、調査区を選定する。

全県1万人換算した人口（平成28年1月1日現在） (人)

方部	A 人口	方部人口割合	B 市人口	市割合 (B/A)	C 町村人口	町村割合(C/A)
県北	2,471	24.7%	2,238	90.6%	233	9.4%
県中	2,499	25.0%	2,256	90.3%	243	9.7%
県南	960	9.6%	318	33.2%	642	66.8%
会津	1,295	12.9%	883	68.2%	412	31.8%
南会津	148	1.5%	0	0.0%	148	100.0%
相双	928	9.3%	515	55.5%	413	44.5%
いわき	1,699	17.0%	1,699	100.0%	0	0.0%
計	10,000	100.0%	7,909	79.1%	2,091	20.9%

※人口は住民基本台帳（平成28年1月1日現在）における15歳以上の人口

<条件詳細>

- ① 調査対象者数は、15歳以上の県民（男女）約1万人とし、7方部別の人口割合に応じて各方部より抽出する。
- ② 調査対象者は世帯単位で抽出し、世帯は原則選定した調査区の全世帯を対象とする。
- ③ 調査区は平成27年国勢調査の調査区単位とし、各方部毎の市と町村の人口比率を考慮し選定する。
- ④ 平成27年国勢調査の調査区を基にした抽出ができない相双方部の町村は、調査地区を選定せず、町村毎の年代別人口の割合を考慮した上で、調査対象者を無作為に抽出する。なお、その場合に

において、当該町村内外の居住の有無は問わず、当該町村に住民票を有し、県内に居住している者を対象とする。

- ⑤ 上記の他、調査区の選定はすべて無作為とする。

【参考】 県内7方部の人口（平成28年1月1日現在） (人)

方部	A 人口	方部人口割合	B 市人口	市割合 (B/A)	C 町村人口	町村割合(C/A)
県北	423,419	24.7%	383,454	90.6%	39,965	9.4%
県中	428,374	25.0%	386,763	90.3%	41,611	9.7%
県南	164,515	9.6%	54,556	33.2%	109,959	66.8%
会津	221,900	12.9%	151,255	68.2%	70,645	31.8%
南会津	25,316	1.5%	0	0.0%	25,316	100.0%
相双	159,080	9.3%	88,286	55.5%	70,794	44.5%
いわき	291,127	17.0%	291,127	100.0%	0	0.0%
計	1,713,731	100.0%	1,355,441	79.1%	358,290	20.9%

※人口は住民基本台帳（平成28年1月1日現在）における15歳以上の人口

5) 調査内容

- (1) 質問項目 比較を可能とするため、健康ふくしま21計画の策定時（平成21年度）に調査した「県民健康調査表」の質問項目とし、その他、現状を踏まえ質問を追加する項目については、可能な限り、国や他県等の調査で用いている調査項目で比較検討可能なものとする。
- (2) 質問形式 該当番号を選択することを基本とするが、自由記述も数項目含む。

6) 調査実施時期

平成30年6月から平成30年11月まで（名簿作成、督促、集計等の実施時期も含む）

7) 集計について

エクセルによるデータ入力及び集計

8) 調査の実施形態

業者への委託により実施

9) 調査票等に関する秘密の保持

本調査は、健康や生活習慣等について、具体的な情報を取り扱うことから、対象者に係る情報を適切に取り扱い、その個人情報を保護するものとする。

特に、調査を委託して実施することから、受託者へ対し、個人情報の取り扱いに関しては適正な管理と厳重な秘密の保持を求めるものとする。

2 調査客体

県内約14,000の平成27年国勢調査区から選定した107調査区に在住する県民

(1) 調査世帯数

	対象世帯数	回答世帯数	回答率	備 考
県 北	1,132	557	49.2%	26調査区（福島市、二本松市、伊達市、桑折町、川俣町）
県 中	1,009	463	45.9%	24調査区（郡山市、須賀川市、田村市、鏡石町、天栄村、小野町）
県 南	401	195	48.6%	13調査区（白河市、西郷村、泉崎村、矢吹町、矢祭町、塙町、棚倉町）
会 津	656	330	50.3%	16調査区（会津若松市、喜多方市、西会津町、磐梯町、会津坂下町、金山町）
南会津	63	33	52.4%	3調査区（南会津町、下郷町）
相 双	375	134	35.7%	10調査区（相馬市、南相馬市、広野町、富岡町、大熊町、浪江町）
いわき	903	393	43.5%	15調査区（いわき市）
総 数	4,539	2,105	46.4%	(107調査区)

(2) 調査者数

	対象者数	回答者数	回答率	回答者男女別		備 考
				男	女	
県 北	2,659	1,143	43.0%	565	578	
県 中	2,332	918	39.4%	444	474	
県 南	952	371	39.0%	184	187	
会 津	1,354	588	43.4%	289	299	
南会津	160	73	45.6%	38	35	
相 双	917	252	27.5%	120	132	
いわき	1,787	721	40.3%	348	373	
総 数	10,161	4,066	40.0%	1,988	2,078	

(3) 回答者年齢階級別状況

年齢階級	総 数	男	女	備 考
15～19歳	144	76	68	
20～29歳	242	120	122	
30～39歳	379	206	173	
40～49歳	509	253	256	
50～59歳	603	272	331	
60～64歳	400	197	203	
65～69歳	500	245	255	
70～79歳	766	398	368	
80～89歳	452	203	249	
90歳～	71	18	53	
合 計	4,066	1,988	2,078	

3 集計及び作表方法

集計にあたっては、被調査世帯から記入後の調査票の返送を受けた後、計算ソフト「エクセル」を利用してデータを入力、集計し、作表を行った。

4 留意点

(1) 数 値

- %値：基数を100%とし、グラフや表では小数第2位を四捨五入して小数第1位までを表示している。
(注意) 四捨五入の関係で、個々を合計した%値と合わないことがある。
- 0.0：%値が0または、0.05に満たなかったもの。

(2) 集 計 表

集計表については、県全体の集計結果及び各地域別の集計結果を、調査票の設問順に掲載している（一部を除く）。

- 集計表においては、各年代ごとに、その人数及び割合（%）を記載

平成30年度健康ふくしま21調査

- この調査票は、満15歳以上(平成30年4月1日現在)男女を問わず記入してください。
- 性別と年齢を必ず記入願います。(氏名の記入は必要ありません。)
- 回答の仕方は、あてはまる番号に○をつけるものと、必要なことから書き込むものがあります。→印がある場合はそれに従ってください。
- 都合によりご自分で記入できない方は、代理の方に記入していただくようお願いいたします。

市町村名

地区番号

性別 1. 男 2. 女

年齢 歳

ご協力
よろしくお願ひします。

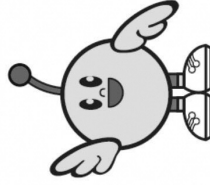

福 島 県

【健康づくりについて】

- 問1 あなたはふだん自分で健康だと思われますか。あてはまるものを1つだけ選んで○をつけてください。
- 非常に健康だと思ふ
 - まあ健康な方だと思ふ
 - あまり健康ではない
 - 健康ではない
- 問2 あなたは健康づくりのためにどのようなことに気をつけていますか。該当する番号に○をつけてください。(○はいくつでも)
- 食生活に気をつけている
 - 歩いたり軽い体操をしている
 - スポーツやランニングをしている
 - 休養や睡眠を十分とるようにしている
 - 酒を控えるようにしている
 - たばこを吸わないようにしている
 - 定期的に健康診断を受けるようにしている
 - 趣味や生きがいをもち、生活にメリハリを持たせるようにしている
 - 健康補助食品などを利用している
 - その他(具体的に)
 - 特に何もしていない

問3 あなたは「健康ふくしま21計画」を知っていますか。あてはまるものを1つだけ選んで○をつけてください。

- 知っている
- 聞いたことはある
- 知らない

問4 あなたは、福島県において、10月10日が「県民健康の日」であることを知っていますか。

- 知っている
- 知らない

【栄養・食生活について】

問5 あなたは、朝食をいただきたい毎日とっていますか。

- はい
- いいえ

問6 あなたは、朝食、夕食を家族とどのくらい一緒に食べていますか。

	ほとんど毎日	週に4～5日	週に2～3日	週に1日程度	ほとんどない
朝食	1	2	3	4	5
夕食	1	2	3	4	5

問7 あなたは、食育推進月間と食育の日を知っていますか。

- 1 知っている
- 2 名称は知っているが、月日までは知らなかった
- 3 知らない

問8 あなたは、日頃から栄養バランスのとれた食生活を実践していますか。

- 1 はい
- 2 いいえ

【身体活動・運動について】

問9 あなたは、ロコモティブシンドローム（運動器症候群）を知っていましたか。（〇は1つ）

- 1 知っている
- 2 知らない

ロコモティブシンドローム（運動器症候群）
骨や関節、筋肉などの運動器のおとろえや障がいで介護を必要とする状態、または必要となる可能性の高い状態をロコモティブシンドロームと呼びます。

問10 最近1年間の運動について、あてはまるものを1つ選んで〇をつけてください。

- 1 何らかの運動をほとんど毎日している（付問へ）
- 2 何らかの運動を週2～4回程度している（付問へ）
- 3 何らかの運動を週1回程度している（付問へ）
- 4 ほとんど（まったく）していない

付問 問10で1～3を選んだ方におたずねします。1回の運動時間はどれくらいですか。複数の運動をしている方は、もっとも運動時間の長いものについてお答えください。

- 1 15分未満
- 2 15～30分未満
- 3 30分以上

【喫煙について】

問11 あなたは、たばこを吸っていますか。（〇は1つ）

- 1 毎日吸う（付問へ）
- 2 時々吸う（付問へ）
- 3 今は吸っていない（禁煙に成功した）
- 4 習慣的に吸ったことがない

付問 問11で1～2を選んだ方におたずねします。あなたは、たばこをやめた
位と思いますか。（〇は1つ）

- 1 やめたい
- 2 本数を減らしたい
- 3 やめたくない
- 4 わからない

問12 あなたは家族で、あなたを含めて、たばこを吸っている方はいますか。

- 1 いる
- 2 いない

問13 あなたは、この1か月間に、自分以外の人が吸っていたたばこの煙を吸う機会（受動喫煙）がありましたか。（各項目につき、〇は1つ）

	ほぼ毎日	週に数回	週に1回	月に1回	全くなかった	いかなかった
家庭	1	2	3	4	5	6
職場	1	2	3	4	5	6
学校	1	2	3	4	5	6
飲食店	1	2	3	4	5	6
遊技場（※）	1	2	3	4	5	6
行政機関（※）	1	2	3	4	5	6
医療機関（※）	1	2	3	4	5	6
公共交通機関	1	2	3	4	5	6
路上	1	2	3	4	5	6
子供が利用する屋外の空間（※）	1	2	3	4	5	6
健康増進施設（※）	1	2	3	4	5	6

（※） 場所の説明
遊技場/ゲームセンター、パチンコ店、競艇場、競輪場など
行政機関/布役所、町村役場、公民館など
医療機関/病院、クリニックなど
子供が利用する屋外の空間/公園、通学路など
健康増進施設/トレーニングジム、体育館、プールなど

※学校、飲食店、遊技場などに勤務して、その職場で受動喫煙があった場合は、「職場」欄に記入してください。

問14 あなたは、「COPD（慢性閉塞性肺疾患）」という病気を知っていましたか。（○は1つ）

- 1 知っている 2 知らない

COPD（慢性閉塞性肺疾患）

空気の通り道である肺の気管支や肺素を取り込む肺泡で炎症が起き、気管支が狭くなったり、肺泡の壁が壊れる病気です。この病気にかかると、肺の機能が低下して十分な酸素を取り込めなくなり、息切れや、せき・たんが多くなり出たりします。原因の90%はたばこによるもので、喫煙者の20%が発症するとされています。

【飲酒について】

問15 あなたは、どのくらいお酒を飲んでいますか。あてはまる番号を1つ選んで○をつけてください。

- 1 毎日飲んでいる 2 週に5～6回飲んでいる
 3 週に3～4回飲んでいる 4 たまに飲む程度
 5 以前は飲んでいましたが、今は飲んでいない 6 もともと飲まない

付問 問15で1～4を選んだ方におたずねします。あなたが1回に飲む量はどれくらいですか。日本酒にあてはめて計算し、あてはまる番号を1つ選んで○をつけてください。（計算の仕方は、下記のとおりです。）

- 1 極少量 2 1合程度
 3 2合程度 4 3合以上

焼酎1合は・・・日本酒約1.5合に当たる。
 ビール大瓶1本は・・・日本酒約1合に当たる。
 ウイスキーダブル1杯は・・・日本酒約1合に当たる。
 ワイングラス2杯は・・・日本酒約1合に当たる。
 うすめて飲むときは、もとの量で計算してください

【歯・口腔の健康について】

問16 あなたは定期的に歯科健診（歯石の除去、歯面清掃を含む）を受けていますか。

- 1 はい 2 いいえ

問17 あなたは毎食後（1日3回以上）歯をみがいていますか。

- 1 はい 2 いいえ

【社会参加について】

問18 あなたは積極的に外出するほうですか。（外出には日常生活での買物や散歩を含めます）

- 1 はい 2 いいえ

問19 あなたは何らかの地域活動を実施していますか。あてはまる番号に○をつけてください。（○はいくつでも）

- 1 老人クラブ
 2 健康・スポーツの集まりや団体
 3 趣味の集まりや団体
 4 社会奉仕団体（ボランティア団体）
 5 町内会、自治会の活動
 6 宗教団体
 7 職場のクラブ活動など
 8 その他（具体的に： ）
 9 何も参加していない

【健診（検診）の受診について】

問20 あなたは過去1年間に、健診等（健康診断、健康診査および人間ドック）を受けたことがありますか。（○は1つ）

- 1 ある 2 ない

※ここでは、次のようなものには健診等には含まれません。
 ・がんのみ検診
 ・妊産婦健診
 ・病院や診療所で行う診療としての検査

問21 どのような機会に健診等を受けましたか。（あてはまるものすべてに○）

- 1 市町村が実施した健診
 2 勤め先、または健康保険組合等が実施した健診
 3 学校が実施した健診（学生として受診した健診）
 4 人間ドック（1～3以外の健診で行うもの）
 5 その他（ ）

問22 健診等（健康診断、健康診査および人間ドック）を受けるときに、次の項目はどのくらい重要だと感じますか。（各項目につき○は1つ）

重 要	重 要	やや 重 要	どちらとも いえない	あまり重要 でない	重要 でない
わかりやすい健診等の情報	1	2	3	4	5
受診を勧める通知	1	2	3	4	5
受診にかかる時間	1	2	3	4	5
受診場所の近さ	1	2	3	4	5
安い費用	1	2	3	4	5
職員の理解と協力	1	2	3	4	5
がん検診等の同時実施	1	2	3	4	5
健診等スタッフの対応	1	2	3	4	5
健診等スタッフの技術	1	2	3	4	5

【その他】

問23 あなたは、ふだんの睡眠時間は、どのくらいですか。あてはまる番号を1つ選んで○をつけてください。

- 1 4時間以下
- 2 5時間位
- 3 6時間位
- 4 7時間位
- 5 8時間位
- 6 9時間以上

問24 疲れすぎたと感じていますか。あてはまる番号を1つ選んで○をつけてください。

- 1 感じている
- 2 あまり感じていない
- 3 まったく感じていない

問25 あなたは、健康づくりのために何が必要と考えますか。

[]

問26 全体をとおして気付かれた点について、御自由にお書きください。

[]

記入してくださいのはどなたですか。

- 1 本人
- 2 代理人（病柄を教えてください。 [] ）

以上で終了です。お忙しいところ、ご協力ありがとうございました。
この調査票は、同封の返信用封筒（切手不要）に入れて、8月24日（金）までにポストに投かんしてください。



第2章 調査結果の概要

1 健康についての意識（満15歳以上対象）（調査票 問1の集計結果）

あなたはふだん自分で健康だと思われますか。

	全 体	男 性	女 性
1 非常に健康だと思う	336 (8.3%)	191 (9.6%)	145 (7.0%)
2 まあ健康な方だと思う	2,665 (65.5%)	1,271 (63.9%)	1,394 (67.1%)
3 あまり健康ではない	664 (16.3%)	331 (16.6%)	333 (16.0%)
4 健康ではない	267 (6.6%)	128 (6.4%)	139 (6.7%)
5 無回答	134 (3.3%)	67 (3.4%)	67 (3.2%)
合 計	4,066	1,988	2,078

【平成21年度県民健康調査】

	全 体	男 性	女 性
1 非常に健康だと思う	454 (9.8%)	239 (10.6%)	215 (9.1%)
2 まあ健康な方だと思う	3,102 (67.0%)	1,504 (66.6%)	1,598 (67.5%)
3 あまり健康ではない	688 (14.9%)	335 (14.8%)	353 (14.9%)
4 健康ではない	299 (6.5%)	146 (6.5%)	153 (6.5%)
5 無回答	85 (1.8%)	35 (1.5%)	50 (2.1%)
合 計	4,628	2,259	2,369

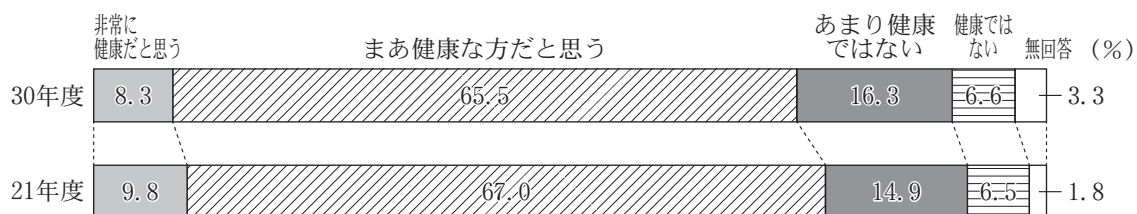

2 健康づくりのために気をつけていること（満15歳以上対象）（調査票 問2の集計結果）

あなたは健康づくりのためにどのようなことに気をつけていますか。（複数回答有）

【回答者数】 4,066人

1	食生活に気をつけている	2,314	56.9%
2	歩いたり軽い体操をしている	1,442	35.5%
3	スポーツやランニングをしている	506	12.4%
4	休養や睡眠を十分とるようにしている	1,824	44.9%
5	酒を控えるようにしている	944	23.2%
6	たばこを吸わないようにしている	1,358	33.4%
7	定期的に健康診断を受けるようにしている	1,718	42.3%
8	趣味や生きがいをもち、生活にメリハリを持たせるようにしている	1,186	29.2%
9	健康補助食品などを利用している	708	17.4%
10	その他	121	3.0%
11	特に何もしていない	418	10.3%

【平成21年度県民健康調査】

【回答者数】 4,628人

1	食生活に気をつけている	2,681	57.9%
2	歩いたり軽い体操をしている	1,662	35.9%
3	スポーツやランニングをしている	580	12.5%
4	休養や睡眠を十分とるようにしている	2,466	53.3%
5	酒を控えるようにしている	842	18.2%
6	たばこを吸わないようにしている	1,046	22.6%
7	定期的に健康診断を受けるようにしている	1,901	41.1%
8	趣味や生きがいをもち、生活にメリハリを持たせるようにしている	1,351	29.2%
9	健康補助食品などを利用している	799	17.3%
10	その他	142	3.1%
11	特に何もしていない	496	10.7%

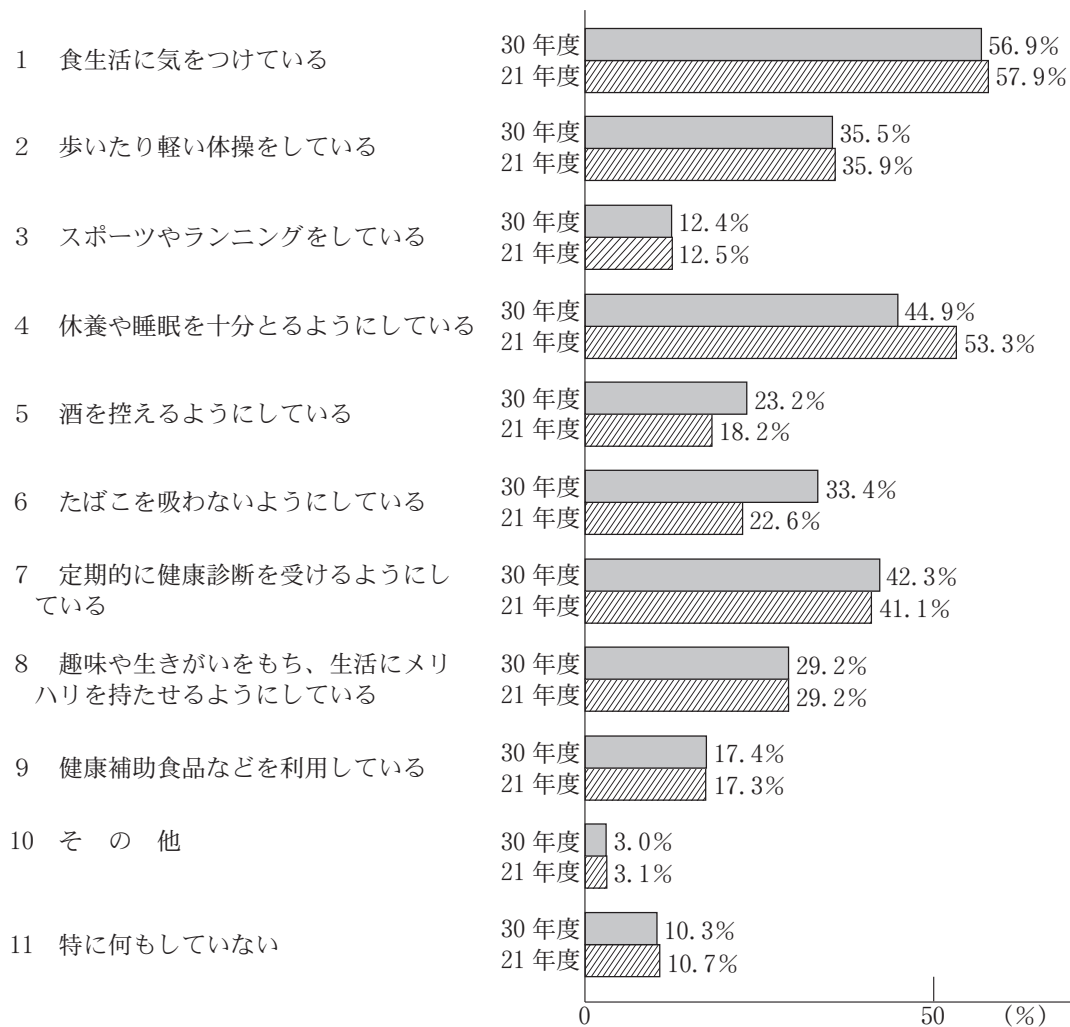

3 「健康ふくしま21計画」の認知度（満15歳以上対象）（調査票 問3の集計結果）

あなたは「健康ふくしま21計画」を知っていますか。			
	全体	男性	女性
1 知っている	197 (4.8%)	90 (4.5%)	107 (5.1%)
2 聞いたことはある	891 (21.9%)	400 (20.1%)	491 (23.6%)
3 知らない	2,863 (70.4%)	1,444 (72.6%)	1,419 (68.3%)
4 無回答	115 (2.8%)	54 (2.7%)	61 (2.9%)
合計	4,066	1,988	2,078

【平成21年度県民健康調査】			
	全体	男性	女性
1 知っている	196 (4.2%)	97 (4.3%)	99 (4.2%)
2 聞いたことはある	823 (17.8%)	418 (18.5%)	405 (17.1%)
3 知らない	3,516 (76.0%)	1,705 (75.5%)	1,811 (76.4%)
4 無回答	93 (2.0%)	39 (1.7%)	54 (2.3%)
合計	4,628	2,259	2,369

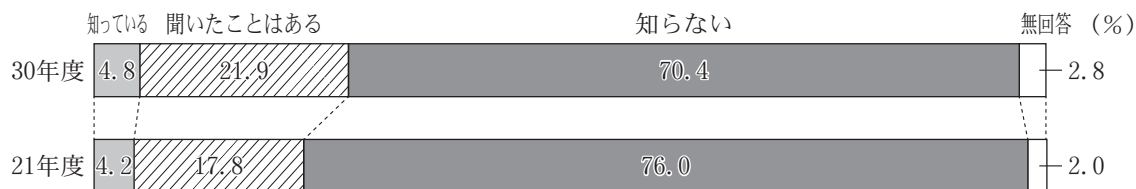

4 「県民健康の日」の認知度 (満15歳以上対象) (調査票 問4の集計結果)

あなたは、福島県において、10月10日が「県民健康の日」であることを知っていますか。

	全体	男性	女性
1 知っている	801 (19.7%)	357 (18.0%)	444 (21.4%)
2 知らない	3,151 (77.5%)	1,579 (79.4%)	1,572 (75.6%)
3 無回答	114 (2.8%)	52 (2.6%)	62 (3.0%)
合計	4,066	1,988	2,078

【平成21年度県民健康調査】

	全体	男性	女性
1 知っている	1,048 (22.6%)	498 (18.0%)	550 (23.2%)
2 知らない	3,489 (75.4%)	1,724 (79.4%)	1,765 (74.5%)
3 無回答	91 (2.0%)	37 (2.6%)	54 (2.3%)
合計	4,628	2,259	2,369



5 食生活 (朝食) の状況 (満15歳以上対象) (調査票 問5の集計結果)

あなたは、朝食をだいたい毎日とっていますか。

	全体	男性	女性
1 はい	3,465 (85.2%)	1,636 (82.3%)	1,829 (88.0%)
2 いいえ	505 (12.4%)	301 (15.1%)	204 (9.8%)
3 無回答	96 (2.4%)	51 (2.6%)	45 (2.2%)
合計	4,066	1,988	2,078

【平成21年度県民健康調査】

	全体	男性	女性
1 はい	4,075 (88.1%)	1,940 (85.9%)	2,135 (90.1%)
2 いいえ	480 (10.4%)	292 (12.9%)	188 (7.9%)
3 無回答	73 (1.6%)	27 (1.2%)	46 (1.9%)
合計	4,628	2,259	2,369

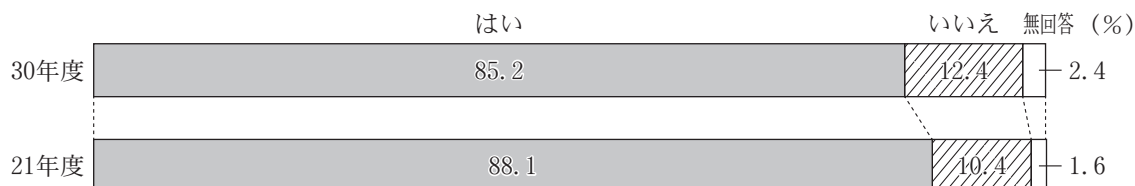

6 食生活（朝食・夕食）の状況（満15歳以上対象）（調査票 問6の集計結果）

あなたは、朝食を家族とどのくらい一緒に食べていますか。

	全 体	男 性	女 性
1 ほとんど毎日	2,134 (52.5%)	1,032 (51.9%)	1,102 (53.0%)
2 週に4～5日	181 (4.5%)	97 (4.9%)	84 (4.0%)
3 週に2～3日	271 (6.7%)	135 (6.8%)	136 (6.5%)
4 週に1日程度	229 (5.6%)	121 (6.1%)	108 (5.2%)
5 ほとんどない	1,004 (24.7%)	497 (25.0%)	507 (24.4%)
6 無回答	247 (6.1%)	106 (5.3%)	141 (6.8%)
合 計	4,066	1,988	2,078

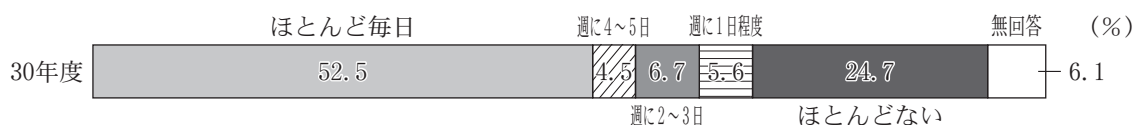

あなたは、夕食を家族とどのくらい一緒に食べていますか。

	全 体	男 性	女 性
1 ほとんど毎日	2,520 (62.0%)	1,177 (59.2%)	1,343 (64.6%)
2 週に4～5日	276 (6.8%)	155 (7.8%)	121 (5.8%)
3 週に2～3日	349 (8.6%)	206 (10.4%)	143 (6.9%)
4 週に1日程度	134 (3.3%)	82 (4.1%)	52 (2.5%)
5 ほとんどない	543 (13.4%)	259 (13.0%)	284 (13.7%)
6 無回答	244 (6.0%)	109 (5.5%)	135 (6.5%)
合 計	4,066	1,988	2,078



7 「食育推進月間」「食育の日」の認知度（満15歳以上対象）（調査票 問7の集計結果）

あなたは、食育推進月間と食育の日を知っていますか。

	全 体	男 性	女 性
1 知っている	152 (3.7%)	50 (2.5%)	102 (4.9%)
2 名称は知っているが、月日までは知らなかった	955 (23.5%)	338 (17.0%)	617 (29.7%)
3 知らない	2,827 (69.5%)	1,540 (77.5%)	1,287 (61.9%)
4 無回答	132 (3.2%)	60 (3.0%)	72 (3.5%)
合 計	4,066	1,988	2,078

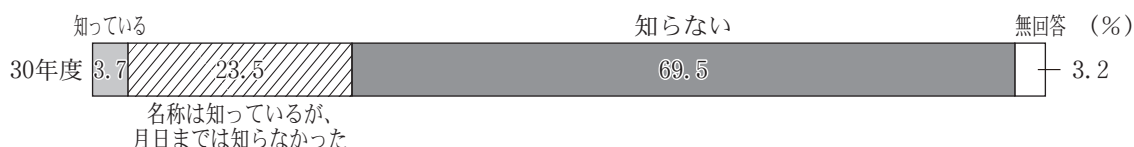

8 食生活（栄養バランス）の状況（満15歳以上対象）（調査票 問8の調査結果）

あなたは、日頃から栄養バランスのとれた食生活を実践していますか。

	全 体	男 性	女 性
1 はい	2,442 (60.1%)	1,088 (54.7%)	1,354 (65.2%)
2 いいえ	1,485 (36.5%)	834 (42.0%)	651 (31.3%)
3 無回答	139 (3.4%)	66 (3.3%)	73 (3.5%)
合 計	4,066	1,988	2,078



9 「ロコモティブシンドローム」の認知度（満15歳以上対象）（調査票 問9の調査結果）

あなたは、ロコモティブシンドローム（運動器症候群）を知っていましたか。

	全 体	男 性	女 性
1 知っている	947 (23.3%)	325 (16.3%)	622 (29.9%)
2 知らない	2,996 (73.7%)	1,606 (80.8%)	1,390 (66.9%)
3 無回答	123 (3.0%)	57 (2.9%)	66 (3.2%)
合 計	4,066	1,988	2,078



10 最近1年間の運動状況

(1) 最近1年間の運動状況（満15歳以上対象）（調査票 問10の調査結果）

最近1年間の運動状況について			
	全 体	男 性	女 性
1 何らかの運動をほとんど毎日している	636 (15.6%)	357 (18.0%)	279 (13.4%)
2 何らかの運動を週2～4回程度している	833 (20.5%)	393 (19.8%)	440 (21.2%)
3 何らかの運動を週1回程度している	700 (17.2%)	343 (17.3%)	357 (17.2%)
4 ほとんど（まったく）していない	1,764 (43.4%)	831 (41.8%)	933 (44.9%)
5 無回答	133 (3.3%)	64 (3.2%)	69 (3.3%)
合 計	4,066	1,988	2,078

【平成21年度県民健康調査】			
	全 体	男 性	女 性
1 何らかの運動をほとんど毎日している	779 (16.8%)	419 (18.5%)	360 (15.2%)
2 何らかの運動を週2～4回程度している	714 (15.4%)	339 (15.0%)	375 (15.8%)
3 何らかの運動を週1回程度している	808 (17.5%)	426 (18.9%)	382 (16.1%)
4 ほとんど（まったく）していない	2,150 (46.5%)	1,000 (44.3%)	1,150 (48.5%)
5 無回答	177 (3.8%)	75 (3.3%)	102 (4.3%)
合 計	4,628	2,259	2,369

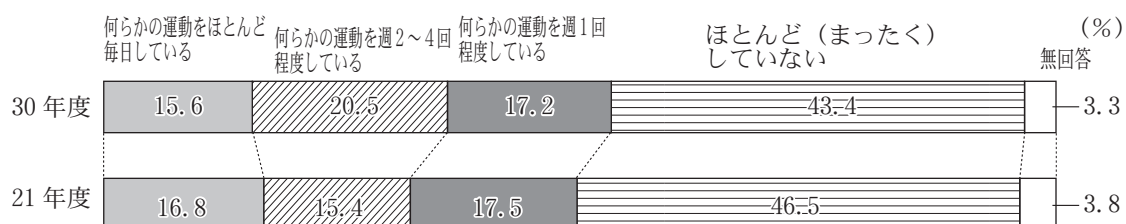

(2) 運動時間（満15歳以上対象）（調査票 問10付問の調査結果）

運動時間について			
	全 体	男 性	女 性
1 15分未満	445 (20.5%)	174 (15.9%)	271 (25.2%)
2 15～30分未満	625 (28.8%)	307 (28.1%)	318 (29.6%)
3 30分以上	1,065 (49.1%)	594 (54.3%)	471 (43.8%)
4 無回答	34 (1.6%)	18 (1.6%)	16 (1.5%)
合 計	2,169	1,093	1,076

【平成21年度県民健康調査】

	全 体	男 性	女 性
1 15分未満	446 (19.4%)	181 (15.3%)	265 (23.7%)
2 15～30分未満	597 (25.9%)	293 (24.7%)	304 (27.2%)
3 30分以上	1,204 (52.3%)	688 (58.1%)	516 (46.2%)
4 無回答	54 (2.3%)	22 (1.9%)	32 (2.9%)
合 計	2,301	1,184	1,117

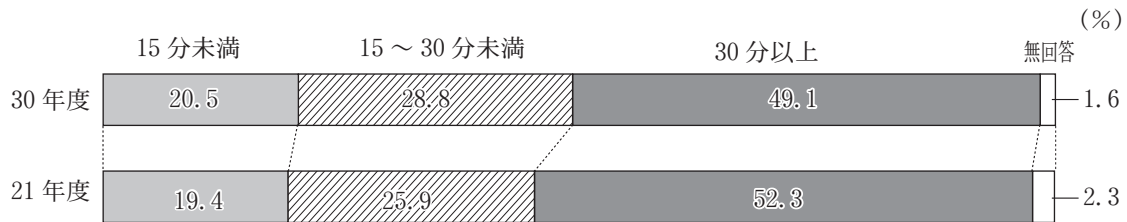

(3) 運動習慣の状況 (満20歳以上対象) (調査票 問10、問10付問の回答に関するクロス集計)

運動習慣について

- 1 何らかの運動をほとんど毎日、30分以上している
- 2 何らかの運動を週2～4回程度、30分以上している

	全 体	男 性	女 性
1	276 (7.0%)	173 (9.0%)	103 (5.1%)
2	399 (10.2%)	207 (10.8%)	192 (9.6%)
【回答者数】	3,922	1,912	2,010

【平成21年度県民健康調査】

- 1 何らかの運動をほとんど毎日、30分以上している
- 2 何らかの運動を週2～4回程度、30分以上している

	全 体	男 性	女 性
1	357 (8.1%)	215 (10.1%)	142 (6.2%)
2	361 (8.2%)	201 (9.4%)	160 (7.0%)
【回答者数】	4,413	2,139	2,274

11 喫煙の状況

(1) 喫煙の有無（満20歳以上対象）（調査票 問11の集計結果）

あなたは、たばこを吸っていますか。				
	全 体	男 性	女 性	
1 毎日吸う	634 (16.2%)	502 (26.3%)	132 (6.6%)	
2 時々吸う	67 (1.7%)	52 (2.7%)	15 (0.7%)	
3 今は吸っていない	984 (25.1%)	768 (40.2%)	216 (10.7%)	
4 習慣的に吸ったことがない	2,036 (51.9%)	523 (27.4%)	1,513 (75.3%)	
5 無回答	201 (5.1%)	67 (3.5%)	134 (6.7%)	
合 計	3,922	1,912	2,010	

【平成21年度県民健康調査】				
	全 体	男 性	女 性	
1 吸っている	983 (22.3%)	755 (35.3%)	228 (10.0%)	
2 以前は吸っていたが、今はやめた	823 (18.6%)	671 (31.4%)	152 (6.7%)	
3 吸わない	2,545 (57.7%)	690 (32.3%)	1,855 (81.6%)	
4 無回答	62 (1.4%)	23 (1.1%)	39 (1.7%)	
合 計	4,413	2,139	2,274	

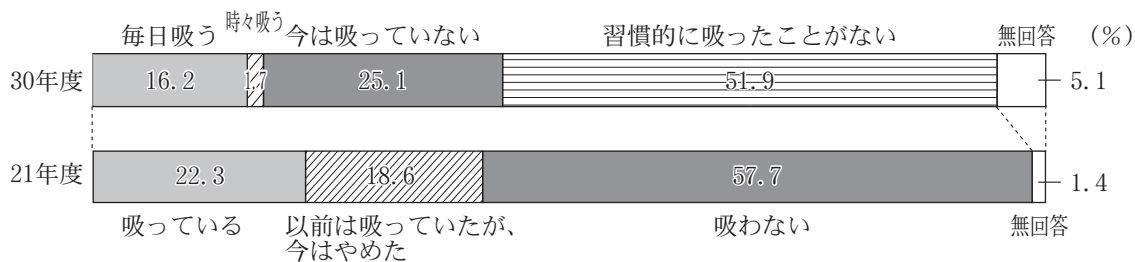

(2) 禁煙の意思（満20歳以上対象）（調査票 問11付問の調査結果）

あなたは、たばこをやめたいと思いますか。

	全 体	男 性	女 性
1 やめたい	176 (25.1%)	129 (23.3%)	47 (32.0%)
2 本数を減らしたい	237 (33.8%)	203 (36.6%)	34 (23.1%)
3 やめたくない	163 (23.3%)	129 (23.3%)	34 (23.1%)
4 わからない	113 (16.1%)	84 (15.2%)	29 (19.7%)
5 無回答	12 (1.7%)	9 (1.6%)	3 (2.0%)
合 計	701	554	147



(3) 家族（世帯）の喫煙状況（調査票 問12の集計結果）

あなたの家族で、あなたを含めて、たばこを吸っている方はいますか。

	全体数	割合
1 い る	742世帯	(35.2%)
2 い ない	1,319世帯	(62.7%)
3 無回答	44世帯	(2.1%)
合 計	2,105世帯	

【平成21年度県民健康調査】

	全体数	割合
1 い る	938世帯	(45.7%)
2 い ない	1,094世帯	(53.3%)
3 無回答	19世帯	(0.9%)
合 計	2,051世帯	

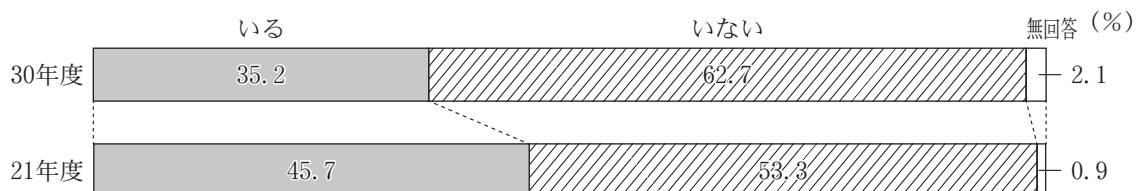

13 受動喫煙の有無（満15歳以上対象）（調査票 問13の集計結果）

問13 あなたは、この1か月間に、自分以外の人が吸っていたたばこの煙を吸う機会（受動喫煙）がありましたか。

○家庭

	全 体	男 性	女 性
1 ほぼ毎日	402 (9.9%)	160 (8.0%)	242 (11.6%)
2 週に数回程度	114 (2.8%)	48 (2.4%)	66 (3.2%)
3 週に1回程度	85 (2.1%)	29 (1.5%)	56 (2.7%)
4 月に1回程度	91 (2.2%)	37 (1.9%)	54 (2.6%)
5 全くなかった	1,929 (47.4%)	977 (49.1%)	952 (45.8%)
6 いかなかった	618 (15.2%)	308 (15.5%)	310 (14.9%)
7 無回答	827 (20.3%)	429 (21.6%)	398 (19.2%)
合 計	4,066	1,988	2,078

○職 場

	全 体	男 性	女 性
1 ほぼ毎日	447 (11.0%)	346 (17.4%)	101 (4.9%)
2 週に数回程度	225 (5.5%)	164 (8.2%)	61 (2.9%)
3 週に1回程度	113 (2.8%)	72 (3.6%)	41 (2.0%)
4 月に1回程度	116 (2.9%)	75 (3.8%)	41 (2.0%)
5 全くなかった	993 (24.4%)	428 (21.5%)	565 (27.2%)
6 いかなかった	931 (22.9%)	370 (18.6%)	561 (27.0%)
7 無回答	1,241 (30.5%)	533 (26.8%)	708 (34.1%)
合 計	4,066	1,988	2,078

○学 校

	全 体	男 性	女 性
1 ほぼ毎日	12 (0.3%)	7 (0.4%)	5 (0.2%)
2 週に数回程度	11 (0.3%)	6 (0.3%)	5 (0.2%)
3 週に1回程度	11 (0.3%)	6 (0.3%)	5 (0.2%)
4 月に1回程度	16 (0.4%)	7 (0.4%)	9 (0.4%)
5 全くなかった	667 (16.4%)	318 (16.0%)	349 (16.8%)
6 いかなかった	1,641 (40.4%)	799 (40.2%)	842 (40.5%)
7 無回答	1,708 (42.0%)	845 (42.5%)	863 (41.5%)
合 計	4,066	1,988	2,078

○飲食店

	全 体	男 性	女 性
1 ほぼ毎日	42 (1.0%)	25 (1.3%)	17 (0.8%)
2 週に数回程度	119 (2.9%)	83 (4.2%)	36 (1.7%)
3 週に1回程度	179 (4.4%)	122 (6.1%)	57 (2.7%)
4 月に1回程度	552 (13.6%)	295 (14.8%)	257 (12.4%)
5 全くなかった	1,082 (26.6%)	483 (24.3%)	599 (28.8%)
6 いかなかった	811 (19.9%)	378 (19.0%)	433 (20.8%)
7 無回答	1,281 (31.5%)	602 (30.3%)	679 (32.7%)
合 計	4,066	1,988	2,078

○遊技場

	全 体	男 性	女 性
1 ほぼ毎日	40 (1.0%)	31 (1.6%)	9 (0.4%)
2 週に数回程度	96 (2.4%)	78 (3.9%)	18 (0.9%)
3 週に1回程度	122 (3.0%)	94 (4.7%)	28 (1.3%)
4 月に1回程度	154 (3.8%)	102 (5.1%)	52 (2.5%)
5 全くなかった	547 (13.5%)	253 (12.7%)	294 (14.1%)
6 いかなかった	1,667 (41.0%)	764 (38.4%)	903 (43.5%)
7 無回答	1,440 (35.4%)	666 (33.5%)	774 (37.2%)
合 計	4,066	1,988	2,078

○行政機関

	全 体	男 性	女 性
1 ほぼ毎日	16 (0.4%)	10 (0.5%)	6 (0.3%)
2 週に数回程度	15 (0.4%)	14 (0.7%)	1 (0.0%)
3 週に1回程度	10 (0.2%)	5 (0.3%)	5 (0.2%)
4 月に1回程度	82 (2.0%)	48 (2.4%)	34 (1.6%)
5 全くなかった	989 (24.3%)	487 (24.5%)	502 (24.2%)
6 いかなかった	1,491 (36.7%)	723 (36.4%)	768 (37.0%)
7 無回答	1,463 (36.0%)	701 (35.3%)	762 (36.7%)
合 計	4,066	1,988	2,078

○医療機関

	全 体	男 性	女 性
1 ほぼ毎日	12 (0.3%)	9 (0.5%)	3 (0.1%)
2 週に数回程度	13 (0.3%)	9 (0.5%)	4 (0.2%)
3 週に1回程度	9 (0.2%)	3 (0.2%)	6 (0.3%)
4 月に1回程度	65 (1.6%)	43 (2.2%)	22 (1.1%)
5 全くなかった	1,396 (34.3%)	650 (32.7%)	746 (35.9%)
6 いかなかった	1,145 (28.2%)	580 (29.2%)	565 (27.2%)
7 無回答	1,426 (35.1%)	694 (34.9%)	732 (35.2%)
合 計	4,066	1,988	2,078

○公共交通機関

	全 体	男 性	女 性
1 ほぼ毎日	14 (0.3%)	11 (0.6%)	3 (0.1%)
2 週に数回程度	19 (0.5%)	13 (0.7%)	6 (0.3%)
3 週に1回程度	27 (0.7%)	18 (0.9%)	9 (0.4%)
4 月に1回程度	106 (2.6%)	66 (3.3%)	40 (1.9%)
5 全くなかった	1,159 (28.5%)	557 (28.0%)	602 (29.0%)
6 いかなかった	1,301 (32.0%)	637 (32.0%)	664 (32.0%)
7 無回答	1,440 (35.4%)	686 (34.5%)	754 (36.3%)
合 計	4,066	1,988	2,078

○路 上

	全 体	男 性	女 性
1 ほぼ毎日	53 (1.3%)	28 (1.4%)	25 (1.2%)
2 週に数回程度	155 (3.8%)	89 (4.5%)	66 (3.2%)
3 週に1回程度	171 (4.2%)	100 (5.0%)	71 (3.4%)
4 月に1回程度	372 (9.1%)	188 (9.5%)	184 (8.9%)
5 全くなかった	1,339 (32.9%)	647 (32.5%)	692 (33.3%)
6 いかなかった	640 (15.7%)	298 (15.0%)	342 (16.5%)
7 無回答	1,336 (32.9%)	638 (32.1%)	698 (33.6%)
合 計	4,066	1,988	2,078

○子供が利用する屋外の空間

	全 体	男 性	女 性
1 ほぼ毎日	15 (0.4%)	7 (0.4%)	8 (0.4%)
2 週に数回程度	19 (0.5%)	14 (0.7%)	5 (0.2%)
3 週に1回程度	22 (0.5%)	12 (0.6%)	10 (0.5%)
4 月に1回程度	58 (1.4%)	28 (1.4%)	30 (1.4%)
5 全くなかった	904 (22.2%)	447 (22.5%)	457 (22.0%)
6 いかなかった	1,512 (37.2%)	745 (37.5%)	767 (36.9%)
7 無回答	1,536 (37.8%)	735 (37.0%)	801 (38.5%)
合 計	4,066	1,988	2,078

○健康増進施設

	全 体	男 性	女 性
1 ほぼ毎日	6 (0.1%)	3 (0.2%)	3 (0.1%)
2 週に数回程度	8 (0.2%)	5 (0.3%)	3 (0.1%)
3 週に1回程度	14 (0.3%)	11 (0.6%)	3 (0.1%)
4 月に1回程度	25 (0.6%)	18 (0.9%)	7 (0.3%)
5 全くなかった	782 (19.2%)	380 (19.1%)	402 (19.3%)
6 いかなかった	1,672 (41.1%)	820 (41.2%)	852 (41.0%)
7 無回答	1,559 (38.3%)	751 (37.8%)	808 (38.9%)
合 計	4,066	1,988	2,078

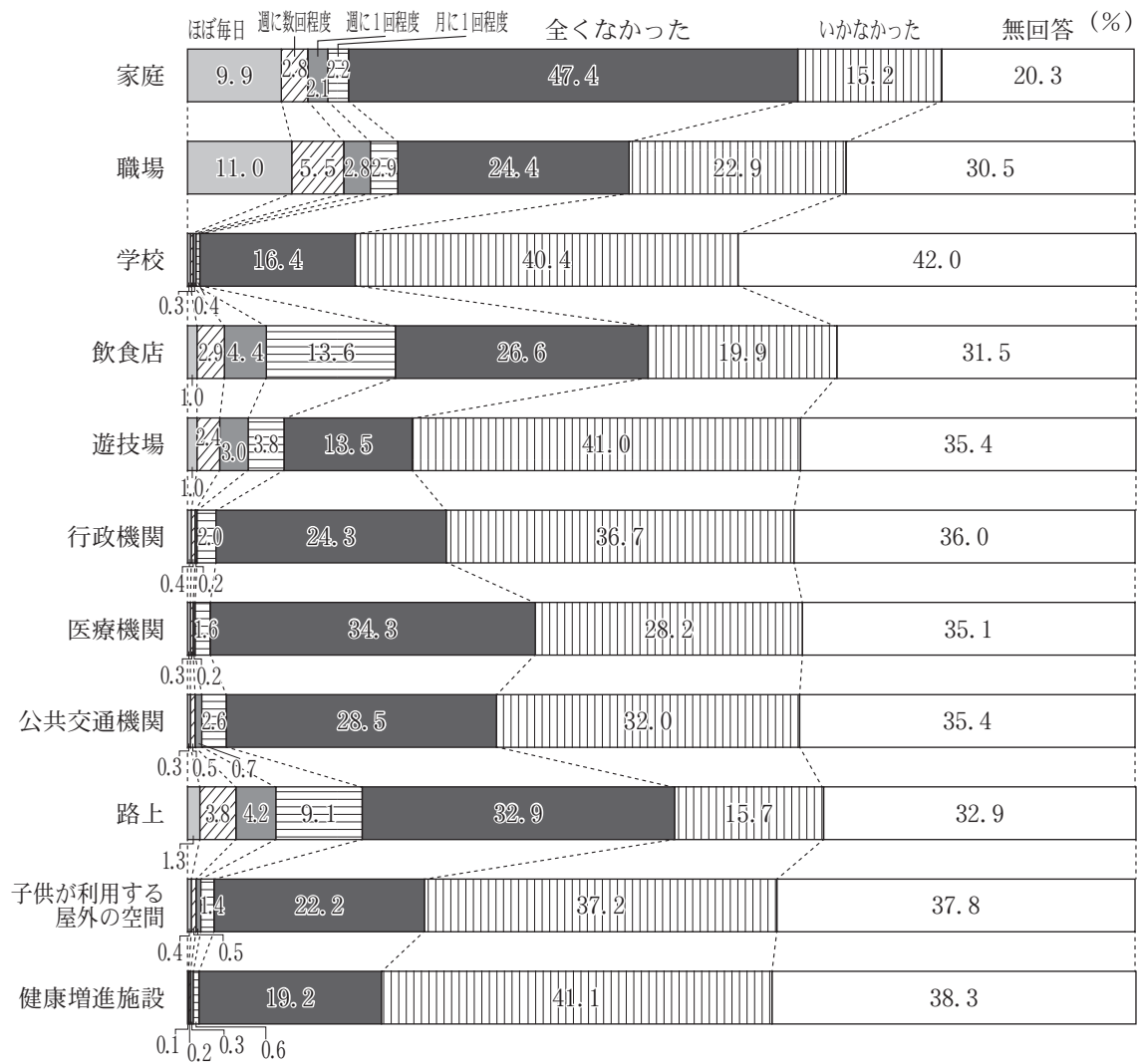

14 「COPD（慢性閉塞性肺疾患）」の認知度（満15歳以上対象）（調査票 問14の集計結果）

あなたは、「COPD（慢性閉塞性肺疾患）」という病気を知っていましたか。

	全体	男性	女性
1 知っている	1,031 (25.4%)	418 (21.0%)	613 (29.5%)
2 知らない	2,872 (70.6%)	1,500 (75.5%)	1,372 (66.0%)
3 無回答	163 (4.0%)	70 (3.5%)	93 (4.5%)
合計	4,066	1,988	2,078



15 飲酒の状況（満20歳以上対象）（調査票 問15の集計結果）

(1) 飲酒の頻度

あなたは、どのくらいお酒を飲んでいますか。

	全 体	男 性	女 性
1 毎日飲んでいる	721 (18.4%)	581 (30.4%)	140 (7.0%)
2 週に5～6回飲んでいる	191 (4.9%)	142 (7.4%)	49 (2.4%)
3 週に3～4回飲んでいる	264 (6.7%)	178 (9.3%)	86 (4.3%)
4 たまに飲む程度	1,099 (28.0%)	499 (26.1%)	600 (29.9%)
5 以前は飲んでいたが、今は飲んでいない	310 (7.9%)	168 (8.8%)	142 (7.1%)
6 もともと飲まない	1,187 (30.3%)	284 (14.9%)	903 (44.9%)
7 無回答	150 (3.8%)	60 (3.1%)	90 (4.5%)
合 計	3,922	1,912	2,010

【平成21年度県民健康調査】

	全 体	男 性	女 性
1 毎日飲んでいる	777 (17.6%)	655 (30.6%)	122 (5.4%)
2 週に5～6回飲んでいる	224 (5.1%)	171 (8.0%)	53 (2.3%)
3 週に3～4回飲んでいる	268 (6.1%)	178 (8.3%)	90 (4.0%)
4 たまに飲む程度	1,208 (27.4%)	548 (25.6%)	660 (29.0%)
5 以前は飲んでいたが、今は飲んでいない	366 (8.3%)	206 (9.6%)	160 (7.0%)
6 もともと飲まない	1,442 (32.7%)	343 (16.0%)	1,099 (48.3%)
7 無回答	128 (2.9%)	38 (1.8%)	90 (4.0%)
合 計	4,413	2,139	2,274

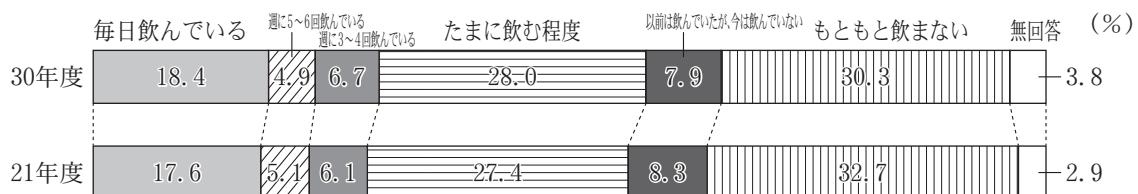

(2) 飲むお酒の量（満20歳以上対象）（調査票 問15付問の集計結果）

あなたが1回に飲む量はどれくらいですか。

	全 体	男 性	女 性
1 極少量	707 (31.1%)	257 (18.4%)	450 (51.4%)
2 1合程度	833 (36.6%)	541 (38.6%)	292 (33.4%)
3 2合程度	528 (23.2%)	437 (31.2%)	91 (10.4%)
4 3合以上	174 (7.6%)	152 (10.9%)	22 (2.5%)
5 無回答	33 (1.5%)	13 (0.9%)	20 (2.3%)
合 計	2,275	1,400	875

【平成21年度県民健康調査】

	全 体	男 性	女 性
1 極少量	747 (30.2%)	266 (17.1%)	481 (52.0%)
2 1合程度	923 (37.3%)	607 (39.1%)	316 (34.2%)
3 2合程度	576 (23.3%)	494 (31.8%)	82 (8.9%)
4 3合以上	195 (7.9%)	166 (10.7%)	29 (3.1%)
5 無回答	36 (1.5%)	19 (1.2%)	17 (1.8%)
合 計	2,477	1,552	925

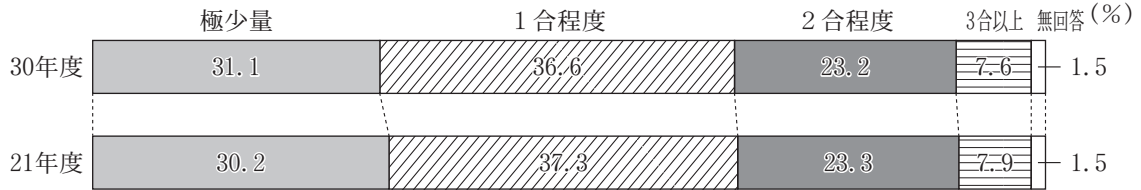

16 定期的な歯科検診（満15歳以上対象）（調査票 問16の集計結果）

あなたは定期的に歯科健診（歯石の除去、歯面清掃を含む）を受けていますか。

	全 体	男 性	女 性
1 はい	1,255 (30.9%)	526 (26.5%)	729 (35.1%)
2 いいえ	2,665 (65.5%)	1,395 (70.2%)	1,270 (61.1%)
3 無回答	146 (3.6%)	67 (3.4%)	79 (3.8%)
合 計	4,066	1,988	2,078

【平成21年度県民健康調査】

	全 体	男 性	女 性
1 はい	875 (18.9%)	381 (16.9%)	494 (20.9%)
2 いいえ	3,645 (78.8%)	1,824 (80.7%)	791 (33.4%)
3 無回答	138 (3.0%)	54 (2.4%)	84 (3.5%)
合 計	4,628	2,259	2,369

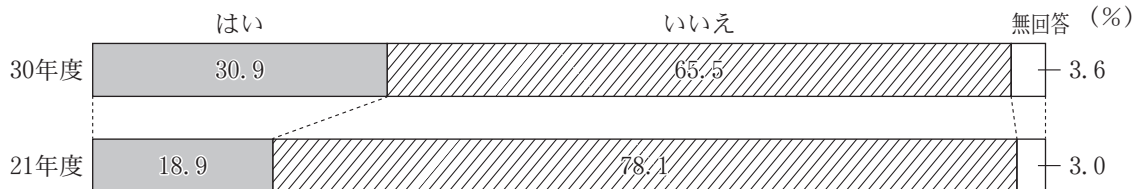

17 歯みがきの状況（満15歳以上対象）（調査票 問17の集計結果）

あなたは毎食後（1日3回以上）歯をみがいていますか。

	全 体	男 性	女 性
1 はい	1,505 (37.0%)	564 (28.4%)	941 (45.3%)
2 いいえ	2,414 (59.4%)	1,353 (68.1%)	1,061 (51.1%)
3 無回答	147 (3.6%)	71 (3.6%)	76 (3.7%)
合 計	4,066	1,988	2,078

【平成21年度県民健康調査】

	全 体	男 性	女 性
1 はい	1,452 (31.4%)	545 (24.1%)	907 (38.3%)
2 いいえ	3,066 (66.2%)	1,670 (73.9%)	1,396 (58.9%)
3 無回答	110 (2.4%)	44 (1.9%)	66 (2.8%)
合 計	4,628	2,259	2,369

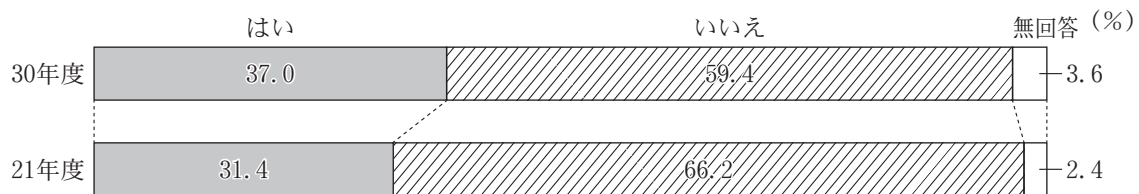

18 外出の状況（満15歳以上対象）（調査票 問18の集計結果）

あなたは積極的に外出するほうですか（買物や散歩を含む）。

	全 体	男 性	女 性
1 はい	2,742 (67.4%)	1,327 (66.8%)	1,415 (68.1%)
2 いいえ	1,183 (29.1%)	589 (29.6%)	594 (28.6%)
3 無回答	141 (3.5%)	72 (3.6%)	69 (3.3%)
合 計	4,066	1,988	2,078

【平成21年度県民健康調査】

	全 体	男 性	女 性
1 はい	3,362 (72.6%)	1,622 (71.8%)	1,740 (73.4%)
2 いいえ	1,141 (24.7%)	577 (25.5%)	564 (23.8%)
3 無回答	125 (2.7%)	60 (2.7%)	65 (2.7%)
合 計	4,628	2,259	2,369

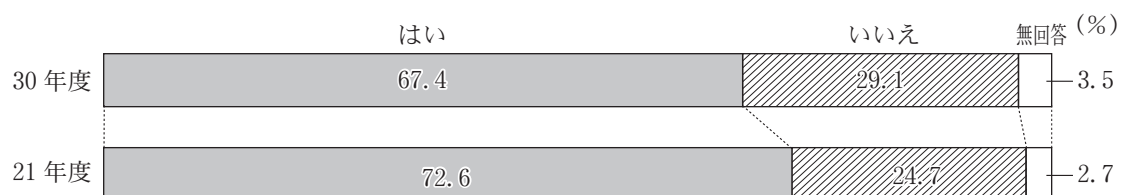

*60歳以上			
	全 体	男 性	女 性
1 はい	1,465 (66.9%)	723 (68.1%)	742 (65.8%)
2 いいえ	638 (29.1%)	294 (27.7%)	344 (30.5%)
3 無回答	86 (3.9%)	44 (4.1%)	42 (3.7%)
合 計	2,189	1,061	1,128

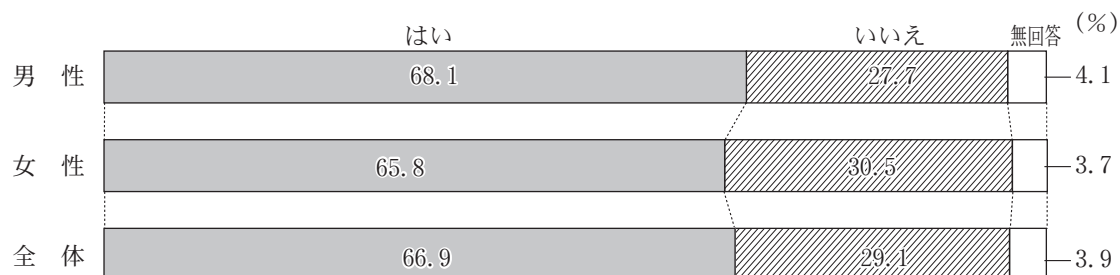

19 地域活動の実施状況（満15歳以上対象）（調査票 問19の集計結果）

あなたは何らかの地域活動を実施していますか。（複数回答有）

【回答者数】 4,066人

1 老人クラブ	204 (5.0%)
2 健康・スポーツの集まりや団体	521 (12.8%)
3 趣味の集まりや団体	622 (15.3%)
4 社会奉仕団体（ボランティア団体）	238 (5.9%)
5 町内会、自治会の活動	631 (15.5%)
6 宗教団体	83 (2.0%)
7 職場のクラブ活動など	94 (2.3%)
8 その他	133 (3.3%)
9 何も参加していない	2,150 (52.9%)

【平成21年度県民健康調査】

【回答者数】 4,628人

1 老人クラブ	292 (6.3%)
2 健康・スポーツの集まりや団体	502 (10.8%)
3 趣味の集まりや団体	589 (12.7%)
4 社会奉仕団体（ボランティア団体）	276 (6.0%)
5 町内会、自治会の活動	604 (13.1%)
6 宗教団体	124 (2.7%)
7 職場のクラブ活動など	130 (2.8%)
8 その他	143 (3.1%)
9 何も参加していない	2,545 (55.0%)

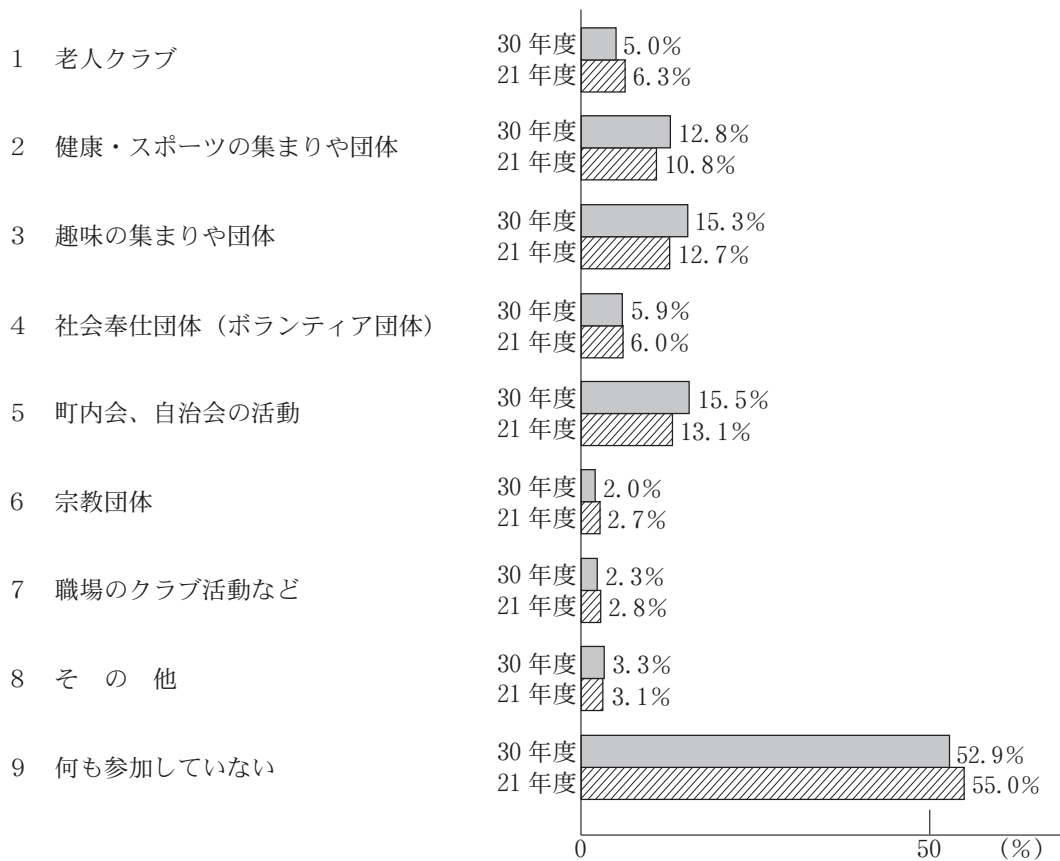

20 健診（検診）受診の状況（満15歳以上対象）（調査票 問20の集計結果）

あなたは過去1年間に、健診等（健康診断、健康診査および人間ドック）を受けたことがありますか。

	全体	男性	女性
1 ある	2,944 (72.4%)	1,498 (75.4%)	1,446 (69.6%)
2 ない	971 (23.9%)	421 (21.2%)	550 (26.5%)
3 無回答	151 (3.7%)	69 (3.5%)	82 (3.9%)
合計	4,066	1,988	2,078



21 健診（検診）受診の機会（満15歳以上対象）（調査票 問21の集計結果）

どのような機会に健診等を受けましたか。（複数回答有）
【回答者数】 4,066人

	全 体	男 性	女 性
1 市町村が実施した健診	1,291 (31.8%)	534 (26.9%)	757 (36.4%)
2 勤め先、または健康保険組合等が実施した健診	1,595 (39.2%)	906 (45.6%)	689 (33.2%)
3 学校が実施した健診（学生として受診した健診）	144 (3.5%)	69 (3.5%)	75 (3.6%)
4 人間ドック（1～3以外の健診で行うもの）	187 (4.6%)	102 (5.1%)	85 (4.1%)
5 その他	230 (5.7%)	104 (5.2%)	126 (6.1%)

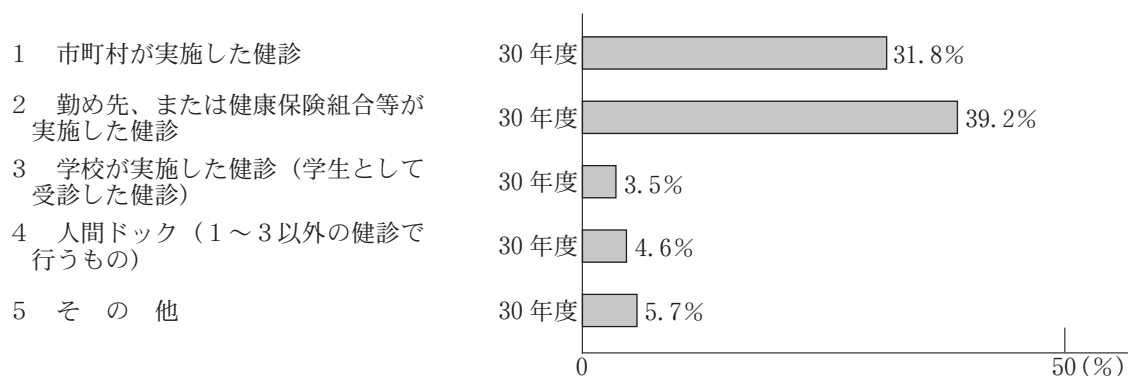

22 健診（検診）の際、重要視する点（満15歳以上対象）（調査票 問22の集計結果）

健診等（健康診断、健康診査および人間ドック）を受けるときに、次の項目はどのくらい重要だと思いますか。

〇わかりやすい健診等の情報

	全 体	男 性	女 性
1 重 要	2,288 (56.3%)	1,082 (54.4%)	1,206 (58.0%)
2 やや重要	769 (18.9%)	394 (19.8%)	375 (18.0%)
3 どちらともいえない	281 (6.9%)	160 (8.0%)	121 (5.8%)
4 あまり重要でない	50 (1.2%)	30 (1.5%)	20 (1.0%)
5 重要でない	24 (0.6%)	15 (0.8%)	9 (0.4%)
6 無回答	654 (16.1%)	307 (15.4%)	347 (16.7%)
合 計	4,066	1,988	2,078

○受診を勧める通知

	全 体	男 性	女 性
1 重 要	1,822 (44.8%)	837 (42.1%)	985 (47.4%)
2 やや重要	945 (23.2%)	466 (23.4%)	479 (23.1%)
3 どちらともいえない	442 (10.9%)	265 (13.3%)	177 (8.5%)
4 あまり重要でない	81 (2.0%)	48 (2.4%)	33 (1.6%)
5 重要でない	43 (1.1%)	30 (1.5%)	13 (0.6%)
6 無回答	733 (18.0%)	342 (17.2%)	391 (18.8%)
合 計	4,066	1,988	2,078

○受診にかかる時間

	全 体	男 性	女 性
1 重 要	1,524 (37.5%)	700 (35.2%)	824 (39.7%)
2 やや重要	1,023 (25.2%)	496 (24.9%)	527 (25.4%)
3 どちらともいえない	545 (13.4%)	301 (15.1%)	244 (11.7%)
4 あまり重要でない	142 (3.5%)	86 (4.3%)	56 (2.7%)
5 重要でない	49 (1.2%)	34 (1.7%)	15 (0.7%)
6 無回答	783 (19.3%)	371 (18.7%)	412 (19.8%)
合 計	4,066	1,988	2,078

○受診場所の近さ

	全 体	男 性	女 性
1 重 要	1,711 (42.1%)	755 (38.0%)	956 (46.0%)
2 やや重要	1,049 (25.8%)	532 (26.8%)	517 (24.9%)
3 どちらともいえない	397 (9.8%)	233 (11.7%)	164 (7.9%)
4 あまり重要でない	111 (2.7%)	73 (3.7%)	38 (1.8%)
5 重要でない	40 (1.0%)	31 (1.6%)	9 (0.4%)
6 無回答	758 (18.6%)	364 (18.3%)	394 (19.0%)
合 計	4,066	1,988	2,078

○安い費用

	全 体	男 性	女 性
1 重 要	2,150 (52.9%)	1,005 (50.6%)	1,145 (55.1%)
2 やや重要	756 (18.6%)	395 (19.9%)	361 (17.4%)
3 どちらともいえない	324 (8.0%)	176 (8.9%)	148 (7.1%)
4 あまり重要でない	64 (1.6%)	41 (2.1%)	23 (1.1%)
5 重要でない	30 (0.7%)	20 (1.0%)	10 (0.5%)
6 無回答	742 (18.2%)	351 (17.7%)	391 (18.8%)
合 計	4,066	1,988	2,078

○職場の理解と協力

	全 体	男 性	女 性
1 重 要	1,706 (42.0%)	831 (41.8%)	875 (42.1%)
2 やや重要	679 (16.7%)	358 (18.0%)	321 (15.4%)
3 どちらともいえない	392 (9.6%)	200 (10.1%)	192 (9.2%)
4 あまり重要でない	50 (1.2%)	29 (1.5%)	21 (1.0%)
5 重要でない	55 (1.4%)	31 (1.6%)	24 (1.2%)
6 無回答	1,184 (29.1%)	539 (27.1%)	645 (31.0%)
合 計	4,066	1,988	2,078

○がん検診等の同時実施

	全 体	男 性	女 性
1 重 要	1,989 (48.9%)	937 (47.1%)	1,052 (50.6%)
2 やや重要	800 (19.7%)	417 (21.0%)	383 (18.4%)
3 どちらともいえない	380 (9.3%)	213 (10.7%)	167 (8.0%)
4 あまり重要でない	26 (0.6%)	12 (0.6%)	14 (0.7%)
5 重要でない	31 (0.8%)	18 (0.9%)	13 (0.6%)
6 無回答	840 (20.7%)	391 (19.7%)	449 (21.6%)
合 計	4,066	1,988	2,078

○健診等スタッフの対応

	全 体	男 性	女 性
1 重 要	1,827 (44.9%)	825 (41.5%)	1,002 (48.2%)
2 やや重要	961 (23.6%)	494 (24.8%)	467 (22.5%)
3 どちらともいえない	384 (9.4%)	226 (11.4%)	158 (7.6%)
4 あまり重要でない	61 (1.5%)	37 (1.9%)	24 (1.2%)
5 重要でない	30 (0.7%)	23 (1.2%)	7 (0.3%)
6 無回答	803 (19.7%)	383 (19.3%)	420 (20.2%)
合 計	4,066	1,988	2,078

○健診等スタッフの技術

	全 体	男 性	女 性
1 重 要	2,270 (55.8%)	1,067 (53.7%)	1,203 (57.9%)
2 やや重要	694 (17.1%)	359 (18.1%)	335 (16.1%)
3 どちらともいえない	259 (6.4%)	153 (7.7%)	106 (5.1%)
4 あまり重要でない	22 (0.5%)	14 (0.7%)	8 (0.4%)
5 重要でない	24 (0.6%)	16 (0.8%)	8 (0.4%)
6 無回答	797 (19.6%)	379 (19.1%)	418 (20.1%)
合 計	4,066	1,988	2,078

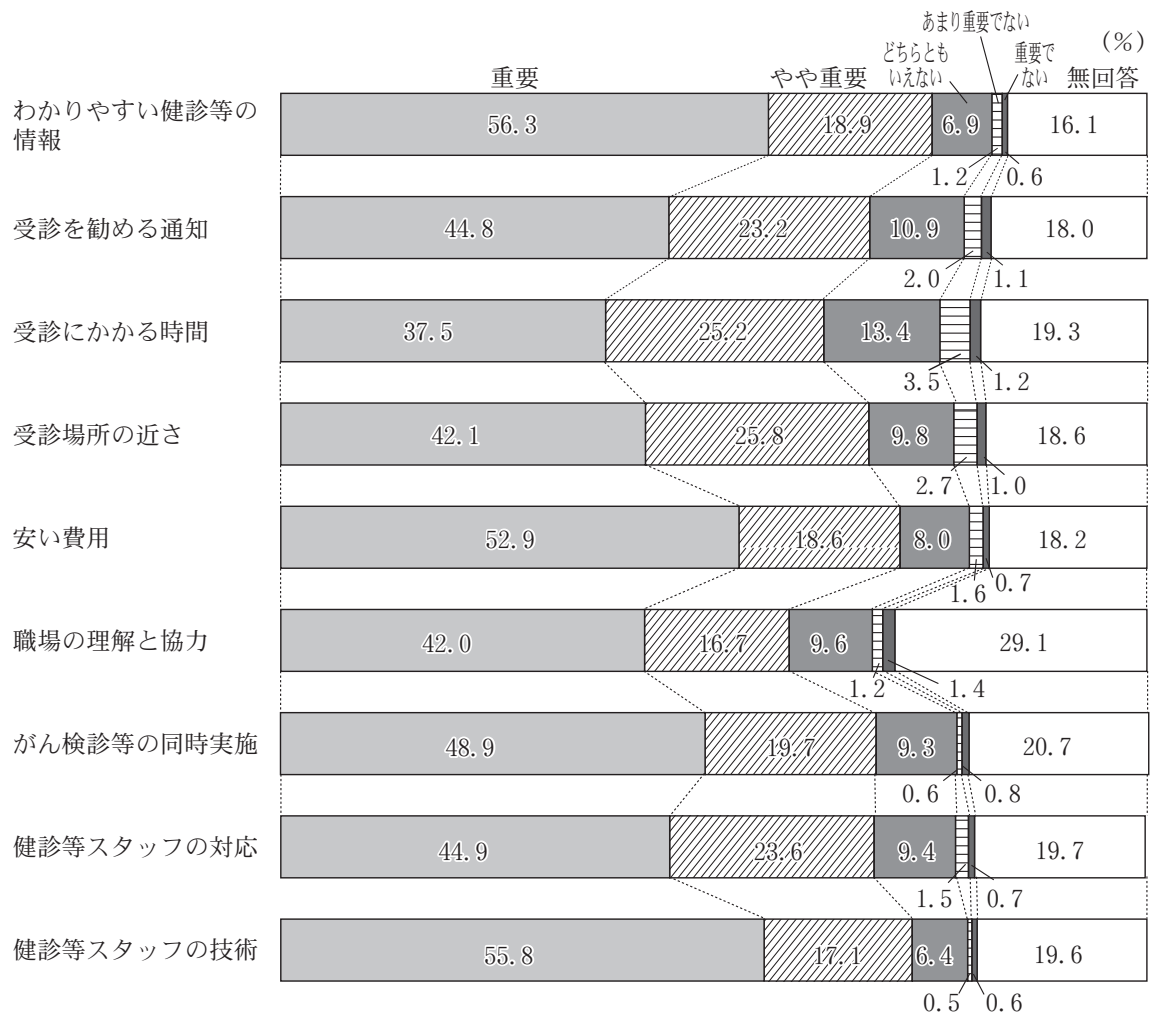

23 睡眠時間の状況 (満15歳以上対象) (調査票 問23の集計結果)

あなたは、ふだんの睡眠時間は、どのくらいですか。				
	全体	男性	女性	
1 4時間以下	95 (2.3%)	37 (1.9%)	58 (2.8%)	
2 5時間位	723 (17.8%)	344 (17.3%)	379 (18.2%)	
3 6時間位	1,372 (33.7%)	665 (33.5%)	707 (34.0%)	
4 7時間位	1,058 (26.0%)	513 (25.8%)	545 (26.2%)	
5 8時間位	567 (13.9%)	306 (15.4%)	261 (12.6%)	
6 9時間以上	115 (2.8%)	56 (2.8%)	59 (2.8%)	
7 無回答	136 (3.3%)	67 (3.4%)	69 (3.3%)	
合計	4,066	1,988	2,078	

【平成21年度県民健康調査】

	全 体	男 性	女 性
1 4時間以下	65 (1.4%)	31 (1.4%)	34 (1.4%)
2 5時間位	461 (10.0%)	220 (9.7%)	241 (10.2%)
3 6時間位	1,378 (29.8%)	648 (28.7%)	730 (30.8%)
4 7時間位	1,390 (30.0%)	674 (29.8%)	716 (30.2%)
5 8時間位	1,005 (21.7%)	522 (23.1%)	483 (20.4%)
6 9時間以上	255 (5.5%)	136 (6.0%)	119 (5.0%)
7 無回答	74 (1.6%)	28 (1.2%)	46 (1.9%)
合 計	4,628	2,259	2,369

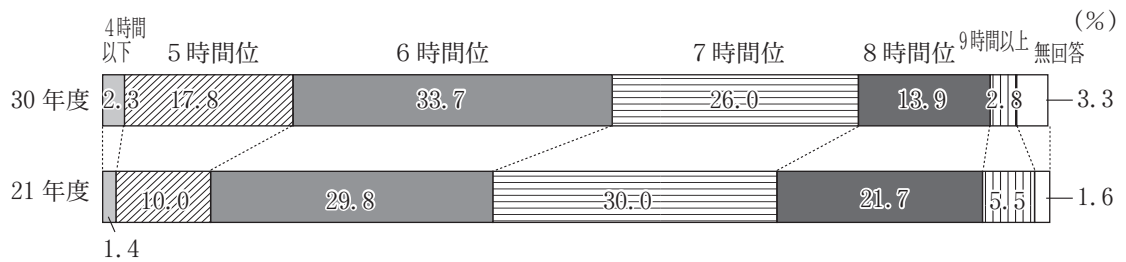

*40～69歳

	全 体	男 性	女 性
1 6時間以下	1,197 (59.5%)	543 (56.2%)	654 (62.6%)
2 7時間以上	760 (37.8%)	398 (41.2%)	362 (34.6%)
3 無回答	55 (2.7%)	26 (2.7%)	29 (2.8%)
合 計	2,012	967	1,045



24 疲労の状況（満15歳以上対象）（調査票 問24の集計結果）

疲れすぎたと感じていますか。

	全 体	男 性	女 性
1 感じている	1,770 (43.5%)	827 (41.6%)	943 (45.4%)
2 あまり感じていない	1,959 (48.2%)	981 (49.3%)	978 (47.1%)
3 まったく感じていない	168 (4.1%)	101 (5.1%)	67 (3.2%)
4 無回答	169 (4.2%)	79 (4.0%)	90 (4.3%)
合 計	4,066	1,988	2,078

【平成21年度県民健康調査】

	全 体	男 性	女 性
1 感じている	1,771 (38.3%)	831 (36.8%)	940 (39.7%)
2 あまり感じていない	2,503 (54.1%)	1,251 (55.4%)	1,252 (52.8%)
3 まったく感じていない	254 (5.5%)	138 (6.1%)	116 (4.9%)
4 無回答	100 (2.2%)	39 (1.7%)	61 (2.6%)
合 計	4,628	2,259	2,369

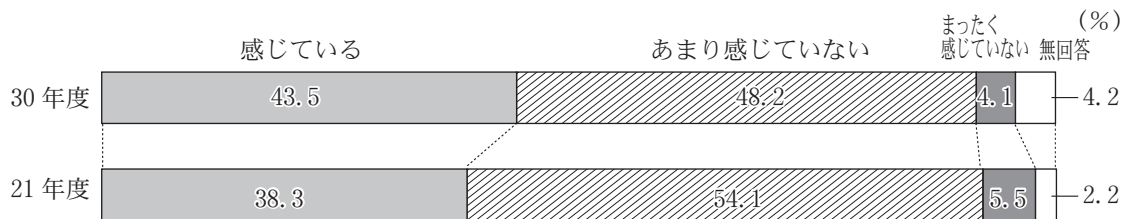

*40～69歳

	全 体	男 性	女 性
1 感じている	958 (47.6%)	449 (46.4%)	509 (48.7%)
2 あまり感じていない	923 (45.9%)	448 (46.3%)	475 (45.5%)
3 まったく感じていない	61 (3.0%)	34 (3.5%)	27 (2.6%)
無回答	70 (3.5%)	36 (3.7%)	34 (3.3%)
合 計	2,012	967	1,045



1 健康についての意識（満15歳以上対象）（調査票 問1）

問1 あなたはふだん自分で健康だと思えますか。あてはまるものを1つだけ選んで○をつけてください。

- 1 非常に健康だと思う 2 まあ健康な方だと思う
3 あまり健康ではない 4 健康ではない

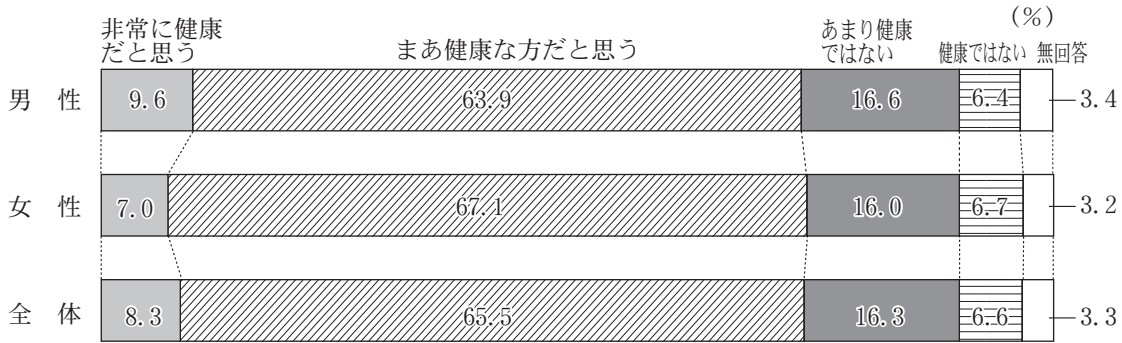

	10	割合	20	割合	30	割合	40	割合	50	割合	64	割合	69	割合	70	割合	80	割合	90	割合	全体数	割合
1と回答																						
男性	34	44.7%	31	25.8%	29	14.1%	18	7.1%	17	6.3%	8	4.1%	12	4.9%	25	6.3%	15	7.4%	2	11.1%	191	9.6%
女性	19	27.9%	12	9.8%	22	12.7%	23	9.0%	20	6.0%	12	5.9%	10	3.9%	17	4.6%	8	3.2%	2	3.8%	145	7.0%
男女合計	53	36.8%	43	17.8%	51	13.5%	41	8.1%	37	6.1%	20	5.0%	22	4.4%	42	5.5%	23	5.1%	4	5.6%	336	8.3%
2と回答																						
男性	37	48.7%	69	57.5%	120	58.3%	183	72.3%	182	66.9%	136	69.0%	172	70.2%	264	66.3%	98	48.3%	10	55.6%	1271	63.9%
女性	39	57.4%	86	70.5%	120	69.4%	176	68.8%	238	71.9%	150	73.9%	181	71.0%	254	69.0%	121	48.6%	29	54.7%	1394	67.1%
男女合計	76	52.8%	155	64.0%	240	63.3%	359	70.5%	420	69.7%	286	71.5%	353	70.6%	518	67.6%	219	48.5%	39	54.9%	2665	65.5%
3と回答																						
男性	3	3.9%	14	11.7%	41	19.9%	37	14.6%	52	19.1%	40	20.3%	33	13.5%	59	14.8%	49	24.1%	3	16.7%	331	16.6%
女性	6	8.8%	15	12.3%	25	14.5%	41	16.0%	45	13.6%	35	17.2%	42	16.5%	59	16.0%	60	24.1%	5	9.4%	333	16.0%
男女合計	9	6.3%	29	12.0%	66	17.4%	78	15.3%	97	16.1%	75	18.8%	75	15.0%	118	15.4%	109	24.1%	8	11.3%	664	16.3%
4と回答																						
男性	0	0.0%	3	2.5%	10	4.9%	5	2.0%	15	5.5%	8	4.1%	19	7.8%	36	9.0%	30	14.8%	2	11.1%	128	6.4%
女性	1	1.5%	3	2.5%	4	2.3%	10	3.9%	18	5.4%	1	0.5%	15	5.9%	30	8.2%	46	18.5%	11	20.8%	139	6.7%
男女合計	1	0.7%	6	2.5%	14	3.7%	15	2.9%	33	5.5%	9	2.3%	34	6.8%	66	8.6%	76	16.8%	13	18.3%	267	6.6%
無回答																						
男性	2	2.6%	3	2.5%	6	2.9%	10	4.0%	6	2.2%	5	2.5%	9	3.7%	14	3.5%	11	5.4%	1	5.6%	67	3.4%
女性	3	4.4%	6	4.9%	2	1.2%	6	2.3%	10	3.0%	5	2.5%	7	2.7%	8	2.2%	14	5.6%	6	11.3%	67	3.2%
男女合計	5	3.5%	9	3.7%	8	2.1%	16	3.1%	16	2.7%	10	2.5%	16	3.2%	22	2.9%	25	5.5%	7	9.9%	134	3.3%
全体(人)																						
男性	76		120		206		253		272		197		245		398		203		18		1988	
女性	68		122		173		256		331		203		255		368		249		53		2078	
男女合計	144		242		379		509		603		400		500		766		452		71		4066	

県 北

	10	割合	20	割合	30	割合	40	割合	50	割合	64	割合	69	割合	70～	割合	全体数	割合
1と回答																		
男性	14	48.3%	8	21.1%	9	15.5%	6	8.5%	7	8.9%	2	3.6%	3	4.7%	11	6.5%	60	10.6%
女性	6	26.1%	8	17.8%	7	15.6%	9	13.2%	5	5.0%	4	8.0%	2	3.0%	7	3.9%	48	8.3%
男女合計	20	38.5%	16	19.3%	16	15.5%	15	10.8%	12	6.7%	6	5.7%	5	3.8%	18	5.1%	108	9.4%
2と回答																		
男性	12	41.4%	21	55.3%	32	55.2%	53	74.6%	52	65.8%	41	73.2%	42	65.6%	107	62.9%	360	63.7%
女性	11	47.8%	26	57.8%	28	62.2%	47	69.1%	74	74.0%	37	74.0%	45	68.2%	104	57.5%	372	64.4%
男女合計	23	44.2%	47	56.6%	60	58.3%	100	71.9%	126	70.4%	78	73.6%	87	66.9%	211	60.1%	732	64.0%
3と回答																		
男性	1	3.4%	6	15.8%	10	17.2%	7	9.9%	13	16.5%	11	19.6%	9	14.1%	34	20.0%	91	16.1%
女性	3	13.0%	7	15.6%	5	11.1%	7	10.3%	15	15.0%	8	16.0%	9	13.6%	39	21.5%	93	16.1%
男女合計	4	7.7%	13	15.7%	15	14.6%	14	10.1%	28	15.6%	19	17.9%	18	13.8%	73	20.8%	184	16.1%
4と回答																		
男性	0	0.0%	1	2.6%	5	8.6%	1	1.4%	5	6.3%	1	1.8%	8	12.5%	11	6.5%	32	5.7%
女性	1	4.3%	2	4.4%	3	6.7%	2	2.9%	3	3.0%	0	0.0%	6	9.1%	22	12.2%	39	6.7%
男女合計	1	1.9%	3	3.6%	8	7.8%	3	2.2%	8	4.5%	1	0.9%	14	10.8%	33	9.4%	71	6.2%
無回答																		
男性	2	6.9%	2	5.3%	2	3.4%	4	5.6%	2	2.5%	1	1.8%	2	3.1%	7	4.1%	22	3.9%
女性	2	8.7%	2	4.4%	2	4.4%	3	4.4%	3	3.0%	1	2.0%	4	6.1%	9	5.0%	26	4.5%
男女合計	4	7.7%	4	4.8%	4	3.9%	7	5.0%	5	2.8%	2	1.9%	6	4.6%	16	4.6%	48	4.2%
全体(人)																		
男性	29		38		58		71		79		56		64		170		565	
女性	23		45		45		68		100		50		66		181		578	
男女合計	52		83		103		139		179		106		130		351		1143	

県 中

	10	割合	20	割合	30	割合	40	割合	50	割合	64	割合	69	割合	70～	割合	全体数	割合
1と回答																		
男性	6	37.5%	6	25.0%	10	18.5%	3	4.2%	3	4.4%	2	4.5%	2	3.5%	10	9.1%	42	9.5%
女性	6	28.6%	0	0.0%	6	12.8%	6	8.6%	6	7.1%	3	6.4%	3	4.5%	4	3.8%	34	7.2%
男女合計	12	32.4%	6	10.7%	16	15.8%	9	6.4%	9	5.9%	5	5.5%	5	4.1%	14	6.5%	76	8.3%
2と回答																		
男性	10	62.5%	15	62.5%	37	68.5%	60	84.5%	50	73.5%	31	70.5%	41	71.9%	63	57.3%	307	69.1%
女性	13	61.9%	28	87.5%	34	72.3%	48	68.6%	58	68.2%	35	74.5%	46	69.7%	59	55.7%	321	67.7%
男女合計	23	62.2%	43	76.8%	71	70.3%	108	76.6%	108	70.6%	66	72.5%	87	70.7%	122	56.5%	628	68.4%
3と回答																		
男性	0	0.0%	3	12.5%	5	9.3%	5	7.0%	10	14.7%	6	13.6%	5	8.8%	20	18.2%	54	12.2%
女性	2	9.5%	2	6.3%	6	12.8%	13	18.6%	11	12.9%	8	17.0%	12	18.2%	21	19.8%	75	15.8%
男女合計	2	5.4%	5	8.9%	11	10.9%	18	12.8%	21	13.7%	14	15.4%	17	13.8%	41	19.0%	129	14.1%
4と回答																		
男性	0	0.0%	0	0.0%	2	3.7%	2	2.8%	3	4.4%	2	4.5%	5	8.8%	13	11.8%	27	6.1%
女性	0	0.0%	1	3.1%	1	2.1%	3	4.3%	8	9.4%	1	2.1%	4	6.1%	17	16.0%	35	7.4%
男女合計	0	0.0%	1	1.8%	3	3.0%	5	3.5%	11	7.2%	3	3.3%	9	7.3%	30	13.9%	62	6.8%
無回答																		
男性	0	0.0%	0	0.0%	0	0.0%	1	1.4%	2	2.9%	3	6.8%	4	7.0%	4	3.6%	14	3.2%
女性	0	0.0%	1	3.1%	0	0.0%	0	0.0%	2	2.4%	0	0.0%	1	1.5%	5	4.7%	9	1.9%
男女合計	0	0.0%	1	1.8%	0	0.0%	1	0.7%	4	2.6%	3	3.3%	5	4.1%	9	4.2%	23	2.5%
全体(人)																		
男性	16		24		54		71		68		44		57		110		444	
女性	21		32		47		70		85		47		66		106		474	
男女合計	37		56		101		141		153		91		123		216		918	

県 南

	10	割合	20	割合	30	割合	40	割合	50	割合	64	割合	69	割合	70～	割合	全体数	割合
1と回答																		
男性	0	0.0%	4	30.8%	2	16.7%	0	0.0%	2	6.9%	2	9.5%	5	20.0%	5	8.1%	20	10.9%
女性	2	50.0%	0	0.0%	0	0.0%	1	4.8%	2	7.1%	1	4.0%	0	0.0%	4	5.8%	10	5.3%
男女合計	2	40.0%	4	23.5%	2	9.1%	1	2.4%	4	7.0%	3	6.5%	5	9.8%	9	6.9%	30	8.1%
2と回答																		
男性	1	100.0%	8	61.5%	4	33.3%	12	57.1%	19	65.5%	15	71.4%	16	64.0%	40	64.5%	115	62.5%
女性	2	50.0%	3	75.0%	9	90.0%	16	76.2%	20	71.4%	18	72.0%	19	73.1%	48	69.6%	135	72.2%
男女合計	3	60.0%	11	64.7%	13	59.1%	28	66.7%	39	68.4%	33	71.7%	35	68.6%	88	67.2%	250	67.4%
3と回答																		
男性	0	0.0%	1	7.7%	5	41.7%	9	42.9%	5	17.2%	3	14.3%	3	12.0%	7	11.3%	33	17.9%
女性	0	0.0%	1	25.0%	1	10.0%	2	9.5%	4	14.3%	4	16.0%	6	23.1%	10	14.5%	28	15.0%
男女合計	0	0.0%	2	11.8%	6	27.3%	11	26.2%	9	15.8%	7	15.2%	9	17.6%	17	13.0%	61	16.4%
4と回答																		
男性	0	0.0%	0	0.0%	0	0.0%	0	0.0%	3	10.3%	1	4.8%	0	0.0%	9	14.5%	13	7.1%
女性	0	0.0%	0	0.0%	0	0.0%	2	9.5%	0	0.0%	0	0.0%	1	3.8%	5	7.2%	8	4.3%
男女合計	0	0.0%	0	0.0%	0	0.0%	2	4.8%	3	5.3%	1	2.2%	1	2.0%	14	10.7%	21	5.7%
無回答																		
男性	0	0.0%	0	0.0%	1	8.3%	0	0.0%	0	0.0%	0	0.0%	1	4.0%	1	1.6%	3	1.6%
女性	0	0.0%	0	0.0%	0	0.0%	0	0.0%	2	7.1%	2	8.0%	0	0.0%	2	2.9%	6	3.2%
男女合計	0	0.0%	0	0.0%	1	4.5%	0	0.0%	2	3.5%	2	4.3%	1	2.0%	3	2.3%	9	2.4%
全体(人)																		
男性	1		13		12		21		29		21		25		62		184	
女性	4		4		10		21		28		25		26		69		187	
男女合計	5		17		22		42		57		46		51		131		371	

会 津

	10	割合	20	割合	30	割合	40	割合	50	割合	64	割合	69	割合	70～	割合	全体数	割合
1と回答																		
男性	5	41.7%	2	15.4%	1	5.0%	2	8.0%	1	3.1%	1	2.9%	1	3.0%	6	5.0%	19	6.6%
女性	2	40.0%	1	7.1%	2	9.1%	3	11.1%	1	2.7%	1	3.1%	3	9.4%	6	4.6%	19	6.4%
男女合計	7	41.2%	3	11.1%	3	7.1%	5	9.6%	2	2.9%	2	3.0%	4	6.2%	12	4.8%	38	6.5%
2と回答																		
男性	6	50.0%	8	61.5%	13	65.0%	15	60.0%	25	78.1%	25	71.4%	25	75.8%	73	61.3%	190	65.7%
女性	3	60.0%	10	71.4%	13	59.1%	19	70.4%	29	78.4%	25	78.1%	23	71.9%	75	57.7%	197	65.9%
男女合計	9	52.9%	18	66.7%	26	61.9%	34	65.4%	54	78.3%	50	74.6%	48	73.8%	148	59.4%	387	65.8%
3と回答																		
男性	1	8.3%	2	15.4%	3	15.0%	4	16.0%	2	6.3%	7	20.0%	4	12.1%	17	14.3%	40	13.8%
女性	0	0.0%	2	14.3%	7	31.8%	4	14.8%	4	10.8%	5	15.6%	4	12.5%	24	18.5%	50	16.7%
男女合計	1	5.9%	4	14.8%	10	23.8%	8	15.4%	6	8.7%	12	17.9%	8	12.3%	41	16.5%	90	15.3%
4と回答																		
男性	0	0.0%	1	7.7%	1	5.0%	2	8.0%	3	9.4%	1	2.9%	2	6.1%	17	14.3%	27	9.3%
女性	0	0.0%	0	0.0%	0	0.0%	0	0.0%	1	2.7%	0	0.0%	1	3.1%	19	14.6%	21	7.0%
男女合計	0	0.0%	1	3.7%	1	2.4%	2	3.8%	4	5.8%	1	1.5%	3	4.6%	36	14.5%	48	8.2%
無回答																		
男性	0	0.0%	0	0.0%	2	10.0%	2	8.0%	1	3.1%	1	2.9%	1	3.0%	6	5.0%	13	4.5%
女性	0	0.0%	1	7.1%	0	0.0%	1	3.7%	2	5.4%	1	3.1%	1	3.1%	6	4.6%	12	4.0%
男女合計	0	0.0%	1	3.7%	2	4.8%	3	5.8%	3	4.3%	2	3.0%	2	3.1%	12	4.8%	25	4.3%
全体(人)																		
男性	12		13		20		25		32		35		33		119		289	
女性	5		14		22		27		37		32		32		130		299	
男女合計	17		27		42		52		69		67		65		249		588	

南 会 津

	10	割合	20	割合	30	割合	40	割合	50	割合	64	割合	69	割合	70～	割合	全体数	割合
1と回答																		
男性	0	0.0%	1	50.0%	0	0.0%	0	0.0%	0	0.0%	0	0.0%	0	0.0%	1	5.0%	2	5.3%
女性	0	0.0%	0	0.0%	0	0.0%	0	0.0%	0	0.0%	0	0.0%	0	0.0%	0	0.0%	0	0.0%
男女合計	0	0.0%	1	50.0%	0	0.0%	0	0.0%	0	0.0%	0	0.0%	0	0.0%	1	2.9%	2	2.7%
2と回答																		
男性	1	50.0%	0	0.0%	1	100.0%	2	66.7%	2	66.7%	2	66.7%	2	50.0%	11	55.0%	21	55.3%
女性	3	100.0%	0	0.0%	1	100.0%	3	60.0%	3	100.0%	1	50.0%	5	83.3%	9	60.0%	25	71.4%
男女合計	4	80.0%	0	0.0%	2	100.0%	5	62.5%	5	83.3%	3	60.0%	7	70.0%	20	57.1%	46	63.0%
3と回答																		
男性	1	50.0%	1	50.0%	0	0.0%	1	33.3%	1	33.3%	1	33.3%	2	50.0%	6	30.0%	13	34.2%
女性	0	0.0%	0	0.0%	0	0.0%	2	40.0%	0	0.0%	1	50.0%	1	16.7%	3	20.0%	7	20.0%
男女合計	1	20.0%	1	50.0%	0	0.0%	3	37.5%	1	16.7%	2	40.0%	3	30.0%	9	25.7%	20	27.4%
4と回答																		
男性	0	0.0%	0	0.0%	0	0.0%	0	0.0%	0	0.0%	0	0.0%	0	0.0%	2	10.0%	2	5.3%
女性	0	0.0%	0	0.0%	0	0.0%	0	0.0%	0	0.0%	0	0.0%	0	0.0%	3	20.0%	3	8.6%
男女合計	0	0.0%	0	0.0%	0	0.0%	0	0.0%	0	0.0%	0	0.0%	0	0.0%	5	14.3%	5	6.8%
無回答																		
男性	0	0.0%	0	0.0%	0	0.0%	0	0.0%	0	0.0%	0	0.0%	0	0.0%	0	0.0%	0	0.0%
女性	0	0.0%	0	0.0%	0	0.0%	0	0.0%	0	0.0%	0	0.0%	0	0.0%	0	0.0%	0	0.0%
男女合計	0	0.0%	0	0.0%	0	0.0%	0	0.0%	0	0.0%	0	0.0%	0	0.0%	0	0.0%	0	0.0%
全体(人)																		
男性	2		2		1		3		3		3		4		20		38	
女性	3		0		1		5		3		2		6		15		35	
男女合計	5		2		2		8		6		5		10		35		73	

相 双

	10	割合	20	割合	30	割合	40	割合	50	割合	64	割合	69	割合	70～	割合	全体数	割合
1と回答																		
男性	2	50.0%	1	11.1%	2	20.0%	0	0.0%	0	0.0%	0	0.0%	0	0.0%	1	2.6%	6	5.0%
女性	1	100.0%	0	0.0%	2	25.0%	0	0.0%	0	0.0%	0	0.0%	1	4.3%	2	4.2%	6	4.5%
男女合計	3	60.0%	1	7.1%	4	22.2%	0	0.0%	0	0.0%	0	0.0%	1	2.1%	3	3.4%	12	4.8%
2と回答																		
男性	2	50.0%	7	77.8%	5	50.0%	5	62.5%	6	50.0%	9	69.2%	16	64.0%	23	59.0%	73	60.8%
女性	0	0.0%	4	80.0%	6	75.0%	5	45.5%	14	66.7%	13	86.7%	16	69.6%	34	70.8%	92	69.7%
男女合計	2	40.0%	11	78.6%	11	61.1%	10	52.6%	20	60.6%	22	78.6%	32	66.7%	57	65.5%	165	65.5%
3と回答																		
男性	0	0.0%	1	11.1%	2	20.0%	1	12.5%	6	50.0%	4	30.8%	6	24.0%	10	25.6%	30	25.0%
女性	0	0.0%	1	20.0%	0	0.0%	3	27.3%	5	23.8%	2	13.3%	6	26.1%	8	16.7%	25	18.9%
男女合計	0	0.0%	2	14.3%	2	11.1%	4	21.1%	11	33.3%	6	21.4%	12	25.0%	18	20.7%	55	21.8%
4と回答																		
男性	0	0.0%	0	0.0%	1	10.0%	0	0.0%	0	0.0%	0	0.0%	2	8.0%	5	12.8%	8	6.7%
女性	0	0.0%	0	0.0%	0	0.0%	2	18.2%	2	9.5%	0	0.0%	0	0.0%	4	8.3%	8	6.1%
男女合計	0	0.0%	0	0.0%	1	5.6%	2	10.5%	2	6.1%	0	0.0%	2	4.2%	9	10.3%	16	6.3%
無回答																		
男性	0	0.0%	0	0.0%	0	0.0%	2	25.0%	0	0.0%	0	0.0%	1	4.0%	0	0.0%	3	2.5%
女性	0	0.0%	0	0.0%	0	0.0%	1	9.1%	0	0.0%	0	0.0%	0	0.0%	0	0.0%	1	0.8%
男女合計	0	0.0%	0	0.0%	0	0.0%	3	15.8%	0	0.0%	0	0.0%	1	2.1%	0	0.0%	4	1.6%
全体(人)																		
男性	4		9		10		8		12		13		25		39		120	
女性	1		5		8		11		21		15		23		48		132	
男女合計	5		14		18		19		33		28		48		87		252	

いわき

	10	割合	20	割合	30	割合	40	割合	50	割合	64	割合	69	割合	70～	割合	全体数	割合
1と回答																		
男性	7	58.3%	9	42.9%	5	9.8%	7	13.0%	4	8.2%	1	4.0%	1	2.7%	8	8.1%	42	12.1%
女性	2	18.2%	3	13.6%	5	12.5%	4	7.4%	6	10.5%	3	9.4%	1	2.8%	4	3.3%	28	7.5%
男女合計	9	39.1%	12	27.9%	10	11.0%	11	10.2%	10	9.4%	4	7.0%	2	2.7%	12	5.5%	70	9.7%
2と回答																		
男性	5	41.7%	10	47.6%	28	54.9%	36	66.7%	28	57.1%	13	52.0%	30	81.1%	55	55.6%	205	58.9%
女性	7	63.6%	15	68.2%	29	72.5%	38	70.4%	40	70.2%	21	65.6%	27	75.0%	75	62.0%	252	67.6%
男女合計	12	52.2%	25	58.1%	57	62.6%	74	68.5%	68	64.2%	34	59.6%	57	78.1%	130	59.1%	457	63.4%
3と回答																		
男性	0	0.0%	0	0.0%	16	31.4%	10	18.5%	15	30.6%	8	32.0%	4	10.8%	17	17.2%	70	20.1%
女性	1	9.1%	2	9.1%	6	15.0%	10	18.5%	6	10.5%	7	21.9%	4	11.1%	19	15.7%	55	14.7%
男女合計	1	4.3%	2	4.7%	22	24.2%	20	18.5%	21	19.8%	15	26.3%	8	11.0%	36	16.4%	125	17.3%
4と回答																		
男性	0	0.0%	1	4.8%	1	2.0%	0	0.0%	1	2.0%	3	12.0%	2	5.4%	11	11.1%	19	5.5%
女性	0	0.0%	0	0.0%	0	0.0%	1	1.9%	4	7.0%	0	0.0%	3	8.3%	17	14.0%	25	6.7%
男女合計	0	0.0%	1	2.3%	1	1.1%	1	0.9%	5	4.7%	3	5.3%	5	6.8%	28	12.7%	44	6.1%
無回答																		
男性	0	0.0%	1	4.8%	1	2.0%	1	1.9%	1	2.0%	0	0.0%	0	0.0%	8	8.1%	12	3.4%
女性	1	9.1%	2	9.1%	0	0.0%	1	1.9%	1	1.8%	1	3.1%	1	2.8%	6	5.0%	13	3.5%
男女合計	1	4.3%	3	7.0%	1	1.1%	2	1.9%	2	1.9%	1	1.8%	1	1.4%	14	6.4%	25	3.5%
全体(人)																		
男性	12		21		51		54		49		25		37		99		348	
女性	11		22		40		54		57		32		36		121		373	
男女合計	23		43		91		108		106		57		73		220		721	

全県(60歳以上・再掲)

	64	割合	69	割合	70	割合	80	割合	90	割合	全体数	割合
1と回答												
男性	8	4.1%	12	4.9%	25	6.3%	15	7.4%	2	11.1%	62	5.8%
女性	12	5.9%	10	3.9%	17	4.6%	8	3.2%	2	3.8%	49	4.3%
男女合計	20	5.0%	22	4.4%	42	5.5%	23	5.1%	4	5.6%	111	5.1%
2と回答												
男性	136	69.0%	172	70.2%	264	66.3%	98	48.3%	10	55.6%	680	64.1%
女性	150	73.9%	181	71.0%	254	69.0%	121	48.6%	29	54.7%	735	65.2%
男女合計	286	71.5%	353	70.6%	518	67.6%	219	48.5%	39	54.9%	1415	64.6%
3と回答												
男性	40	20.3%	33	13.5%	59	14.8%	49	24.1%	3	16.7%	184	17.3%
女性	35	17.2%	42	16.5%	59	16.0%	60	24.1%	5	9.4%	201	17.8%
男女合計	75	18.8%	75	15.0%	118	15.4%	109	24.1%	8	11.3%	385	17.6%
4と回答												
男性	8	4.1%	19	7.8%	36	9.0%	30	14.8%	2	11.1%	95	9.0%
女性	1	0.5%	15	5.9%	30	8.2%	46	18.5%	11	20.8%	103	9.1%
男女合計	9	2.3%	34	6.8%	66	8.6%	76	16.8%	13	18.3%	198	9.0%
無回答												
男性	5	2.5%	9	3.7%	14	3.5%	11	5.4%	1	5.6%	40	3.8%
女性	5	2.5%	7	2.7%	8	2.2%	14	5.6%	6	11.3%	40	3.5%
男女合計	10	2.5%	16	3.2%	22	2.9%	25	5.5%	7	9.9%	80	3.7%
全体(人)												
男性	197		245		398		203		18		1061	
女性	203		255		368		249		53		1128	
男女合計	400		500		766		452		71		2189	

2 健康づくりのために気をつけていること（満15歳以上対象）（調査票 問2）

問2 あなたは健康づくりのためにどのようなことに気をつけていますか。あてはまる番号に○をつけてください。（○はいくつでも）

- 1 食生活に気をつけている
- 2 歩いたり軽い体操をしている
- 3 スポーツやランニングをしている
- 4 休養や睡眠を十分とるようにしている
- 5 酒を控えるようにしている
- 6 たばこを吸わないようにしている
- 7 定期的に健康診断を受けるようにしている
- 8 趣味や生きがいをもち、生活にメリハリを持たせるようにしている
- 9 健康補助食品などを利用している
- 10 その他
- 11 特に何もしていない

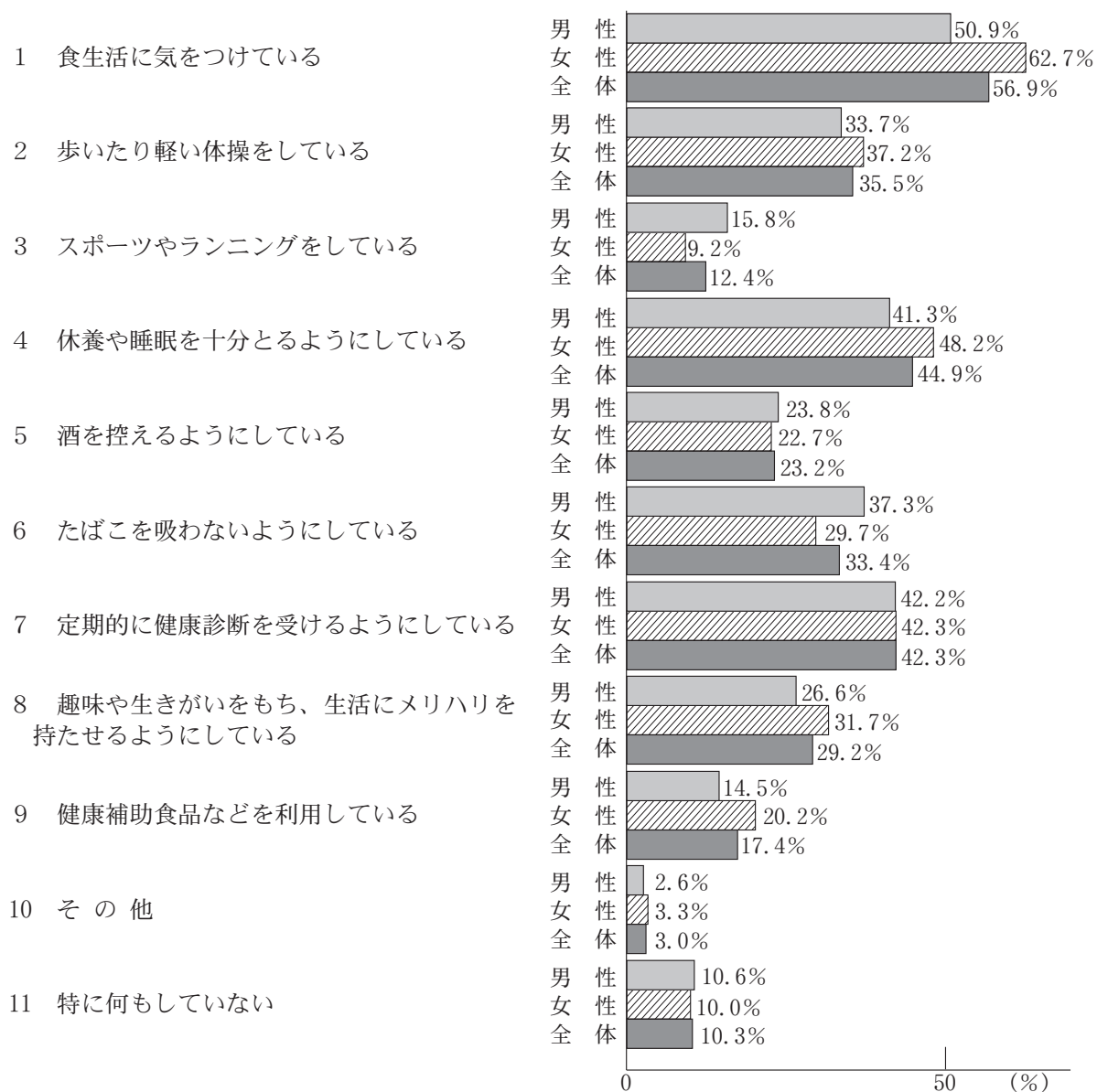

1. 食生活に気をつけていると回答した人

	10	割合	20	割合	30	割合	40	割合	50	割合	64	割合	69	割合	70	割合	80	割合	90	割合	全体数	割合
1に○																						
男性	21	27.6%	27	22.5%	74	35.9%	88	34.8%	133	48.9%	111	56.3%	155	63.3%	255	64.1%	138	68.0%	10	55.6%	1012	50.9%
女性	24	35.3%	51	41.8%	81	46.8%	126	49.2%	214	64.7%	143	70.4%	192	75.3%	286	77.7%	160	64.3%	25	47.2%	1302	62.7%
男女合計	45	31.3%	78	32.2%	155	40.9%	214	42.0%	347	57.5%	254	63.5%	347	69.4%	541	70.6%	298	65.9%	35	49.3%	2314	56.9%
全体(人)																						
男性	76		120		206		253		272		197		245		398		203		18		1988	
女性	68		122		173		256		331		203		255		368		249		53		2078	
男女合計	144		242		379		509		603		400		500		766		452		71		4066	

2. 歩いたり軽い体操をしていると回答した人

	10	割合	20	割合	30	割合	40	割合	50	割合	64	割合	69	割合	70	割合	80	割合	90	割合	全体数	割合
2に○																						
男性	17	22.4%	20	16.7%	40	19.4%	39	15.4%	72	26.5%	69	35.0%	109	44.5%	203	51.0%	94	46.3%	6	33.3%	669	33.7%
女性	13	19.1%	25	20.5%	39	22.5%	62	24.2%	103	31.1%	76	37.4%	128	50.2%	212	57.6%	96	38.6%	19	35.8%	773	37.2%
男女合計	30	20.8%	45	18.6%	79	20.8%	101	19.8%	175	29.0%	145	36.3%	237	47.4%	415	54.2%	190	42.0%	25	35.2%	1442	35.5%
全体(人)																						
男性	76		120		206		253		272		197		245		398		203		18		1988	
女性	68		122		173		256		331		203		255		368		249		53		2078	
男女合計	144		242		379		509		603		400		500		766		452		71		4066	

3. スポーツやランニングをしていると回答した人

	10	割合	20	割合	30	割合	40	割合	50	割合	64	割合	69	割合	70	割合	80	割合	90	割合	全体数	割合
3に○																						
男性	32	42.1%	33	27.5%	42	20.4%	39	15.4%	36	13.2%	29	14.7%	34	13.9%	51	12.8%	19	9.4%	0	0.0%	315	15.8%
女性	8	11.8%	12	9.8%	10	5.8%	14	5.5%	29	8.8%	20	9.9%	28	11.0%	49	13.3%	19	7.6%	2	3.8%	191	9.2%
男女合計	40	27.8%	45	18.6%	52	13.7%	53	10.4%	65	10.8%	49	12.3%	62	12.4%	100	13.1%	38	8.4%	2	2.8%	506	12.4%
全体(人)																						
男性	76		120		206		253		272		197		245		398		203		18		1988	
女性	68		122		173		256		331		203		255		368		249		53		2078	
男女合計	144		242		379		509		603		400		500		766		452		71		4066	

4. 休養や睡眠を十分とるようにしていると回答した人

	10	割合	20	割合	30	割合	40	割合	50	割合	64	割合	69	割合	70	割合	80	割合	90	割合	全体数	割合
4に○																						
男性	31	40.8%	38	31.7%	65	31.6%	68	26.9%	97	35.7%	77	39.1%	120	49.0%	204	51.3%	112	55.2%	10	55.6%	822	41.3%
女性	28	41.2%	56	45.9%	80	46.2%	100	39.1%	152	45.9%	95	46.8%	132	51.8%	206	56.0%	133	53.4%	20	37.7%	1002	48.2%
男女合計	59	41.0%	94	38.8%	145	38.3%	168	33.0%	249	41.3%	172	43.0%	252	50.4%	410	53.5%	245	54.2%	30	42.3%	1824	44.9%
全体(人)																						
男性	76		120		206		253		272		197		245		398		203		18		1988	
女性	68		122		173		256		331		203		255		368		249		53		2078	
男女合計	144		242		379		509		603		400		500		766		452		71		4066	

5. 酒を控えるようにしていると回答した人

	10	割合	20	割合	30	割合	40	割合	50	割合	64	割合	69	割合	70	割合	80	割合	90	割合	全体数	割合
5に○																						
男性	8	10.5%	32	26.7%	48	23.3%	33	13.0%	52	19.1%	47	23.9%	56	22.9%	136	34.2%	57	28.1%	4	22.2%	473	23.8%
女性	6	8.8%	23	18.9%	46	26.6%	60	23.4%	84	25.4%	56	27.6%	62	24.3%	83	22.6%	45	18.1%	6	11.3%	471	22.7%
男女合計	14	9.7%	55	22.7%	94	24.8%	93	18.3%	136	22.6%	103	25.8%	118	23.6%	219	28.6%	102	22.6%	10	14.1%	944	23.2%
全体(人)																						
男性	76		120		206		253		272		197		245		398		203		18		1988	
女性	68		122		173		256		331		203		255		368		249		53		2078	
男女合計	144		242		379		509		603		400		500		766		452		71		4066	

6. たばこを吸わないようにしていると回答した人

	10	割合	20	割合	30	割合	40	割合	50	割合	64	割合	69	割合	70	割合	80	割合	90	割合	全体数	割合
6に○																						
男性	7	9.2%	46	38.3%	74	35.9%	82	32.4%	91	33.5%	82	41.6%	105	42.9%	181	45.5%	70	34.5%	3	16.7%	741	37.3%
女性	8	11.8%	46	37.7%	67	38.7%	98	38.3%	109	32.9%	65	32.0%	83	32.5%	88	23.9%	48	19.3%	5	9.4%	617	29.7%
男女合計	15	10.4%	92	38.0%	141	37.2%	180	35.4%	200	33.2%	147	36.8%	188	37.6%	269	35.1%	118	26.1%	8	11.3%	1358	33.4%
全体(人)																						
男性	76		120		206		253		272		197		245		398		203		18		1988	
女性	68		122		173		256		331		203		255		368		249		53		2078	
男女合計	144		242		379		509		603		400		500		766		452		71		4066	

7. 定期的に健康診断を受けるようにしていると回答した人

	10	割合	20	割合	30	割合	40	割合	50	割合	64	割合	69	割合	70	割合	80	割合	90	割合	全体数	割合	
7に○																							
男性	5	6.6%	19	15.8%	54	26.2%	91	36.0%	120	44.1%	104	52.8%	122	49.8%	212	53.3%	107	52.7%	4	22.2%		838	42.2%
女性	2	2.9%	18	14.8%	50	28.9%	107	41.8%	138	41.7%	107	52.7%	134	52.5%	208	56.5%	108	43.4%	8	15.1%		880	42.3%
男女合計	7	4.9%	37	15.3%	104	27.4%	198	38.9%	258	42.8%	211	52.8%	256	51.2%	420	54.8%	215	47.6%	12	16.9%		1718	42.3%
全体(人)																							
男性	76		120		206		253		272		197		245		398		203		18			1988	
女性	68		122		173		256		331		203		255		368		249		53			2078	
男女合計	144		242		379		509		603		400		500		766		452		71			4066	

8. 趣味や生きがいをもち、生活にメリハリを持たせようとしていると回答した人

	10	割合	20	割合	30	割合	40	割合	50	割合	64	割合	69	割合	70	割合	80	割合	90	割合	全体数	割合	
8に○																							
男性	13	17.1%	28	23.3%	43	20.9%	38	15.0%	64	23.5%	43	21.8%	62	25.3%	154	38.7%	78	38.4%	5	27.8%		528	26.6%
女性	14	20.6%	31	25.4%	38	22.0%	46	18.0%	90	27.2%	70	34.5%	109	42.7%	167	45.4%	86	34.5%	7	13.2%		658	31.7%
男女合計	27	18.8%	59	24.4%	81	21.4%	84	16.5%	154	25.5%	113	28.3%	171	34.2%	321	41.9%	164	36.3%	12	16.9%		1186	29.2%
全体(人)																							
男性	76		120		206		253		272		197		245		398		203		18			1988	
女性	68		122		173		256		331		203		255		368		249		53			2078	
男女合計	144		242		379		509		603		400		500		766		452		71			4066	

9. 健康補助食品などを利用していると回答した人

	10	割合	20	割合	30	割合	40	割合	50	割合	64	割合	69	割合	70	割合	80	割合	90	割合	全体数	割合	
9に○																							
男性	6	7.9%	6	5.0%	28	13.6%	35	13.8%	44	16.2%	25	12.7%	56	22.9%	48	12.1%	38	18.7%	3	16.7%		289	14.5%
女性	4	5.9%	7	5.7%	31	17.9%	56	21.9%	87	26.3%	56	27.6%	65	25.5%	68	18.5%	35	14.1%	10	18.9%		419	20.2%
男女合計	10	6.9%	13	5.4%	59	15.6%	91	17.9%	131	21.7%	81	20.3%	121	24.2%	116	15.1%	73	16.2%	13	18.3%		708	17.4%
全体(人)																							
男性	76		120		206		253		272		197		245		398		203		18			1988	
女性	68		122		173		256		331		203		255		368		249		53			2078	
男女合計	144		242		379		509		603		400		500		766		452		71			4066	

10. その他と回答した人

	10	割合	20	割合	30	割合	40	割合	50	割合	64	割合	69	割合	70	割合	80	割合	90	割合	全体数	割合	
10に○																							
男性	0	0.0%	3	2.5%	1	0.5%	1	0.4%	6	2.2%	1	0.5%	8	3.3%	18	4.5%	14	6.9%	0	0.0%		52	2.6%
女性	0	0.0%	1	0.8%	1	0.6%	3	1.2%	9	2.7%	4	2.0%	10	3.9%	19	5.2%	18	7.2%	4	7.5%		69	3.3%
男女合計	0	0.0%	4	1.7%	2	0.5%	4	0.8%	15	2.5%	5	1.3%	18	3.6%	37	4.8%	32	7.1%	4	5.6%		121	3.0%
全体(人)																							
男性	76		120		206		253		272		197		245		398		203		18			1988	
女性	68		122		173		256		331		203		255		368		249		53			2078	
男女合計	144		242		379		509		603		400		500		766		452		71			4066	

11. 特に何もしていないと回答した人

	10	割合	20	割合	30	割合	40	割合	50	割合	64	割合	69	割合	70	割合	80	割合	90	割合	全体数	割合	
11に○																							
男性	23	30.3%	24	20.0%	35	17.0%	43	17.0%	29	10.7%	9	4.6%	11	4.5%	22	5.5%	13	6.4%	1	5.6%		210	10.6%
女性	20	29.4%	19	15.6%	30	17.3%	35	13.7%	27	8.2%	14	6.9%	11	4.3%	17	4.6%	26	10.4%	9	17.0%		208	10.0%
男女合計	43	29.9%	43	17.8%	65	17.2%	78	15.3%	56	9.3%	23	5.8%	22	4.4%	39	5.1%	39	8.6%	10	14.1%		418	10.3%
全体(人)																							
男性	76		120		206		253		272		197		245		398		203		18			1988	
女性	68		122		173		256		331		203		255		368		249		53			2078	
男女合計	144		242		379		509		603		400		500		766		452		71			4066	

3 「健康ふくしま21計画」の認知度（満15歳以上対象）（調査票 問3）

問3 あなたは「健康ふくしま21計画」を知っていますか。あてはまるものを1つだけ選んで○をつけてください。

1 知っている 2 聞いたことはある 3 知らない

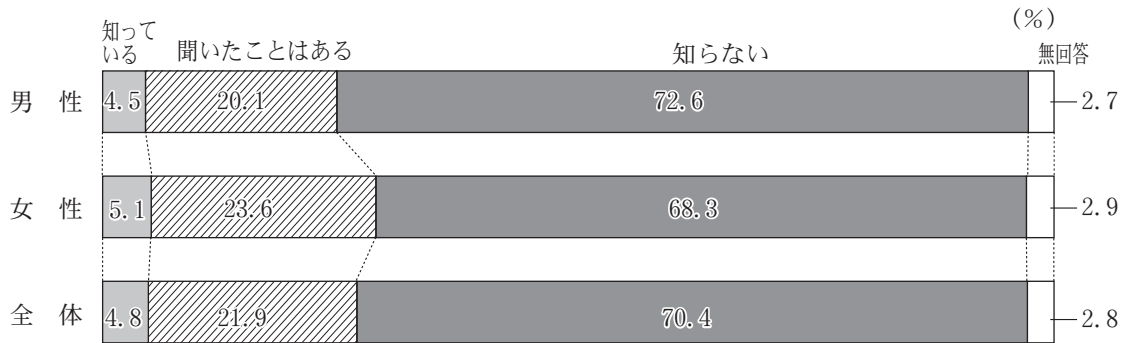

	10	割合	20	割合	30	割合	40	割合	50	割合	64	割合	69	割合	70	割合	80	割合	90	割合	全体数	割合
1と回答																						
男性	0	0.0%	4	3.3%	9	4.4%	6	2.4%	9	3.3%	10	5.1%	9	3.7%	27	6.8%	13	6.4%	3	16.7%	90	4.5%
女性	0	0.0%	7	5.7%	6	3.5%	8	3.1%	22	6.6%	8	3.9%	15	5.9%	29	7.9%	10	4.0%	2	3.8%	107	5.1%
男女合計	0	0.0%	11	4.5%	15	4.0%	14	2.8%	31	5.1%	18	4.5%	24	4.8%	56	7.3%	23	5.1%	5	7.0%	197	4.8%
2と回答																						
男性	4	5.3%	8	6.7%	29	14.1%	35	13.8%	59	21.7%	38	19.3%	51	20.8%	118	29.6%	54	26.6%	4	22.2%	400	20.1%
女性	5	7.4%	26	21.3%	33	19.1%	46	18.0%	73	22.1%	47	23.2%	71	27.8%	133	36.1%	53	21.3%	4	7.5%	491	23.6%
男女合計	9	6.3%	34	14.0%	62	16.4%	81	15.9%	132	21.9%	85	21.3%	122	24.4%	251	32.8%	107	23.7%	8	11.3%	891	21.9%
3と回答																						
男性	70	92.1%	105	87.5%	162	78.6%	204	80.6%	198	72.8%	146	74.1%	179	73.1%	244	61.3%	126	62.1%	10	55.6%	1444	72.6%
女性	61	89.7%	83	68.0%	132	76.3%	195	76.2%	229	69.2%	147	72.4%	164	64.3%	195	53.0%	174	69.9%	39	73.6%	1419	68.3%
男女合計	131	91.0%	188	77.7%	294	77.6%	399	78.4%	427	70.8%	293	73.3%	343	68.6%	439	57.3%	300	66.4%	49	69.0%	2863	70.4%
無回答																						
男性	2	2.6%	3	2.5%	6	2.9%	8	3.2%	6	2.2%	3	1.5%	6	2.4%	9	2.3%	10	4.9%	1	5.6%	54	2.7%
女性	2	2.9%	6	4.9%	2	1.2%	7	2.7%	7	2.1%	1	0.5%	5	2.0%	11	3.0%	12	4.8%	8	15.1%	61	2.9%
男女合計	4	2.8%	9	3.7%	8	2.1%	15	2.9%	13	2.2%	4	1.0%	11	2.2%	20	2.6%	22	4.9%	9	12.7%	115	2.8%
全体(人)																						
男性	76	120	206	253	272	197	245	398	203	18	1988											
女性	68	122	173	256	331	203	255	368	249	53	2078											
男女合計	144	242	379	509	603	400	500	766	452	71	4066											

県 北

	10	割合	20	割合	30	割合	40	割合	50	割合	64	割合	69	割合	70～	割合	全体数	割合
1と回答																		
男性	0	0.0%	2	5.3%	1	1.7%	1	1.4%	4	5.1%	4	7.1%	1	1.6%	8	4.7%	21	3.7%
女性	0	0.0%	3	6.7%	3	6.7%	1	1.5%	5	5.0%	2	4.0%	3	4.5%	9	5.0%	26	4.5%
男女合計	0	0.0%	5	6.0%	4	3.9%	2	1.4%	9	5.0%	6	5.7%	4	3.1%	17	4.8%	47	4.1%
2と回答																		
男性	2	6.9%	2	5.3%	10	17.2%	15	21.1%	24	30.4%	16	28.6%	14	21.9%	49	28.8%	132	23.4%
女性	1	4.3%	10	22.2%	7	15.6%	10	14.7%	25	25.0%	9	18.0%	19	28.8%	47	26.0%	128	22.1%
男女合計	3	5.8%	12	14.5%	17	16.5%	25	18.0%	49	27.4%	25	23.6%	33	25.4%	96	27.4%	260	22.7%
3と回答																		
男性	25	86.2%	32	84.2%	45	77.6%	51	71.8%	49	62.0%	35	62.5%	47	73.4%	108	63.5%	392	69.4%
女性	21	91.3%	30	66.7%	33	73.3%	54	79.4%	68	68.0%	39	78.0%	41	62.1%	115	63.5%	401	69.4%
男女合計	46	88.5%	62	74.7%	78	75.7%	105	75.5%	117	65.4%	74	69.8%	88	67.7%	223	63.5%	793	69.4%
無回答																		
男性	2	6.9%	2	5.3%	2	3.4%	4	5.6%	2	2.5%	1	1.8%	2	3.1%	5	2.9%	20	3.5%
女性	1	4.3%	2	4.4%	2	4.4%	3	4.4%	2	2.0%	0	0.0%	3	4.5%	10	5.5%	23	4.0%
男女合計	3	5.8%	4	4.8%	4	3.9%	7	5.0%	4	2.2%	1	0.9%	5	3.8%	15	4.3%	43	3.8%
全体(人)																		
男性	29		38		58		71		79		56		64		170		565	
女性	23		45		45		68		100		50		66		181		578	
男女合計	52		83		103		139		179		106		130		351		1143	

県 中

	10	割合	20	割合	30	割合	40	割合	50	割合	64	割合	69	割合	70～	割合	全体数	割合
1と回答																		
男性	0	0.0%	0	0.0%	4	7.4%	3	4.2%	1	1.5%	2	4.5%	3	5.3%	11	10.0%	24	5.4%
女性	0	0.0%	2	6.3%	2	4.3%	4	5.7%	6	7.1%	1	2.1%	4	6.1%	4	3.8%	23	4.9%
男女合計	0	0.0%	2	3.6%	6	5.9%	7	5.0%	7	4.6%	3	3.3%	7	5.7%	15	6.9%	47	5.1%
2と回答																		
男性	1	6.3%	1	4.2%	11	20.4%	9	12.7%	16	23.5%	4	9.1%	10	17.5%	28	25.5%	80	18.0%
女性	2	9.5%	5	15.6%	14	29.8%	14	20.0%	15	17.6%	11	23.4%	20	30.3%	31	29.2%	112	23.6%
男女合計	3	8.1%	6	10.7%	25	24.8%	23	16.3%	31	20.3%	15	16.5%	30	24.4%	59	27.3%	192	20.9%
3と回答																		
男性	15	93.8%	23	95.8%	39	72.2%	59	83.1%	49	72.1%	37	84.1%	42	73.7%	65	59.1%	329	74.1%
女性	19	90.5%	24	75.0%	31	66.0%	52	74.3%	63	74.1%	35	74.5%	41	62.1%	63	59.4%	328	69.2%
男女合計	34	91.9%	47	83.9%	70	69.3%	111	78.7%	112	73.2%	72	79.1%	83	67.5%	128	59.3%	657	71.6%
無回答																		
男性	0	0.0%	0	0.0%	0	0.0%	0	0.0%	2	2.9%	1	2.3%	2	3.5%	6	5.5%	11	2.5%
女性	0	0.0%	1	3.1%	0	0.0%	0	0.0%	1	1.2%	0	0.0%	1	1.5%	8	7.5%	11	2.3%
男女合計	0	0.0%	1	1.8%	0	0.0%	0	0.0%	3	2.0%	1	1.1%	3	2.4%	14	6.5%	22	2.4%
全体(人)																		
男性	16		24		54		71		68		44		57		110		444	
女性	21		32		47		70		85		47		66		106		474	
男女合計	37		56		101		141		153		91		123		216		918	

県 南

	10	割合	20	割合	30	割合	40	割合	50	割合	64	割合	69	割合	70～	割合	全体数	割合
1と回答																		
男性	0	0.0%	2	15.4%	0	0.0%	1	4.8%	1	3.4%	1	4.8%	0	0.0%	5	8.1%	10	5.4%
女性	0	0.0%	0	0.0%	0	0.0%	1	4.8%	1	3.6%	2	8.0%	2	7.7%	7	10.1%	13	7.0%
男女合計	0	0.0%	2	11.8%	0	0.0%	2	4.8%	2	3.5%	3	6.5%	2	3.9%	12	9.2%	23	6.2%
2と回答																		
男性	0	0.0%	3	23.1%	3	25.0%	0	0.0%	4	13.8%	5	23.8%	7	28.0%	18	29.0%	40	21.7%
女性	1	25.0%	1	25.0%	4	40.0%	3	14.3%	8	28.6%	9	36.0%	6	23.1%	22	31.9%	54	28.9%
男女合計	1	20.0%	4	23.5%	7	31.8%	3	7.1%	12	21.1%	14	30.4%	13	25.5%	40	30.5%	94	25.3%
3と回答																		
男性	1	100.0%	8	61.5%	8	66.7%	20	95.2%	24	82.8%	15	71.4%	17	68.0%	39	62.9%	132	71.7%
女性	3	75.0%	3	75.0%	6	60.0%	17	81.0%	18	64.3%	14	56.0%	18	69.2%	36	52.2%	115	61.5%
男女合計	4	80.0%	11	64.7%	14	63.6%	37	88.1%	42	73.7%	29	63.0%	35	68.6%	75	57.3%	247	66.6%
無回答																		
男性	0	0.0%	0	0.0%	1	8.3%	0	0.0%	0	0.0%	0	0.0%	1	4.0%	0	0.0%	2	1.1%
女性	0	0.0%	0	0.0%	0	0.0%	0	0.0%	1	3.6%	0	0.0%	0	0.0%	4	5.8%	5	2.7%
男女合計	0	0.0%	0	0.0%	1	4.5%	0	0.0%	1	1.8%	0	0.0%	1	2.0%	4	3.1%	7	1.9%
全体(人)																		
男性	1		13		12		21		29		21		25		62		184	
女性	4		4		10		21		28		25		26		69		187	
男女合計	5		17		22		42		57		46		51		131		371	

会 津

	10	割合	20	割合	30	割合	40	割合	50	割合	64	割合	69	割合	70～	割合	全体数	割合
1と回答																		
男 性	0	0.0%	0	0.0%	0	0.0%	1	4.0%	2	6.3%	0	0.0%	2	6.1%	6	5.0%	11	3.8%
女 性	0	0.0%	0	0.0%	1	4.5%	1	3.7%	3	8.1%	2	6.3%	3	9.4%	6	4.6%	16	5.4%
男女合計	0	0.0%	0	0.0%	1	2.4%	2	3.8%	5	7.2%	2	3.0%	5	7.7%	12	4.8%	27	4.6%
2と回答																		
男 性	1	8.3%	1	7.7%	2	10.0%	3	12.0%	8	25.0%	5	14.3%	8	24.2%	34	28.6%	62	21.5%
女 性	0	0.0%	4	28.6%	0	0.0%	4	14.8%	10	27.0%	6	18.8%	8	25.0%	40	30.8%	72	24.1%
男女合計	1	5.9%	5	18.5%	2	4.8%	7	13.5%	18	26.1%	11	16.4%	16	24.6%	74	29.7%	134	22.8%
3と回答																		
男 性	11	91.7%	12	92.3%	16	80.0%	20	80.0%	21	65.6%	29	82.9%	23	69.7%	74	62.2%	206	71.3%
女 性	5	100.0%	9	64.3%	21	95.5%	21	77.8%	22	59.5%	24	75.0%	21	65.6%	78	60.0%	201	67.2%
男女合計	16	94.1%	21	77.8%	37	88.1%	41	78.8%	43	62.3%	53	79.1%	44	67.7%	152	61.0%	407	69.2%
無回答																		
男 性	0	0.0%	0	0.0%	2	10.0%	1	4.0%	1	3.1%	1	2.9%	0	0.0%	5	4.2%	10	3.5%
女 性	0	0.0%	1	7.1%	0	0.0%	1	3.7%	2	5.4%	0	0.0%	0	0.0%	6	4.6%	10	3.3%
男女合計	0	0.0%	1	3.7%	2	4.8%	2	3.8%	3	4.3%	1	1.5%	0	0.0%	11	4.4%	20	3.4%
全体(人)																		
男 性	12		13		20		25		32		35		33		119		289	
女 性	5		14		22		27		37		32		32		130		299	
男女合計	17		27		42		52		69		67		65		249		588	

南 会 津

	10	割合	20	割合	30	割合	40	割合	50	割合	64	割合	69	割合	70～	割合	全体数	割合
1と回答																		
男 性	0	0.0%	0	0.0%	1	100.0%	0	0.0%	0	0.0%	0	0.0%	1	25.0%	2	10.0%	4	10.5%
女 性	0	0.0%	0	0.0%	0	0.0%	0	0.0%	1	33.3%	0	0.0%	0	0.0%	1	6.7%	2	5.7%
男女合計	0	0.0%	0	0.0%	1	50.0%	0	0.0%	1	16.7%	0	0.0%	1	10.0%	3	8.6%	6	8.2%
2と回答																		
男 性	0	0.0%	0	0.0%	0	0.0%	1	33.3%	0	0.0%	1	33.3%	0	0.0%	4	20.0%	6	15.8%
女 性	1	33.3%	0	0.0%	0	0.0%	1	20.0%	0	0.0%	0	0.0%	3	50.0%	2	13.3%	7	20.0%
男女合計	1	20.0%	0	0.0%	0	0.0%	2	25.0%	0	0.0%	1	20.0%	3	30.0%	6	17.1%	13	17.8%
3と回答																		
男 性	2	100.0%	2	100.0%	0	0.0%	2	66.7%	3	100.0%	2	66.7%	3	75.0%	14	70.0%	28	73.7%
女 性	2	66.7%	0	0.0%	1	100.0%	4	80.0%	2	66.7%	2	100.0%	3	50.0%	11	73.3%	25	71.4%
男女合計	4	80.0%	2	100.0%	1	50.0%	6	75.0%	5	83.3%	4	80.0%	6	60.0%	25	71.4%	53	72.6%
無回答																		
男 性	0	0.0%	0	0.0%	0	0.0%	0	0.0%	0	0.0%	0	0.0%	0	0.0%	0	0.0%	0	0.0%
女 性	0	0.0%	0	0.0%	0	0.0%	0	0.0%	0	0.0%	0	0.0%	0	0.0%	1	6.7%	1	2.9%
男女合計	0	0.0%	0	0.0%	0	0.0%	0	0.0%	0	0.0%	0	0.0%	0	0.0%	1	2.9%	1	1.4%
全体(人)																		
男 性	2		2		1		3		3		3		4		20		38	
女 性	3		0		1		5		3		2		6		15		35	
男女合計	5		2		2		8		6		5		10		35		73	

相 双

	10	割合	20	割合	30	割合	40	割合	50	割合	64	割合	69	割合	70～	割合	全体数	割合
1と回答																		
男 性	0	0.0%	0	0.0%	0	0.0%	0	0.0%	0	0.0%	1	7.7%	1	4.0%	5	12.8%	7	5.8%
女 性	0	0.0%	0	0.0%	0	0.0%	0	0.0%	3	14.3%	0	0.0%	3	13.0%	5	10.4%	11	8.3%
男女合計	0	0.0%	0	0.0%	0	0.0%	0	0.0%	3	9.1%	1	3.6%	4	8.3%	10	11.5%	18	7.1%
2と回答																		
男 性	0	0.0%	1	11.1%	2	20.0%	2	25.0%	0	0.0%	3	23.1%	5	20.0%	15	38.5%	28	23.3%
女 性	0	0.0%	0	0.0%	3	37.5%	2	18.2%	4	19.0%	5	33.3%	8	34.8%	13	27.1%	35	26.5%
男女合計	0	0.0%	1	7.1%	5	27.8%	4	21.1%	4	12.1%	8	28.6%	13	27.1%	28	32.2%	63	25.0%
3と回答																		
男 性	4	100.0%	8	88.9%	8	80.0%	4	50.0%	12	100.0%	9	69.2%	18	72.0%	19	48.7%	82	68.3%
女 性	1	100.0%	5	100.0%	5	62.5%	7	63.6%	14	66.7%	10	66.7%	12	52.2%	30	62.5%	84	63.6%
男女合計	5	100.0%	13	92.9%	13	72.2%	11	57.9%	26	78.8%	19	67.9%	30	62.5%	49	56.3%	166	65.9%
無回答																		
男 性	0	0.0%	0	0.0%	0	0.0%	2	25.0%	0	0.0%	0	0.0%	1	4.0%	0	0.0%	3	2.5%
女 性	0	0.0%	0	0.0%	0	0.0%	2	18.2%	0	0.0%	0	0.0%	0	0.0%	0	0.0%	2	1.5%
男女合計	0	0.0%	0	0.0%	0	0.0%	4	21.1%	0	0.0%	0	0.0%	1	2.1%	0	0.0%	5	2.0%
全体(人)																		
男 性	4		9		10		8		12		13		25		39		120	
女 性	1		5		8		11		21		15		23		48		132	
男女合計	5		14		18		19		33		28		48		87		252	

いわき

	10	割合	20	割合	30	割合	40	割合	50	割合	64	割合	69	割合	70～	割合	全体数	割合
1と回答																		
男性	0	0.0%	0	0.0%	3	5.9%	0	0.0%	1	2.0%	2	8.0%	1	2.7%	6	6.1%	13	3.7%
女性	0	0.0%	2	9.1%	0	0.0%	1	1.9%	3	5.3%	1	3.1%	0	0.0%	9	7.4%	16	4.3%
男女合計	0	0.0%	2	4.7%	3	3.3%	1	0.9%	4	3.8%	3	5.3%	1	1.4%	15	6.8%	29	4.0%
2と回答																		
男性	0	0.0%	0	0.0%	1	2.0%	5	9.3%	7	14.3%	4	16.0%	7	18.9%	28	28.3%	52	14.9%
女性	0	0.0%	6	27.3%	5	12.5%	12	22.2%	11	19.3%	7	21.9%	7	19.4%	35	28.9%	83	22.3%
男女合計	0	0.0%	6	14.0%	6	6.6%	17	15.7%	18	17.0%	11	19.3%	14	19.2%	63	28.6%	135	18.7%
3と回答																		
男性	12	100.0%	20	95.2%	46	90.2%	48	88.9%	40	81.6%	19	76.0%	29	78.4%	61	61.6%	275	79.0%
女性	10	90.9%	12	54.5%	35	87.5%	40	74.1%	42	73.7%	23	71.9%	28	77.8%	75	62.0%	265	71.0%
男女合計	22	95.7%	32	74.4%	81	89.0%	88	81.5%	82	77.4%	42	73.7%	57	78.1%	136	61.8%	540	74.9%
無回答																		
男性	0	0.0%	1	4.8%	1	2.0%	1	1.9%	1	2.0%	0	0.0%	0	0.0%	4	4.0%	8	2.3%
女性	1	9.1%	2	9.1%	0	0.0%	1	1.9%	1	1.8%	1	3.1%	1	2.8%	2	1.7%	9	2.4%
男女合計	1	4.3%	3	7.0%	1	1.1%	2	1.9%	2	1.9%	1	1.8%	1	1.4%	6	2.7%	17	2.4%
全体(人)																		
男性	12		21		51		54		49		25		37		99		348	
女性	11		22		40		54		57		32		36		121		373	
男女合計	23		43		91		108		106		57		73		220		721	

全県(60歳以上・再掲)

	64	割合	69	割合	70	割合	80	割合	90	割合	全体数	割合
1と回答												
男性	10	5.1%	9	3.7%	27	6.8%	13	6.4%	3	16.7%	62	5.8%
女性	8	3.9%	15	5.9%	29	7.9%	10	4.0%	2	3.8%	64	5.7%
男女合計	18	4.5%	24	4.8%	56	7.3%	23	5.1%	5	7.0%	126	5.8%
2と回答												
男性	38	19.3%	51	20.8%	118	29.6%	54	26.6%	4	22.2%	265	25.0%
女性	47	23.2%	71	27.8%	133	36.1%	53	21.3%	4	7.5%	308	27.3%
男女合計	85	21.3%	122	24.4%	251	32.8%	107	23.7%	8	11.3%	573	26.2%
3と回答												
男性	146	74.1%	179	73.1%	244	61.3%	126	62.1%	10	55.6%	705	66.4%
女性	147	72.4%	164	64.3%	195	53.0%	174	69.9%	39	73.6%	719	63.7%
男女合計	293	73.3%	343	68.6%	439	57.3%	300	66.4%	49	69.0%	1424	65.1%
無回答												
男性	3	1.5%	6	2.4%	9	2.3%	10	4.9%	1	5.6%	29	2.7%
女性	1	0.5%	5	2.0%	11	3.0%	12	4.8%	8	15.1%	37	3.3%
男女合計	4	1.0%	11	2.2%	20	2.6%	22	4.9%	9	12.7%	66	3.0%
全体(人)												
男性	197		245		398		203		18		1061	
女性	203		255		368		249		53		1128	
男女合計	400		500		766		452		71		2189	

4 「県民健康の日」の認知度（満15歳以上対象）（調査票 問4）

問4 あなたは、福島県において、10月10日が「県民健康の日」であることを知っていますか。あてはまるものを1つだけ選んで○をつけてください。

1 知っている 2 知らない

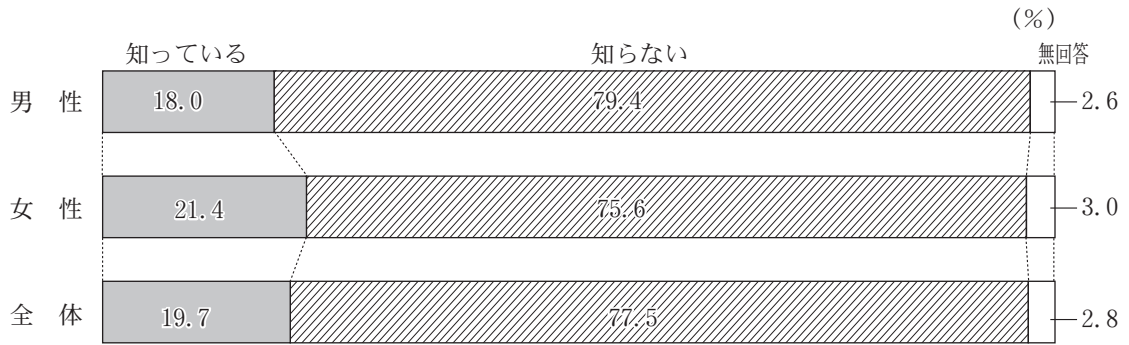

	10	割合	20	割合	30	割合	40	割合	50	割合	64	割合	69	割合	70	割合	80	割合	90	割合	全体数	割合
1と回答																						
男性	4	5.3%	10	8.3%	15	7.3%	27	10.7%	35	12.9%	38	19.3%	45	18.4%	105	26.4%	69	34.0%	9	50.0%	357	18.0%
女性	2	2.9%	12	9.8%	16	9.2%	35	13.7%	60	18.1%	35	17.2%	55	21.6%	141	38.3%	82	32.9%	6	11.3%	444	21.4%
男女合計	6	4.2%	22	9.1%	31	8.2%	62	12.2%	95	15.8%	73	18.3%	100	20.0%	246	32.1%	151	33.4%	15	21.1%	801	19.7%
2と回答																						
男性	70	92.1%	107	89.2%	185	89.8%	218	86.2%	231	84.9%	156	79.2%	194	79.2%	285	71.6%	125	61.6%	8	44.4%	1579	79.4%
女性	64	94.1%	104	85.2%	155	89.6%	213	83.2%	264	79.8%	166	81.8%	195	76.5%	219	59.5%	153	61.4%	39	73.6%	1572	75.6%
男女合計	134	93.1%	211	87.2%	340	89.7%	431	84.7%	495	82.1%	322	80.5%	389	77.8%	504	65.8%	278	61.5%	47	66.2%	3151	77.5%
無回答																						
男性	2	2.6%	3	2.5%	6	2.9%	8	3.2%	6	2.2%	3	1.5%	6	2.4%	8	2.0%	9	4.4%	1	5.6%	52	2.6%
女性	2	2.9%	6	4.9%	2	1.2%	8	3.1%	7	2.1%	2	1.0%	5	2.0%	8	2.2%	14	5.6%	8	15.1%	62	3.0%
男女合計	4	2.8%	9	3.7%	8	2.1%	16	3.1%	13	2.2%	5	1.3%	11	2.2%	16	2.1%	23	5.1%	9	12.7%	114	2.8%
全体(人)																						
男性	76	120	206	253	272	197	245	398	203	18											1988	
女性	68	122	173	256	331	203	255	368	249	53											2078	
男女合計	144	242	379	509	603	400	500	766	452	71											4066	

県 北

	10	割合	20	割合	30	割合	40	割合	50	割合	64	割合	69	割合	70～	割合	全体数	割合
1と回答																		
男性	1	3.4%	1	2.6%	3	5.2%	14	19.7%	17	21.5%	13	23.2%	15	23.4%	51	30.0%	115	20.4%
女性	0	0.0%	4	8.9%	2	4.4%	11	16.2%	19	19.0%	10	20.0%	13	19.7%	59	32.6%	118	20.4%
男女合計	1	1.9%	5	6.0%	5	4.9%	25	18.0%	36	20.1%	23	21.7%	28	21.5%	110	31.3%	233	20.4%
2と回答																		
男性	26	89.7%	35	92.1%	53	91.4%	53	74.6%	60	75.9%	42	75.0%	47	73.4%	115	67.6%	431	76.3%
女性	22	95.7%	39	86.7%	41	91.1%	54	79.4%	79	79.0%	40	80.0%	50	75.8%	115	63.5%	440	76.1%
男女合計	48	92.3%	74	89.2%	94	91.3%	107	77.0%	139	77.7%	82	77.4%	97	74.6%	230	65.5%	871	76.2%
無回答																		
男性	2	6.9%	2	5.3%	2	3.4%	4	5.6%	2	2.5%	1	1.8%	2	3.1%	4	2.4%	19	3.4%
女性	1	4.3%	2	4.4%	2	4.4%	3	4.4%	2	2.0%	0	0.0%	3	4.5%	7	3.9%	20	3.5%
男女合計	3	5.8%	4	4.8%	4	3.9%	7	5.0%	4	2.2%	1	0.9%	5	3.8%	11	3.1%	39	3.4%
全体(人)																		
男性	29		38		58		71		79		56		64		170		565	
女性	23		45		45		68		100		50		66		181		578	
男女合計	52		83		103		139		179		106		130		351		1143	

県 中

	10	割合	20	割合	30	割合	40	割合	50	割合	64	割合	69	割合	70～	割合	全体数	割合
1と回答																		
男性	2	12.5%	3	12.5%	7	13.0%	6	8.5%	12	17.6%	7	15.9%	9	15.8%	27	24.5%	73	16.4%
女性	2	9.5%	3	9.4%	6	12.8%	9	12.9%	12	14.1%	4	8.5%	14	21.2%	27	25.5%	77	16.2%
男女合計	4	10.8%	6	10.7%	13	12.9%	15	10.6%	24	15.7%	11	12.1%	23	18.7%	54	25.0%	150	16.3%
2と回答																		
男性	14	87.5%	21	87.5%	47	87.0%	65	91.5%	54	79.4%	36	81.8%	46	80.7%	77	70.0%	360	81.1%
女性	19	90.5%	28	87.5%	41	87.2%	60	85.7%	72	84.7%	42	89.4%	51	77.3%	72	67.9%	385	81.2%
男女合計	33	89.2%	49	87.5%	88	87.1%	125	88.7%	126	82.4%	78	85.7%	97	78.9%	149	69.0%	745	81.2%
無回答																		
男性	0	0.0%	0	0.0%	0	0.0%	0	0.0%	2	2.9%	1	2.3%	2	3.5%	6	5.5%	11	2.5%
女性	0	0.0%	1	3.1%	0	0.0%	1	1.4%	1	1.2%	1	2.1%	1	1.5%	7	6.6%	12	2.5%
男女合計	0	0.0%	1	1.8%	0	0.0%	1	0.7%	3	2.0%	2	2.2%	3	2.4%	13	6.0%	23	2.5%
全体(人)																		
男性	16		24		54		71		68		44		57		110		444	
女性	21		32		47		70		85		47		66		106		474	
男女合計	37		56		101		141		153		91		123		216		918	

県 南

	10	割合	20	割合	30	割合	40	割合	50	割合	64	割合	69	割合	70～	割合	全体数	割合
1と回答																		
男性	0	0.0%	3	23.1%	1	8.3%	1	4.8%	2	6.9%	4	19.0%	6	24.0%	24	38.7%	41	22.3%
女性	0	0.0%	1	25.0%	1	10.0%	6	28.6%	8	28.6%	4	16.0%	7	26.9%	33	47.8%	60	32.1%
男女合計	0	0.0%	4	23.5%	2	9.1%	7	16.7%	10	17.5%	8	17.4%	13	25.5%	57	43.5%	101	27.2%
2と回答																		
男性	1	100.0%	10	76.9%	10	83.3%	20	95.2%	27	93.1%	17	81.0%	18	72.0%	38	61.3%	141	76.6%
女性	4	100.0%	3	75.0%	9	90.0%	15	71.4%	19	67.9%	21	84.0%	19	73.1%	32	46.4%	122	65.2%
男女合計	5	100.0%	13	76.5%	19	86.4%	35	83.3%	46	80.7%	38	82.6%	37	72.5%	70	53.4%	263	70.9%
無回答																		
男性	0	0.0%	0	0.0%	1	8.3%	0	0.0%	0	0.0%	0	0.0%	1	4.0%	0	0.0%	2	1.1%
女性	0	0.0%	0	0.0%	0	0.0%	0	0.0%	1	3.6%	0	0.0%	0	0.0%	4	5.8%	5	2.7%
男女合計	0	0.0%	0	0.0%	1	4.5%	0	0.0%	1	1.8%	0	0.0%	1	2.0%	4	3.1%	7	1.9%
全体(人)																		
男性	1		13		12		21		29		21		25		62		184	
女性	4		4		10		21		28		25		26		69		187	
男女合計	5		17		22		42		57		46		51		131		371	

会 津

	10	割合	20	割合	30	割合	40	割合	50	割合	64	割合	69	割合	70～	割合	全体数	割合
1と回答																		
男性	0	0.0%	1	7.7%	1	5.0%	3	12.0%	3	9.4%	3	8.6%	9	27.3%	35	29.4%	55	19.0%
女性	0	0.0%	1	7.1%	3	13.6%	2	7.4%	7	18.9%	7	21.9%	10	31.3%	46	35.4%	76	25.4%
男女合計	0	0.0%	2	7.4%	4	9.5%	5	9.6%	10	14.5%	10	14.9%	19	29.2%	81	32.5%	131	22.3%
2と回答																		
男性	12	100.0%	12	92.3%	17	85.0%	21	84.0%	28	87.5%	31	88.6%	24	72.7%	79	66.4%	224	77.5%
女性	5	100.0%	12	85.7%	19	86.4%	24	88.9%	28	75.7%	25	78.1%	22	68.8%	77	59.2%	212	70.9%
男女合計	17	100.0%	24	88.9%	36	85.7%	45	86.5%	56	81.2%	56	83.6%	46	70.8%	156	62.7%	436	74.1%
無回答																		
男性	0	0.0%	0	0.0%	2	10.0%	1	4.0%	1	3.1%	1	2.9%	0	0.0%	5	4.2%	10	3.5%
女性	0	0.0%	1	7.1%	0	0.0%	1	3.7%	2	5.4%	0	0.0%	0	0.0%	7	5.4%	11	3.7%
男女合計	0	0.0%	1	3.7%	2	4.8%	2	3.8%	3	4.3%	1	1.5%	0	0.0%	12	4.8%	21	3.6%
全体(人)																		
男性	12		13		20		25		32		35		33		119		289	
女性	5		14		22		27		37		32		32		130		299	
男女合計	17		27		42		52		69		67		65		249		588	

南会津

	10	割合	20	割合	30	割合	40	割合	50	割合	64	割合	69	割合	70～	割合	全体数	割合
1と回答																		
男性	0	0.0%	0	0.0%	0	0.0%	0	0.0%	0	0.0%	2	66.7%	2	50.0%	6	30.0%	10	26.3%
女性	0	0.0%	0	0.0%	0	0.0%	0	0.0%	1	33.3%	0	0.0%	1	16.7%	4	26.7%	6	17.1%
男女合計	0	0.0%	0	0.0%	0	0.0%	0	0.0%	1	16.7%	2	40.0%	3	30.0%	10	28.6%	16	21.9%
2と回答																		
男性	2	100.0%	2	100.0%	1	100.0%	3	100.0%	3	100.0%	1	33.3%	2	50.0%	14	70.0%	28	73.7%
女性	3	100.0%	0	0.0%	1	100.0%	5	100.0%	2	66.7%	2	100.0%	5	83.3%	10	66.7%	28	80.0%
男女合計	5	100.0%	2	100.0%	2	100.0%	8	100.0%	5	83.3%	3	60.0%	7	70.0%	24	68.6%	56	76.7%
無回答																		
男性	0	0.0%	0	0.0%	0	0.0%	0	0.0%	0	0.0%	0	0.0%	0	0.0%	0	0.0%	0	0.0%
女性	0	0.0%	0	0.0%	0	0.0%	0	0.0%	0	0.0%	0	0.0%	0	0.0%	1	6.7%	1	2.9%
男女合計	0	0.0%	0	0.0%	0	0.0%	0	0.0%	0	0.0%	0	0.0%	0	0.0%	1	2.9%	1	1.4%
全体(人)																		
男性	2		2		1		3		3		3		4		20		38	
女性	3		0		1		5		3		2		6		15		35	
男女合計	5		2		2		8		6		5		10		35		73	

相 双

	10	割合	20	割合	30	割合	40	割合	50	割合	64	割合	69	割合	70～	割合	全体数	割合
1と回答																		
男性	1	25.0%	2	22.2%	0	0.0%	3	37.5%	1	8.3%	4	30.8%	2	8.0%	12	30.8%	25	20.8%
女性	0	0.0%	1	20.0%	1	12.5%	4	36.4%	5	23.8%	4	26.7%	5	21.7%	21	43.8%	41	31.1%
男女合計	1	20.0%	3	21.4%	1	5.6%	7	36.8%	6	18.2%	8	28.6%	7	14.6%	33	37.9%	66	26.2%
2と回答																		
男性	3	75.0%	7	77.8%	10	100.0%	3	37.5%	11	91.7%	9	69.2%	22	88.0%	27	69.2%	92	76.7%
女性	1	100.0%	4	80.0%	7	87.5%	5	45.5%	16	76.2%	11	73.3%	18	78.3%	27	56.3%	89	67.4%
男女合計	4	80.0%	11	78.6%	17	94.4%	8	42.1%	27	81.8%	20	71.4%	40	83.3%	54	62.1%	181	71.8%
無回答																		
男性	0	0.0%	0	0.0%	0	0.0%	2	25.0%	0	0.0%	0	0.0%	1	4.0%	0	0.0%	3	2.5%
女性	0	0.0%	0	0.0%	0	0.0%	2	18.2%	0	0.0%	0	0.0%	0	0.0%	0	0.0%	2	1.5%
男女合計	0	0.0%	0	0.0%	0	0.0%	4	21.1%	0	0.0%	0	0.0%	1	2.1%	0	0.0%	5	2.0%
全体(人)																		
男性	4		9		10		8		12		13		25		39		120	
女性	1		5		8		11		21		15		23		48		132	
男女合計	5		14		18		19		33		28		48		87		252	

いわき

	10	割合	20	割合	30	割合	40	割合	50	割合	64	割合	69	割合	70～	割合	全体数	割合
1と回答																		
男性	0	0.0%	0	0.0%	3	5.9%	0	0.0%	0	0.0%	5	20.0%	2	5.4%	28	28.3%	38	10.9%
女性	0	0.0%	2	9.1%	3	7.5%	3	5.6%	8	14.0%	6	18.8%	5	13.9%	39	32.2%	66	17.7%
男女合計	0	0.0%	2	4.7%	6	6.6%	3	2.8%	8	7.5%	11	19.3%	7	9.6%	67	30.5%	104	14.4%
2と回答																		
男性	12	100.0%	20	95.2%	47	92.2%	53	98.1%	48	98.0%	20	80.0%	35	94.6%	68	68.7%	303	87.1%
女性	10	90.9%	18	81.8%	37	92.5%	50	92.6%	48	84.2%	25	78.1%	30	83.3%	78	64.5%	296	79.4%
男女合計	22	95.7%	38	88.4%	84	92.3%	103	95.4%	96	90.6%	45	78.9%	65	89.0%	146	66.4%	599	83.1%
無回答																		
男性	0	0.0%	1	4.8%	1	2.0%	1	1.9%	1	2.0%	0	0.0%	0	0.0%	3	3.0%	7	2.0%
女性	1	9.1%	2	9.1%	0	0.0%	1	1.9%	1	1.8%	1	3.1%	1	2.8%	4	3.3%	11	2.9%
男女合計	1	4.3%	3	7.0%	1	1.1%	2	1.9%	2	1.9%	1	1.8%	1	1.4%	7	3.2%	18	2.5%
全体(人)																		
男性	12		21		51		54		49		25		37		99		348	
女性	11		22		40		54		57		32		36		121		373	
男女合計	23		43		91		108		106		57		73		220		721	

全県(60歳以上・再掲)

	64	割合	69	割合	70	割合	80	割合	90	割合	全体数	割合
1と回答												
男性	38	19.3%	45	18.4%	105	26.4%	69	34.0%	9	50.0%	266	25.1%
女性	35	17.2%	55	21.6%	141	38.3%	82	32.9%	6	11.3%	319	28.3%
男女合計	73	18.3%	100	20.0%	246	32.1%	151	33.4%	15	21.1%	585	26.7%
2と回答												
男性	156	79.2%	194	79.2%	285	71.6%	125	61.6%	8	44.4%	768	72.4%
女性	166	81.8%	195	76.5%	219	59.5%	153	61.4%	39	73.6%	772	68.4%
男女合計	322	80.5%	389	77.8%	504	65.8%	278	61.5%	47	66.2%	1540	70.4%
無回答												
男性	3	1.5%	6	2.4%	8	2.0%	9	4.4%	1	5.6%	27	2.5%
女性	2	1.0%	5	2.0%	8	2.2%	14	5.6%	8	15.1%	37	3.3%
男女合計	5	1.3%	11	2.2%	16	2.1%	23	5.1%	9	12.7%	64	2.9%
全体(人)												
男性	197		245		398		203		18		1061	
女性	203		255		368		249		53		1128	
男女合計	400		500		766		452		71		2189	

5 食生活（朝食）の状況（満15歳以上対象）（調査票 問5）

問5 あなたは、朝食をだいたい毎日とっていますか。

1 はい 2 いいえ

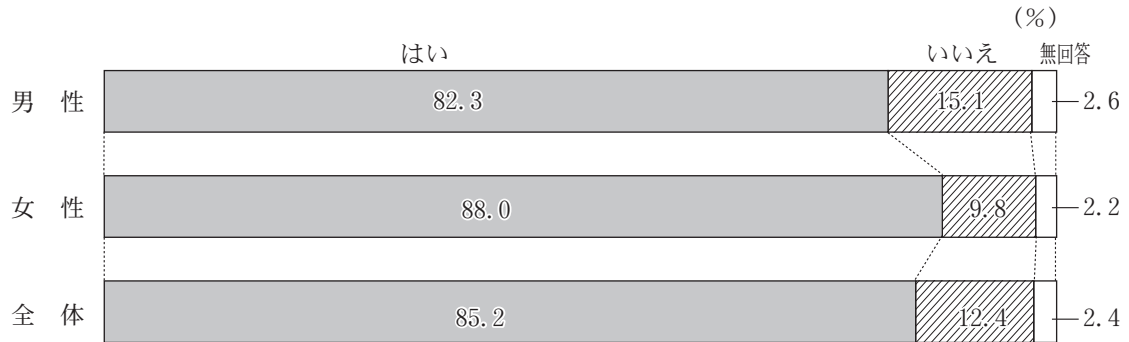

	10	割合	20	割合	30	割合	40	割合	50	割合	64	割合	69	割合	70	割合	80	割合	90	割合	全体数	割合
1と回答																						
男性	61	80.3%	71	59.2%	139	67.5%	172	68.0%	213	78.3%	171	86.8%	228	93.1%	374	94.0%	191	94.1%	16	88.9%	1636	82.3%
女性	52	76.5%	85	69.7%	140	80.9%	215	84.0%	283	85.5%	186	91.6%	236	92.5%	351	95.4%	235	94.4%	46	86.8%	1829	88.0%
男女合計	113	78.5%	156	64.5%	279	73.6%	387	76.0%	496	82.3%	357	89.3%	464	92.8%	725	94.6%	426	94.2%	62	87.3%	3465	85.2%
2と回答																						
男性	13	17.1%	46	38.3%	61	29.6%	72	28.5%	53	19.5%	23	11.7%	11	4.5%	17	4.3%	4	2.0%	1	5.6%	301	15.1%
女性	14	20.6%	31	25.4%	31	17.9%	34	13.3%	41	12.4%	16	7.9%	14	5.5%	13	3.5%	8	3.2%	2	3.8%	204	9.8%
男女合計	27	18.8%	77	31.8%	92	24.3%	106	20.8%	94	15.6%	39	9.8%	25	5.0%	30	3.9%	12	2.7%	3	4.2%	505	12.4%
無回答																						
男性	2	2.6%	3	2.5%	6	2.9%	9	3.6%	6	2.2%	3	1.5%	6	2.4%	7	1.8%	8	3.9%	1	5.6%	51	2.6%
女性	2	2.9%	6	4.9%	2	1.2%	7	2.7%	7	2.1%	1	0.5%	5	2.0%	4	1.1%	6	2.4%	5	9.4%	45	2.2%
男女合計	4	2.8%	9	3.7%	8	2.1%	16	3.1%	13	2.2%	4	1.0%	11	2.2%	11	1.4%	14	3.1%	6	8.5%	96	2.4%
全体(人)																						
男性	76	120	206	253	272	197	245	398	203	18											1988	
女性	68	122	173	256	331	203	255	368	249	53											2078	
男女合計	144	242	379	509	603	400	500	766	452	71											4066	

県 北

	10	割合	20	割合	30	割合	40	割合	50	割合	64	割合	69	割合	70～	割合	全体数	割合
1と回答																		
男性	24	82.8%	23	60.5%	36	62.1%	50	70.4%	58	73.4%	51	91.1%	62	96.9%	161	94.7%	465	82.3%
女性	21	91.3%	32	71.1%	38	84.4%	59	86.8%	88	88.0%	48	96.0%	58	87.9%	169	93.4%	513	88.8%
男女合計	45	86.5%	55	66.3%	74	71.8%	109	78.4%	146	81.6%	99	93.4%	120	92.3%	330	94.0%	978	85.6%
2と回答																		
男性	3	10.3%	13	34.2%	20	34.5%	17	23.9%	19	24.1%	4	7.1%	0	0.0%	5	2.9%	81	14.3%
女性	1	4.3%	11	24.4%	5	11.1%	6	8.8%	10	10.0%	2	4.0%	5	7.6%	8	4.4%	48	8.3%
男女合計	4	7.7%	24	28.9%	25	24.3%	23	16.5%	29	16.2%	6	5.7%	5	3.8%	13	3.7%	129	11.3%
無回答																		
男性	2	6.9%	2	5.3%	2	3.4%	4	5.6%	2	2.5%	1	1.8%	2	3.1%	4	2.4%	19	3.4%
女性	1	4.3%	2	4.4%	2	4.4%	3	4.4%	2	2.0%	0	0.0%	3	4.5%	4	2.2%	17	2.9%
男女合計	3	5.8%	4	4.8%	4	3.9%	7	5.0%	4	2.2%	1	0.9%	5	3.8%	8	2.3%	36	3.1%
全体(人)																		
男性	29		38		58		71		79		56		64		170		565	
女性	23		45		45		68		100		50		66		181		578	
男女合計	52		83		103		139		179		106		130		351		1143	

県 中

	10	割合	20	割合	30	割合	40	割合	50	割合	64	割合	69	割合	70～	割合	全体数	割合
1と回答																		
男性	13	81.3%	15	62.5%	39	72.2%	49	69.0%	52	76.5%	39	88.6%	52	91.2%	102	92.7%	361	81.3%
女性	14	66.7%	20	62.5%	39	83.0%	63	90.0%	74	87.1%	42	89.4%	62	93.9%	100	94.3%	414	87.3%
男女合計	27	73.0%	35	62.5%	78	77.2%	112	79.4%	126	82.4%	81	89.0%	114	92.7%	202	93.5%	775	84.4%
2と回答																		
男性	3	18.8%	9	37.5%	15	27.8%	21	29.6%	14	20.6%	4	9.1%	3	5.3%	4	3.6%	73	16.4%
女性	7	33.3%	11	34.4%	8	17.0%	7	10.0%	10	11.8%	5	10.6%	3	4.5%	3	2.8%	54	11.4%
男女合計	10	27.0%	20	35.7%	23	22.8%	28	19.9%	24	15.7%	9	9.9%	6	4.9%	7	3.2%	127	13.8%
無回答																		
男性	0	0.0%	0	0.0%	0	0.0%	1	1.4%	2	2.9%	1	2.3%	2	3.5%	4	3.6%	10	2.3%
女性	0	0.0%	1	3.1%	0	0.0%	0	0.0%	1	1.2%	0	0.0%	1	1.5%	3	2.8%	6	1.3%
男女合計	0	0.0%	1	1.8%	0	0.0%	1	0.7%	3	2.0%	1	1.1%	3	2.4%	7	3.2%	16	1.7%
全体(人)																		
男性	16		24		54		71		68		44		57		110		444	
女性	21		32		47		70		85		47		66		106		474	
男女合計	37		56		101		141		153		91		123		216		918	

県 南

	10	割合	20	割合	30	割合	40	割合	50	割合	64	割合	69	割合	70～	割合	全体数	割合
1と回答																		
男性	0	0.0%	7	53.8%	9	75.0%	12	57.1%	23	79.3%	20	95.2%	23	92.0%	60	96.8%	154	83.7%
女性	3	75.0%	4	100.0%	7	70.0%	17	81.0%	22	78.6%	24	96.0%	23	88.5%	66	95.7%	166	88.8%
男女合計	3	60.0%	11	64.7%	16	72.7%	29	69.0%	45	78.9%	44	95.7%	46	90.2%	126	96.2%	320	86.3%
2と回答																		
男性	1	100.0%	6	46.2%	2	16.7%	9	42.9%	6	20.7%	1	4.8%	1	4.0%	2	3.2%	28	15.2%
女性	1	25.0%	0	0.0%	3	30.0%	4	19.0%	5	17.9%	1	4.0%	3	11.5%	1	1.4%	18	9.6%
男女合計	2	40.0%	6	35.3%	5	22.7%	13	31.0%	11	19.3%	2	4.3%	4	7.8%	3	2.3%	46	12.4%
無回答																		
男性	0	0.0%	0	0.0%	1	8.3%	0	0.0%	0	0.0%	0	0.0%	1	4.0%	0	0.0%	2	1.1%
女性	0	0.0%	0	0.0%	0	0.0%	0	0.0%	1	3.6%	0	0.0%	0	0.0%	2	2.9%	3	1.6%
男女合計	0	0.0%	0	0.0%	1	4.5%	0	0.0%	1	1.8%	0	0.0%	1	2.0%	2	1.5%	5	1.3%
全体(人)																		
男性	1		13		12		21		29		21		25		62		184	
女性	4		4		10		21		28		25		26		69		187	
男女合計	5		17		22		42		57		46		51		131		371	

会 津

	10	割合	20	割合	30	割合	40	割合	50	割合	64	割合	69	割合	70～	割合	全体数	割合
1と回答																		
男性	10	83.3%	9	69.2%	14	70.0%	21	84.0%	25	78.1%	24	68.6%	33	100.0%	108	90.8%	244	84.4%
女性	4	80.0%	10	71.4%	18	81.8%	21	77.8%	31	83.8%	29	90.6%	31	96.9%	122	93.8%	266	89.0%
男女合計	14	82.4%	19	70.4%	32	76.2%	42	80.8%	56	81.2%	53	79.1%	64	98.5%	230	92.4%	510	86.7%
2と回答																		
男性	2	16.7%	4	30.8%	4	20.0%	3	12.0%	6	18.8%	10	28.6%	0	0.0%	6	5.0%	35	12.1%
女性	1	20.0%	3	21.4%	4	18.2%	5	18.5%	4	10.8%	3	9.4%	1	3.1%	4	3.1%	25	8.4%
男女合計	3	17.6%	7	25.9%	8	19.0%	8	15.4%	10	14.5%	13	19.4%	1	1.5%	10	4.0%	60	10.2%
無回答																		
男性	0	0.0%	0	0.0%	2	10.0%	1	4.0%	1	3.1%	1	2.9%	0	0.0%	5	4.2%	10	3.5%
女性	0	0.0%	1	7.1%	0	0.0%	1	3.7%	2	5.4%	0	0.0%	0	0.0%	4	3.1%	8	2.7%
男女合計	0	0.0%	1	3.7%	2	4.8%	2	3.8%	3	4.3%	1	1.5%	0	0.0%	9	3.6%	18	3.1%
全体(人)																		
男性	12		13		20		25		32		35		33		119		289	
女性	5		14		22		27		37		32		32		130		299	
男女合計	17		27		42		52		69		67		65		249		588	

南会津

	10	割合	20	割合	30	割合	40	割合	50	割合	64	割合	69	割合	70～	割合	全体数	割合
1と回答																		
男性	1	50.0%	2	100.0%	1	100.0%	2	66.7%	3	100.0%	3	100.0%	4	100.0%	20	100.0%	36	94.7%
女性	2	66.7%	0	0.0%	1	100.0%	4	80.0%	3	100.0%	1	50.0%	6	100.0%	15	100.0%	32	91.4%
男女合計	3	60.0%	2	100.0%	2	100.0%	6	75.0%	6	100.0%	4	80.0%	10	100.0%	35	100.0%	68	93.2%
2と回答																		
男性	1	50.0%	0	0.0%	0	0.0%	1	33.3%	0	0.0%	0	0.0%	0	0.0%	0	0.0%	2	5.3%
女性	1	33.3%	0	0.0%	0	0.0%	1	20.0%	0	0.0%	1	50.0%	0	0.0%	0	0.0%	3	8.6%
男女合計	2	40.0%	0	0.0%	0	0.0%	2	25.0%	0	0.0%	1	20.0%	0	0.0%	0	0.0%	5	6.8%
無回答																		
男性	0	0.0%	0	0.0%	0	0.0%	0	0.0%	0	0.0%	0	0.0%	0	0.0%	0	0.0%	0	0.0%
女性	0	0.0%	0	0.0%	0	0.0%	0	0.0%	0	0.0%	0	0.0%	0	0.0%	0	0.0%	0	0.0%
男女合計	0	0.0%	0	0.0%	0	0.0%	0	0.0%	0	0.0%	0	0.0%	0	0.0%	0	0.0%	0	0.0%
全体(人)																		
男性	2		2		1		3		3		3		4		20		38	
女性	3		0		1		5		3		2		6		15		35	
男女合計	5		2		2		8		6		5		10		35		73	

相 双

	10	割合	20	割合	30	割合	40	割合	50	割合	64	割合	69	割合	70～	割合	全体数	割合
1と回答																		
男性	2	50.0%	4	44.4%	6	60.0%	5	62.5%	11	91.7%	13	100.0%	23	92.0%	39	100.0%	103	85.8%
女性	1	100.0%	3	60.0%	7	87.5%	8	72.7%	21	100.0%	15	100.0%	22	95.7%	46	95.8%	123	93.2%
男女合計	3	60.0%	7	50.0%	13	72.2%	13	68.4%	32	97.0%	28	100.0%	45	93.8%	85	97.7%	226	89.7%
2と回答																		
男性	2	50.0%	5	55.6%	4	40.0%	1	12.5%	1	8.3%	0	0.0%	1	4.0%	0	0.0%	14	11.7%
女性	0	0.0%	2	40.0%	1	12.5%	1	9.1%	0	0.0%	0	0.0%	1	4.3%	2	4.2%	7	5.3%
男女合計	2	40.0%	7	50.0%	5	27.8%	2	10.5%	1	3.0%	0	0.0%	2	4.2%	2	2.3%	21	8.3%
無回答																		
男性	0	0.0%	0	0.0%	0	0.0%	2	25.0%	0	0.0%	0	0.0%	1	4.0%	0	0.0%	3	2.5%
女性	0	0.0%	0	0.0%	0	0.0%	2	18.2%	0	0.0%	0	0.0%	0	0.0%	0	0.0%	2	1.5%
男女合計	0	0.0%	0	0.0%	0	0.0%	4	21.1%	0	0.0%	0	0.0%	1	2.1%	0	0.0%	5	2.0%
全体(人)																		
男性	4		9		10		8		12		13		25		39		120	
女性	1		5		8		11		21		15		23		48		132	
男女合計	5		14		18		19		33		28		48		87		252	

いわき

	10	割合	20	割合	30	割合	40	割合	50	割合	64	割合	69	割合	70～	割合	全体数	割合
1と回答																		
男性	11	91.7%	11	52.4%	34	66.7%	33	61.1%	41	83.7%	21	84.0%	31	83.8%	91	91.9%	273	78.4%
女性	7	63.6%	16	72.7%	30	75.0%	43	79.6%	44	77.2%	27	84.4%	34	94.4%	114	94.2%	315	84.5%
男女合計	18	78.3%	27	62.8%	64	70.3%	76	70.4%	85	80.2%	48	84.2%	65	89.0%	205	93.2%	588	81.6%
2と回答																		
男性	1	8.3%	9	42.9%	16	31.4%	20	37.0%	7	14.3%	4	16.0%	6	16.2%	5	5.1%	68	19.5%
女性	3	27.3%	4	18.2%	10	25.0%	10	18.5%	12	21.1%	4	12.5%	1	2.8%	5	4.1%	49	13.1%
男女合計	4	17.4%	13	30.2%	26	28.6%	30	27.8%	19	17.9%	8	14.0%	7	9.6%	10	4.5%	117	16.2%
無回答																		
男性	0	0.0%	1	4.8%	1	2.0%	1	1.9%	1	2.0%	0	0.0%	0	0.0%	3	3.0%	7	2.0%
女性	1	9.1%	2	9.1%	0	0.0%	1	1.9%	1	1.8%	1	3.1%	1	2.8%	2	1.7%	9	2.4%
男女合計	1	4.3%	3	7.0%	1	1.1%	2	1.9%	2	1.9%	1	1.8%	1	1.4%	5	2.3%	16	2.2%
全体(人)																		
男性	12		21		51		54		49		25		37		99		348	
女性	11		22		40		54		57		32		36		121		373	
男女合計	23		43		91		108		106		57		73		220		721	

全県 (60歳以上・再掲)

	64	割合	69	割合	70	割合	80	割合	90	割合	全体数	割合
1と回答												
男性	171	86.8%	228	93.1%	374	94.0%	191	94.1%	16	88.9%	980	92.4%
女性	186	91.6%	236	92.5%	351	95.4%	235	94.4%	46	86.8%	1054	93.4%
男女合計	357	89.3%	464	92.8%	725	94.6%	426	94.2%	62	87.3%	2034	92.9%
2と回答												
男性	23	11.7%	11	4.5%	17	4.3%	4	2.0%	1	5.6%	56	5.3%
女性	16	7.9%	14	5.5%	13	3.5%	8	3.2%	2	3.8%	53	4.7%
男女合計	39	9.8%	25	5.0%	30	3.9%	12	2.7%	3	4.2%	109	5.0%
無回答												
男性	3	1.5%	6	2.4%	7	1.8%	8	3.9%	1	5.6%	25	2.4%
女性	1	0.5%	5	2.0%	4	1.1%	6	2.4%	5	9.4%	21	1.9%
男女合計	4	1.0%	11	2.2%	11	1.4%	14	3.1%	6	8.5%	46	2.1%
全体(人)												
男性	197		245		398		203		18		1061	
女性	203		255		368		249		53		1128	
男女合計	400		500		766		452		71		2189	

6 食生活（朝食・夕食）の状況（満15歳以上対象）（調査票 問6）

問6 あなたは、朝食を家族とどのくらい一緒に食べていますか。

- 1 ほとんど毎日 2 週に4～5日 3 週に2～3日
4 週に1日程度 5 ほとんどない

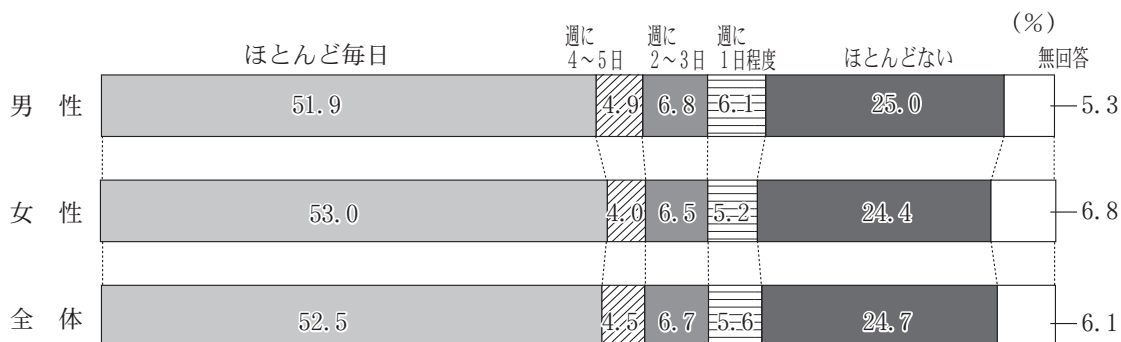

	10	割合	20	割合	30	割合	40	割合	50	割合	64	割合	69	割合	70	割合	80	割合	90	割合	全体数	割合
1と回答																						
男性	32	42.1%	25	20.8%	62	30.1%	85	33.6%	111	40.8%	109	55.3%	156	63.7%	295	74.1%	148	72.9%	9	50.0%	1032	51.9%
女性	29	42.6%	39	32.0%	88	50.9%	137	53.5%	149	45.0%	115	56.7%	176	69.0%	218	59.2%	125	50.2%	26	49.1%	1102	53.0%
男女合計	61	42.4%	64	26.4%	150	39.6%	222	43.6%	260	43.1%	224	56.0%	332	66.4%	513	67.0%	273	60.4%	35	49.3%	2134	52.5%
2と回答																						
男性	8	10.5%	3	2.5%	12	5.8%	20	7.9%	18	6.6%	6	3.0%	8	3.3%	15	3.8%	7	3.4%	0	0.0%	97	4.9%
女性	3	4.4%	9	7.4%	14	8.1%	12	4.7%	14	4.2%	12	5.9%	6	2.4%	8	2.2%	5	2.0%	1	1.9%	84	4.0%
男女合計	11	7.6%	12	5.0%	26	6.9%	32	6.3%	32	5.3%	18	4.5%	14	2.8%	23	3.0%	12	2.7%	1	1.4%	181	4.5%
3と回答																						
男性	7	9.2%	16	13.3%	25	12.1%	27	10.7%	22	8.1%	10	5.1%	14	5.7%	8	2.0%	5	2.5%	1	5.6%	135	6.8%
女性	8	11.8%	13	10.7%	10	5.8%	31	12.1%	32	9.7%	12	5.9%	10	3.9%	12	3.3%	6	2.4%	2	3.8%	136	6.5%
男女合計	15	10.4%	29	12.0%	35	9.2%	58	11.4%	54	9.0%	22	5.5%	24	4.8%	20	2.6%	11	2.4%	3	4.2%	271	6.7%
4と回答																						
男性	3	3.9%	9	7.5%	25	12.1%	33	13.0%	21	7.7%	15	7.6%	8	3.3%	4	1.0%	3	1.5%	0	0.0%	121	6.1%
女性	4	5.9%	12	9.8%	9	5.2%	18	7.0%	27	8.2%	14	6.9%	3	1.2%	14	3.8%	5	2.0%	2	3.8%	108	5.2%
男女合計	7	4.9%	21	8.7%	34	9.0%	51	10.0%	48	8.0%	29	7.3%	11	2.2%	18	2.3%	8	1.8%	2	2.8%	229	5.6%
5と回答																						
男性	22	28.9%	61	50.8%	72	35.0%	71	28.1%	87	32.0%	47	23.9%	49	20.0%	56	14.1%	26	12.8%	6	33.3%	497	25.0%
女性	22	32.4%	44	36.1%	44	25.4%	48	18.8%	96	29.0%	43	21.2%	47	18.4%	80	21.7%	69	27.7%	14	26.4%	507	24.4%
男女合計	44	30.6%	105	43.4%	116	30.6%	119	23.4%	183	30.3%	90	22.5%	96	19.2%	136	17.8%	95	21.0%	20	28.2%	1004	24.7%
無回答																						
男性	4	5.3%	6	5.0%	10	4.9%	17	6.7%	13	4.8%	10	5.1%	10	4.1%	20	5.0%	14	6.9%	2	11.1%	106	5.3%
女性	2	2.9%	5	4.1%	8	4.6%	10	3.9%	13	3.9%	7	3.4%	13	5.1%	36	9.8%	39	15.7%	8	15.1%	141	6.8%
男女合計	6	4.2%	11	4.5%	18	4.7%	27	5.3%	26	4.3%	17	4.3%	23	4.6%	56	7.3%	53	11.7%	10	14.1%	247	6.1%
全体(人)																						
男性	76		120		206		253		272		197		245		398		203		18		1988	
女性	68		122		173		256		331		203		255		368		249		53		2078	
男女合計	144		242		379		509		603		400		500		766		452		71		4066	

県 北

	10	割合	20	割合	30	割合	40	割合	50	割合	64	割合	69	割合	70～	割合	全体数	割合
1と回答																		
男性	13	44.8%	9	23.7%	14	24.1%	25	35.2%	37	46.8%	29	51.8%	45	70.3%	127	74.7%	299	52.9%
女性	14	60.9%	15	33.3%	21	46.7%	38	55.9%	45	45.0%	28	56.0%	43	65.2%	107	59.1%	311	53.8%
男女合計	27	51.9%	24	28.9%	35	34.0%	63	45.3%	82	45.8%	57	53.8%	88	67.7%	234	66.7%	610	53.4%
2と回答																		
男性	3	10.3%	1	2.6%	3	5.2%	2	2.8%	6	7.6%	2	3.6%	1	1.6%	5	2.9%	23	4.1%
女性	1	4.3%	5	11.1%	5	11.1%	3	4.4%	8	8.0%	2	4.0%	0	0.0%	1	0.6%	25	4.3%
男女合計	4	7.7%	6	7.2%	8	7.8%	5	3.6%	14	7.8%	4	3.8%	1	0.8%	6	1.7%	48	4.2%
3と回答																		
男性	3	10.3%	6	15.8%	11	19.0%	9	12.7%	5	6.3%	4	7.1%	5	7.8%	5	2.9%	48	8.5%
女性	2	8.7%	4	8.9%	2	4.4%	9	13.2%	10	10.0%	3	6.0%	5	7.6%	3	1.7%	38	6.6%
男女合計	5	9.6%	10	12.0%	13	12.6%	18	12.9%	15	8.4%	7	6.6%	10	7.7%	8	2.3%	86	7.5%
4と回答																		
男性	1	3.4%	3	7.9%	5	8.6%	8	11.3%	6	7.6%	5	8.9%	4	6.3%	1	0.6%	33	5.8%
女性	2	8.7%	5	11.1%	2	4.4%	4	5.9%	9	9.0%	3	6.0%	0	0.0%	4	2.2%	29	5.0%
男女合計	3	5.8%	8	9.6%	7	6.8%	12	8.6%	15	8.4%	8	7.5%	4	3.1%	5	1.4%	62	5.4%
5と回答																		
男性	5	17.2%	15	39.5%	23	39.7%	17	23.9%	20	25.3%	13	23.2%	6	9.4%	25	14.7%	124	21.9%
女性	3	13.0%	14	31.1%	11	24.4%	10	14.7%	25	25.0%	12	24.0%	14	21.2%	46	25.4%	135	23.4%
男女合計	8	15.4%	29	34.9%	34	33.0%	27	19.4%	45	25.1%	25	23.6%	20	15.4%	71	20.2%	259	22.7%
無回答																		
男性	4	13.8%	4	10.5%	2	3.4%	10	14.1%	5	6.3%	3	5.4%	3	4.7%	7	4.1%	38	6.7%
女性	1	4.3%	2	4.4%	4	8.9%	4	5.9%	3	3.0%	2	4.0%	4	6.1%	20	11.0%	40	6.9%
男女合計	5	9.6%	6	7.2%	6	5.8%	14	10.1%	8	4.5%	5	4.7%	7	5.4%	27	7.7%	78	6.8%
全体(人)																		
男性	29		38		58		71		79		56		64		170		565	
女性	23		45		45		68		100		50		66		181		578	
男女合計	52		83		103		139		179		106		130		351		1143	

県 中

	10	割合	20	割合	30	割合	40	割合	50	割合	64	割合	69	割合	70～	割合	全体数	割合
1と回答																		
男性	8	50.0%	7	29.2%	18	33.3%	23	32.4%	25	36.8%	28	63.6%	34	59.6%	81	73.6%	224	50.5%
女性	7	33.3%	9	28.1%	22	46.8%	38	54.3%	34	40.0%	28	59.6%	45	68.2%	53	50.0%	236	49.8%
男女合計	15	40.5%	16	28.6%	40	39.6%	61	43.3%	59	38.6%	56	61.5%	79	64.2%	134	62.0%	460	50.1%
2と回答																		
男性	4	25.0%	0	0.0%	4	7.4%	6	8.5%	2	2.9%	0	0.0%	4	7.0%	4	3.6%	24	5.4%
女性	1	4.8%	4	12.5%	5	10.6%	4	5.7%	4	4.7%	1	2.1%	3	4.5%	2	1.9%	24	5.1%
男女合計	5	13.5%	4	7.1%	9	8.9%	10	7.1%	6	3.9%	1	1.1%	7	5.7%	6	2.8%	48	5.2%
3と回答																		
男性	1	6.3%	1	4.2%	7	13.0%	8	11.3%	7	10.3%	3	6.8%	2	3.5%	3	2.7%	32	7.2%
女性	2	9.5%	4	12.5%	3	6.4%	7	10.0%	7	8.2%	4	8.5%	2	3.0%	3	2.8%	32	6.8%
男女合計	3	8.1%	5	8.9%	10	9.9%	15	10.6%	14	9.2%	7	7.7%	4	3.3%	6	2.8%	64	7.0%
4と回答																		
男性	2	12.5%	1	4.2%	6	11.1%	10	14.1%	3	4.4%	3	6.8%	1	1.8%	0	0.0%	26	5.9%
女性	1	4.8%	2	6.3%	3	6.4%	6	8.6%	7	8.2%	3	6.4%	1	1.5%	5	4.7%	28	5.9%
男女合計	3	8.1%	3	5.4%	9	8.9%	16	11.3%	10	6.5%	6	6.6%	2	1.6%	5	2.3%	54	5.9%
5と回答																		
男性	1	6.3%	14	58.3%	17	31.5%	23	32.4%	29	42.6%	9	20.5%	12	21.1%	17	15.5%	122	27.5%
女性	10	47.6%	13	40.6%	13	27.7%	14	20.0%	30	35.3%	9	19.1%	13	19.7%	31	29.2%	133	28.1%
男女合計	11	29.7%	27	48.2%	30	29.7%	37	26.2%	59	38.6%	18	19.8%	25	20.3%	48	22.2%	255	27.8%
無回答																		
男性	0	0.0%	1	4.2%	2	3.7%	1	1.4%	2	2.9%	1	2.3%	4	7.0%	5	4.5%	16	3.6%
女性	0	0.0%	0	0.0%	1	2.1%	1	1.4%	3	3.5%	2	4.3%	2	3.0%	12	11.3%	21	4.4%
男女合計	0	0.0%	1	1.8%	3	3.0%	2	1.4%	5	3.3%	3	3.3%	6	4.9%	17	7.9%	37	4.0%
全体(人)																		
男性	16		24		54		71		68		44		57		110		444	
女性	21		32		47		70		85		47		66		106		474	
男女合計	37		56		101		141		153		91		123		216		918	

県 南

	10	割合	20	割合	30	割合	40	割合	50	割合	64	割合	69	割合	70～	割合	全体数	割合
1と回答																		
男性	0	0.0%	2	15.4%	3	25.0%	7	33.3%	13	44.8%	13	61.9%	16	64.0%	52	83.9%	106	57.6%
女性	0	0.0%	2	50.0%	5	50.0%	9	42.9%	9	32.1%	16	64.0%	20	76.9%	48	69.6%	109	58.3%
男女合計	0	0.0%	4	23.5%	8	36.4%	16	38.1%	22	38.6%	29	63.0%	36	70.6%	100	76.3%	215	58.0%
2と回答																		
男性	0	0.0%	0	0.0%	0	0.0%	3	14.3%	2	6.9%	1	4.8%	0	0.0%	2	3.2%	8	4.3%
女性	1	25.0%	0	0.0%	1	10.0%	1	4.8%	1	3.6%	3	12.0%	0	0.0%	0	0.0%	7	3.7%
男女合計	1	20.0%	0	0.0%	1	4.5%	4	9.5%	3	5.3%	4	8.7%	0	0.0%	2	1.5%	15	4.0%
3と回答																		
男性	1	100.0%	0	0.0%	1	8.3%	2	9.5%	3	10.3%	2	9.5%	2	8.0%	2	3.2%	13	7.1%
女性	2	50.0%	0	0.0%	1	10.0%	4	19.0%	4	14.3%	0	0.0%	1	3.8%	0	0.0%	12	6.4%
男女合計	3	60.0%	0	0.0%	2	9.1%	6	14.3%	7	12.3%	2	4.3%	3	5.9%	2	1.5%	25	6.7%
4と回答																		
男性	0	0.0%	2	15.4%	3	25.0%	5	23.8%	3	10.3%	0	0.0%	1	4.0%	1	1.6%	15	8.2%
女性	0	0.0%	0	0.0%	0	0.0%	3	14.3%	3	10.7%	2	8.0%	1	3.8%	1	1.4%	10	5.3%
男女合計	0	0.0%	2	11.8%	3	13.6%	8	19.0%	6	10.5%	2	4.3%	2	3.9%	2	1.5%	25	6.7%
5と回答																		
男性	0	0.0%	9	69.2%	4	33.3%	4	19.0%	8	27.6%	4	19.0%	4	16.0%	3	4.8%	36	19.6%
女性	1	25.0%	2	50.0%	3	30.0%	4	19.0%	8	28.6%	3	12.0%	3	11.5%	11	15.9%	35	18.7%
男女合計	1	20.0%	11	64.7%	7	31.8%	8	19.0%	16	28.1%	7	15.2%	7	13.7%	14	10.7%	71	19.1%
無回答																		
男性	0	0.0%	0	0.0%	1	8.3%	0	0.0%	0	0.0%	1	4.8%	2	8.0%	2	3.2%	6	3.3%
女性	0	0.0%	0	0.0%	0	0.0%	0	0.0%	3	10.7%	1							

会 津

	10	割合	20	割合	30	割合	40	割合	50	割合	64	割合	69	割合	70～	割合	全体数	割合
1と回答																		
男性	4	33.3%	3	23.1%	8	40.0%	14	56.0%	15	46.9%	16	45.7%	22	66.7%	76	63.9%	158	54.7%
女性	2	40.0%	6	42.9%	15	68.2%	16	59.3%	22	59.5%	16	50.0%	23	71.9%	64	49.2%	164	54.8%
男女合計	6	35.3%	9	33.3%	23	54.8%	30	57.7%	37	53.6%	32	47.8%	45	69.2%	140	56.2%	322	54.8%
2と回答																		
男性	0	0.0%	0	0.0%	1	5.0%	1	4.0%	5	15.6%	0	0.0%	0	0.0%	1	0.8%	8	2.8%
女性	0	0.0%	0	0.0%	2	9.1%	0	0.0%	0	0.0%	2	6.3%	0	0.0%	3	2.3%	7	2.3%
男女合計	0	0.0%	0	0.0%	3	7.1%	1	1.9%	5	7.2%	2	3.0%	0	0.0%	4	1.6%	15	2.6%
3と回答																		
男性	0	0.0%	2	15.4%	2	10.0%	4	16.0%	1	3.1%	0	0.0%	1	3.0%	2	1.7%	12	4.2%
女性	0	0.0%	2	14.3%	1	4.5%	1	3.7%	3	8.1%	2	6.3%	0	0.0%	7	5.4%	16	5.4%
男女合計	0	0.0%	4	14.8%	3	7.1%	5	9.6%	4	5.8%	2	3.0%	1	1.5%	9	3.6%	28	4.8%
4と回答																		
男性	0	0.0%	0	0.0%	1	5.0%	0	0.0%	3	9.4%	3	8.6%	0	0.0%	4	3.4%	11	3.8%
女性	1	20.0%	0	0.0%	0	0.0%	0	0.0%	2	5.4%	2	6.3%	0	0.0%	4	3.1%	9	3.0%
男女合計	1	5.9%	0	0.0%	1	2.4%	0	0.0%	5	7.2%	5	7.5%	0	0.0%	8	3.2%	20	3.4%
5と回答																		
男性	8	66.7%	8	61.5%	6	30.0%	4	16.0%	5	15.6%	13	37.1%	10	30.3%	22	18.5%	76	26.3%
女性	2	40.0%	5	35.7%	4	18.2%	9	33.3%	8	21.6%	10	31.3%	5	15.6%	31	23.8%	74	24.7%
男女合計	10	58.8%	13	48.1%	10	23.8%	13	25.0%	13	18.8%	23	34.3%	15	23.1%	53	21.3%	150	25.5%
無回答																		
男性	0	0.0%	0	0.0%	2	10.0%	2	8.0%	3	9.4%	3	8.6%	0	0.0%	14	11.8%	24	8.3%
女性	0	0.0%	1	7.1%	0	0.0%	1	3.7%	2	5.4%	0	0.0%	4	12.5%	21	16.2%	29	9.7%
男女合計	0	0.0%	1	3.7%	2	4.8%	3	5.8%	5	7.2%	3	4.5%	4	6.2%	35	14.1%	53	9.0%
全体(人)																		
男性	12		13		20		25		32		35		33		119		289	
女性	5		14		22		27		37		32		32		130		299	
男女合計	17		27		42		52		69		67		65		249		588	

南 会 津

	10	割合	20	割合	30	割合	40	割合	50	割合	64	割合	69	割合	70～	割合	全体数	割合
1と回答																		
男性	1	50.0%	0	0.0%	0	0.0%	1	33.3%	1	33.3%	3	100.0%	2	50.0%	17	85.0%	25	65.8%
女性	1	33.3%	0	0.0%	0	0.0%	2	40.0%	2	66.7%	2	100.0%	3	50.0%	11	73.3%	21	60.0%
男女合計	2	40.0%	0	0.0%	0	0.0%	3	37.5%	3	50.0%	5	100.0%	5	50.0%	28	80.0%	46	63.0%
2と回答																		
男性	0	0.0%	1	50.0%	0	0.0%	0	0.0%	0	0.0%	0	0.0%	0	0.0%	1	5.0%	2	5.3%
女性	0	0.0%	0	0.0%	0	0.0%	0	0.0%	0	0.0%	0	0.0%	0	0.0%	0	0.0%	0	0.0%
男女合計	0	0.0%	1	50.0%	0	0.0%	0	0.0%	0	0.0%	0	0.0%	0	0.0%	1	2.9%	2	2.7%
3と回答																		
男性	0	0.0%	1	50.0%	1	100.0%	0	0.0%	1	33.3%	0	0.0%	1	25.0%	1	5.0%	5	13.2%
女性	1	33.3%	0	0.0%	0	0.0%	1	20.0%	1	33.3%	0	0.0%	1	16.7%	2	13.3%	6	17.1%
男女合計	1	20.0%	1	50.0%	1	50.0%	1	12.5%	2	33.3%	0	0.0%	2	20.0%	3	8.6%	11	15.1%
4と回答																		
男性	0	0.0%	0	0.0%	0	0.0%	1	33.3%	0	0.0%	0	0.0%	0	0.0%	0	0.0%	1	2.6%
女性	0	0.0%	0	0.0%	0	0.0%	0	0.0%	0	0.0%	0	0.0%	0	0.0%	0	0.0%	0	0.0%
男女合計	0	0.0%	0	0.0%	0	0.0%	1	12.5%	0	0.0%	0	0.0%	0	0.0%	0	0.0%	1	1.4%
5と回答																		
男性	1	50.0%	0	0.0%	0	0.0%	1	33.3%	1	33.3%	0	0.0%	1	25.0%	1	5.0%	5	13.2%
女性	1	33.3%	0	0.0%	0	0.0%	2	40.0%	0	0.0%	0	0.0%	2	33.3%	1	6.7%	6	17.1%
男女合計	2	40.0%	0	0.0%	0	0.0%	3	37.5%	1	16.7%	0	0.0%	3	30.0%	2	5.7%	11	15.1%
無回答																		
男性	0	0.0%	0	0.0%	0	0.0%	0	0.0%	0	0.0%	0	0.0%	0	0.0%	0	0.0%	0	0.0%
女性	0	0.0%	0	0.0%	1	100.0%	0	0.0%	0	0.0%	0	0.0%	0	0.0%	1	6.7%	2	5.7%
男女合計	0	0.0%	0	0.0%	1	50.0%	0	0.0%	0	0.0%	0	0.0%	0	0.0%	1	2.9%	2	2.7%
全体(人)																		
男性	2		2		1		3		3		3		4		20		38	
女性	3		0		1		5		3		2		6		15		35	
男女合計	5		2		2		8		6		5		10		35		73	

相 双

	10	割合	20	割合	30	割合	40	割合	50	割合	64	割合	69	割合	70～	割合	全体数	割合
1と回答																		
男性	1	25.0%	1	11.1%	5	50.0%	0	0.0%	5	41.7%	8	61.5%	18	72.0%	27	69.2%	65	54.2%
女性	1	100.0%	1	20.0%	4	50.0%	6	54.5%	13	61.9%	11	73.3%	19	82.6%	30	62.5%	85	64.4%
男女合計	2	40.0%	2	14.3%	9	50.0%	6	31.6%	18	54.5%	19	67.9%	37	77.1%	57	65.5%	150	59.5%
2と回答																		
男性	0	0.0%	0	0.0%	0	0.0%	3	37.5%	0	0.0%	1	7.7%	1	4.0%	4	10.3%	9	7.5%
女性	0	0.0%	0	0.0%	1	12.5%	2	18.2%	0	0.0%	1	6.7%	1	4.3%	2	4.2%	7	5.3%
男女合計	0	0.0%	0	0.0%	1	5.6%	5	26.3%	0	0.0%	2	7.1%	2	4.2%	6	6.9%	16	6.3%
3と回答																		
男性	0	0.0%	1	11.1%	1	10.0%	0	0.0%	0	0.0%	0	0.0%	0	0.0%	1	2.6%	3	2.5%
女性	0	0.0%	2	40.0%	1	12.5%	0	0.0%	1	4.8%	2	13.3%	1	4.3%	1	2.1%	8	6.1%
男女合計	0	0.0%	3	21.4%	2	11.1%	0	0.0%	1	3.0%	2	7.1%	1	2.1%	2	2.3%	11	4.4%
4と回答																		
男性	0	0.0%	1	11.1%	0	0.0%	1	12.5%	4	33.3%	0	0.0%	2	8.0%	0	0.0%	8	6.7%
女性	0	0.0%	1	20.0%	0	0.0%	2	18.2%	2	9.5%	0	0.0%	0	0.0%	2	4.2%	7	5.3%
男女合計	0	0.0%	2	14.3%	0	0.0%	3	15.8%	6	18.2%	0	0.0%	2	4.2%	2	2.3%	15	6.0%
5と回答																		
男性	3	75.0%	6	66.7%	3	30.0%	2	25.0%	3	25.0%	3	23.1%	3	12.0%	5	12.8%	28	23.3%
女性	0	0.0%	1	20.0%	2	25.0%	0	0.0%	4	19.0%	1	6.7%	2	8.7%	10	20.8%	20	15.2%
男女合計	3	60.0%	7	50.0%	5	27.8%	2	10.5%	7	21.2%	4	14.3%	5	10.4%	15	17.2%	48	19.0%
無回答																		
男性	0	0.0%	0	0.0%	1	10.0%	2	25.0%	0	0.0%	1	7.7%	1	4.0%	2	5.1%	7	5.8%
女性	0	0.0%	0	0.0%	0	0.0%	1	9.1%	1	4.8%	0	0.0%	0	0.0%	3	6.3%	5	3.8%
男女合計	0	0.0%	0	0.0%	1	5.6%	3	15.8%	1	3.0%								

いわき

	10	割合	20	割合	30	割合	40	割合	50	割合	64	割合	69	割合	70～	割合	全体数	割合
1と回答																		
男性	5	41.7%	3	14.3%	14	27.5%	15	27.8%	15	30.6%	12	48.0%	19	51.4%	72	72.7%	155	44.5%
女性	4	36.4%	6	27.3%	21	52.5%	28	51.9%	24	42.1%	14	43.8%	23	63.9%	56	46.3%	176	47.2%
男女合計	9	39.1%	9	20.9%	35	38.5%	43	39.8%	39	36.8%	26	45.6%	42	57.5%	128	58.2%	331	45.9%
2と回答																		
男性	1	8.3%	1	4.8%	4	7.8%	5	9.3%	3	6.1%	2	8.0%	2	5.4%	5	5.1%	23	6.6%
女性	0	0.0%	0	0.0%	0	0.0%	2	3.7%	1	1.8%	3	9.4%	2	5.6%	6	5.0%	14	3.8%
男女合計	1	4.3%	1	2.3%	4	4.4%	7	6.5%	4	3.8%	5	8.8%	4	5.5%	11	5.0%	37	5.1%
3と回答																		
男性	2	16.7%	5	23.8%	2	3.9%	4	7.4%	5	10.2%	1	4.0%	3	8.1%	0	0.0%	22	6.3%
女性	1	9.1%	1	4.5%	2	5.0%	9	16.7%	6	10.5%	1	3.1%	0	0.0%	4	3.3%	24	6.4%
男女合計	3	13.0%	6	14.0%	4	4.4%	13	12.0%	11	10.4%	2	3.5%	3	4.1%	4	1.8%	46	6.4%
4と回答																		
男性	0	0.0%	2	9.5%	10	19.6%	8	14.8%	2	4.1%	4	16.0%	0	0.0%	1	1.0%	27	7.8%
女性	0	0.0%	4	18.2%	4	10.0%	3	5.6%	4	7.0%	4	12.5%	1	2.8%	5	4.1%	25	6.7%
男女合計	0	0.0%	6	14.0%	14	15.4%	11	10.2%	6	5.7%	8	14.0%	1	1.4%	6	2.7%	52	7.2%
5と回答																		
男性	4	33.3%	9	42.9%	19	37.3%	20	37.0%	21	42.9%	5	20.0%	13	35.1%	15	15.2%	106	30.5%
女性	5	45.5%	9	40.9%	11	27.5%	9	16.7%	21	36.8%	8	25.0%	8	22.2%	33	27.3%	104	27.9%
男女合計	9	39.1%	18	41.9%	30	33.0%	29	26.9%	42	39.6%	13	22.8%	21	28.8%	48	21.8%	210	29.1%
無回答																		
男性	0	0.0%	1	4.8%	2	3.9%	2	3.7%	3	6.1%	1	4.0%	0	0.0%	6	6.1%	15	4.3%
女性	1	9.1%	2	9.1%	2	5.0%	3	5.6%	1	1.8%	2	6.3%	2	5.6%	17	14.0%	30	8.0%
男女合計	1	4.3%	3	7.0%	4	4.4%	5	4.6%	4	3.8%	3	5.3%	2	2.7%	23	10.5%	45	6.2%
全体(人)																		
男性	12		21		51		54		49		25		37		99		348	
女性	11		22		40		54		57		32		36		121		373	
男女合計	23		43		91		108		106		57		73		220		721	

全県 (60歳以上・再掲)

	64	割合	69	割合	70	割合	80	割合	90	割合	全体数	割合
1と回答												
男性	109	55.3%	156	63.7%	295	74.1%	148	72.9%	9	50.0%	717	67.6%
女性	115	56.7%	176	69.0%	218	59.2%	125	50.2%	26	49.1%	660	58.5%
男女合計	224	56.0%	332	66.4%	513	67.0%	273	60.4%	35	49.3%	1377	62.9%
2と回答												
男性	6	3.0%	8	3.3%	15	3.8%	7	3.4%	0	0.0%	36	3.4%
女性	12	5.9%	6	2.4%	8	2.2%	5	2.0%	1	1.9%	32	2.8%
男女合計	18	4.5%	14	2.8%	23	3.0%	12	2.7%	1	1.4%	68	3.1%
3と回答												
男性	10	5.1%	14	5.7%	8	2.0%	5	2.5%	1	5.6%	38	3.6%
女性	12	5.9%	10	3.9%	12	3.3%	6	2.4%	2	3.8%	42	3.7%
男女合計	22	5.5%	24	4.8%	20	2.6%	11	2.4%	3	4.2%	80	3.7%
4と回答												
男性	15	7.6%	8	3.3%	4	1.0%	3	1.5%	0	0.0%	30	2.8%
女性	14	6.9%	3	1.2%	14	3.8%	5	2.0%	2	3.8%	38	3.4%
男女合計	29	7.3%	11	2.2%	18	2.3%	8	1.8%	2	2.8%	68	3.1%
5と回答												
男性	47	23.9%	49	20.0%	56	14.1%	26	12.8%	6	33.3%	184	17.3%
女性	43	21.2%	47	18.4%	80	21.7%	69	27.7%	14	26.4%	253	22.4%
男女合計	90	22.5%	96	19.2%	136	17.8%	95	21.0%	20	28.2%	437	20.0%
無回答												
男性	10	5.1%	10	4.1%	20	5.0%	14	6.9%	2	11.1%	56	5.3%
女性	7	3.4%	13	5.1%	36	9.8%	39	15.7%	8	15.1%	103	9.1%
男女合計	17	4.3%	23	4.6%	56	7.3%	53	11.7%	10	14.1%	159	7.3%
全体(人)												
男性	197		245		398		203		18		1061	
女性	203		255		368		249		53		1128	
男女合計	400		500		766		452		71		2189	

6 食生活（朝食・夕食）の状況（満15歳以上対象）（調査票 問6）

問6 あなたは、夕食を家族とどのくらい一緒に食べていますか。

- 1 ほとんど毎日 2 週に4～5日 3 週に2～3日
4 週に1日程度 5 ほとんどない

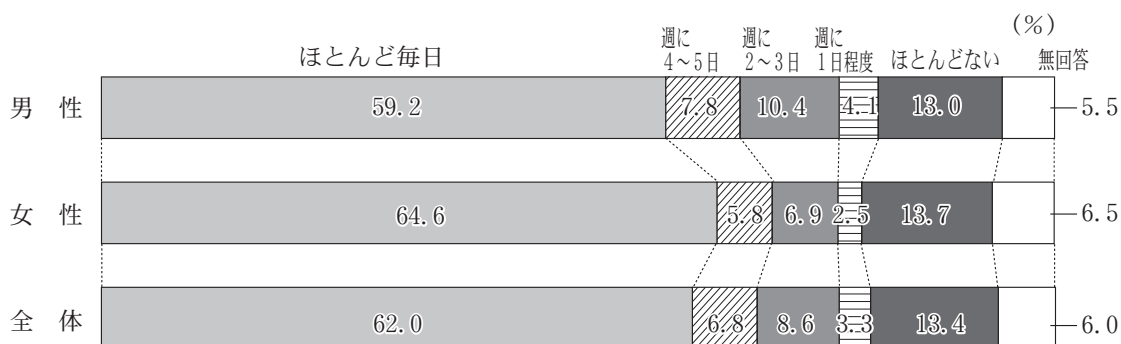

	10	割合	20	割合	30	割合	40	割合	50	割合	64	割合	69	割合	70	割合	80	割合	90	割合	全体数	割合
1と回答																						
男性	49	64.5%	48	40.0%	77	37.4%	105	41.5%	131	48.2%	132	67.0%	170	69.4%	305	76.6%	151	74.4%	9	50.0%	1177	59.2%
女性	44	64.7%	66	54.1%	120	69.4%	175	68.4%	195	58.9%	147	72.4%	199	78.0%	235	63.9%	133	53.4%	29	54.7%	1343	64.6%
男女合計	93	64.6%	114	47.1%	197	52.0%	280	55.0%	326	54.1%	279	69.8%	369	73.8%	540	70.5%	284	62.8%	38	53.5%	2520	62.0%
2と回答																						
男性	7	9.2%	9	7.5%	34	16.5%	32	12.6%	31	11.4%	9	4.6%	17	6.9%	9	2.3%	7	3.4%	0	0.0%	155	7.8%
女性	4	5.9%	14	11.5%	14	8.1%	26	10.2%	27	8.2%	12	5.9%	7	2.7%	9	2.4%	7	2.8%	1	1.9%	121	5.8%
男女合計	11	7.6%	23	9.5%	48	12.7%	58	11.4%	58	9.6%	21	5.3%	24	4.8%	18	2.3%	14	3.1%	1	1.4%	276	6.8%
3と回答																						
男性	4	5.3%	17	14.2%	51	24.8%	56	22.1%	40	14.7%	12	6.1%	8	3.3%	11	2.8%	6	3.0%	1	5.6%	206	10.4%
女性	5	7.4%	12	9.8%	15	8.7%	21	8.2%	38	11.5%	10	4.9%	12	4.7%	18	4.9%	9	3.6%	3	5.7%	143	6.9%
男女合計	9	6.3%	29	12.0%	66	17.4%	77	15.1%	78	12.9%	22	5.5%	20	4.0%	29	3.8%	15	3.3%	4	5.6%	349	8.6%
4と回答																						
男性	3	3.9%	9	7.5%	10	4.9%	20	7.9%	15	5.5%	4	2.0%	8	3.3%	9	2.3%	3	1.5%	1	5.6%	82	4.1%
女性	2	2.9%	6	4.9%	6	3.5%	8	3.1%	9	2.7%	4	2.0%	3	1.2%	8	2.2%	5	2.0%	1	1.9%	52	2.5%
男女合計	5	3.5%	15	6.2%	16	4.2%	28	5.5%	24	4.0%	8	2.0%	11	2.2%	17	2.2%	8	1.8%	2	2.8%	134	3.3%
5と回答																						
男性	9	11.8%	30	25.0%	25	12.1%	31	12.3%	43	15.8%	29	14.7%	31	12.7%	38	9.5%	20	9.9%	3	16.7%	259	13.0%
女性	11	16.2%	17	13.9%	10	5.8%	17	6.6%	49	14.8%	23	11.3%	20	7.8%	71	19.3%	57	22.9%	9	17.0%	284	13.7%
男女合計	20	13.9%	47	19.4%	35	9.2%	48	9.4%	92	15.3%	52	13.0%	51	10.2%	109	14.2%	77	17.0%	12	16.9%	543	13.4%
無回答																						
男性	4	5.3%	7	5.8%	9	4.4%	9	3.6%	12	4.4%	11	5.6%	11	4.5%	26	6.5%	16	7.9%	4	22.2%	109	5.5%
女性	2	2.9%	7	5.7%	8	4.6%	9	3.5%	13	3.9%	7	3.4%	14	5.5%	27	7.3%	38	15.3%	10	18.9%	135	6.5%
男女合計	6	4.2%	14	5.8%	17	4.5%	18	3.5%	25	4.1%	18	4.5%	25	5.0%	53	6.9%	54	11.9%	14	19.7%	244	6.0%
全体(人)																						
男性	76		120		206		253		272		197		245		398		203		18	1988		
女性	68		122		173		256		331		203		255		368		249		53	2078		
男女合計	144		242		379		509		603		400		500		766		452		71	4066		

県 北

	10	割合	20	割合	30	割合	40	割合	50	割合	64	割合	69	割合	70～	割合	全体数	割合
1と回答																		
男性	24	82.8%	15	39.5%	16	27.6%	28	39.4%	46	58.2%	35	62.5%	49	76.6%	131	77.1%	344	60.9%
女性	19	82.6%	23	51.1%	27	60.0%	50	73.5%	63	63.0%	36	72.0%	51	77.3%	106	58.6%	375	64.9%
男女合計	43	82.7%	38	45.8%	43	41.7%	78	56.1%	109	60.9%	71	67.0%	100	76.9%	237	67.5%	719	62.9%
2と回答																		
男性	1	3.4%	2	5.3%	11	19.0%	8	11.3%	5	6.3%	3	5.4%	2	3.1%	4	2.4%	36	6.4%
女性	1	4.3%	5	11.1%	3	6.7%	6	8.8%	10	10.0%	1	2.0%	2	3.0%	1	0.6%	29	5.0%
男女合計	2	3.8%	7	8.4%	14	13.6%	14	10.1%	15	8.4%	4	3.8%	4	3.1%	5	1.4%	65	5.7%
3と回答																		
男性	0	0.0%	6	15.8%	16	27.6%	21	29.6%	12	15.2%	5	8.9%	4	6.3%	5	2.9%	69	12.2%
女性	1	4.3%	5	11.1%	6	13.3%	5	7.4%	11	11.0%	3	6.0%	3	4.5%	6	3.3%	40	6.9%
男女合計	1	1.9%	11	13.3%	22	21.4%	26	18.7%	23	12.8%	8	7.5%	7	5.4%	11	3.1%	109	9.5%
4と回答																		
男性	0	0.0%	3	7.9%	5	8.6%	5	7.0%	2	2.5%	1	1.8%	2	3.1%	3	1.8%	21	3.7%
女性	0	0.0%	2	4.4%	3	6.7%	1	1.5%	1	1.0%	0	0.0%	1	1.5%	5	2.8%	13	2.2%
男女合計	0	0.0%	5	6.0%	8	7.8%	6	4.3%	3	1.7%	1	0.9%	3	2.3%	8	2.3%	34	3.0%
5と回答																		
男性	1	3.4%	8	21.1%	8	13.8%	4	5.6%	11	13.9%	8	14.3%	4	6.3%	18	10.6%	62	11.0%
女性	1	4.3%	7	15.6%	2	4.4%	3	4.4%	11	11.0%	7	14.0%	6	9.1%	42	23.2%	79	13.7%
男女合計	2	3.8%	15	18.1%	10	9.7%	7	5.0%	22	12.3%	15	14.2%	10	7.7%	60	17.1%	141	12.3%
無回答																		
男性	3	10.3%	4	10.5%	2	3.4%	5	7.0%	3	3.8%	4	7.1%	3	4.7%	9	5.3%	33	5.8%
女性	1	4.3%	3	6.7%	4	8.9%	3	4.4%	4	4.0%	3	6.0%	3	4.5%	21	11.6%	42	7.3%
男女合計	4	7.7%	7	8.4%	6	5.8%	8	5.8%	7	3.9%	7	6.6%	6	4.6%	30	8.5%	75	6.6%
全体(人)																		
男性	29		38		58		71		79		56		64		170		565	
女性	23		45		45		68		100		50		66		181		578	
男女合計	52		83		103		139		179		106		130		351		1143	

県 中

	10	割合	20	割合	30	割合	40	割合	50	割合	64	割合	69	割合	70～	割合	全体数	割合
1と回答																		
男性	10	62.5%	12	50.0%	23	42.6%	30	42.3%	26	38.2%	30	68.2%	37	64.9%	84	76.4%	252	56.8%
女性	12	57.1%	20	62.5%	32	68.1%	48	68.6%	43	50.6%	37	78.7%	49	74.2%	57	53.8%	298	62.9%
男女合計	22	59.5%	32	57.1%	55	54.5%	78	55.3%	69	45.1%	67	73.6%	86	69.9%	141	65.3%	550	59.9%
2と回答																		
男性	3	18.8%	2	8.3%	11	20.4%	8	11.3%	14	20.6%	3	6.8%	6	10.5%	3	2.7%	50	11.3%
女性	1	4.8%	5	15.6%	3	6.4%	8	11.4%	7	8.2%	2	4.3%	3	4.5%	3	2.8%	32	6.8%
男女合計	4	10.8%	7	12.5%	14	13.9%	16	11.3%	21	13.7%	5	5.5%	9	7.3%	6	2.8%	82	8.9%
3と回答																		
男性	1	6.3%	0	0.0%	12	22.2%	19	26.8%	5	7.4%	2	4.5%	1	1.8%	2	1.8%	42	9.5%
女性	3	14.3%	2	6.3%	3	6.4%	5	7.1%	8	9.4%	3	6.4%	4	6.1%	6	5.7%	34	7.2%
男女合計	4	10.8%	2	3.6%	15	14.9%	24	17.0%	13	8.5%	5	5.5%	5	4.1%	8	3.7%	76	8.3%
4と回答																		
男性	1	6.3%	2	8.3%	1	1.9%	6	8.5%	6	8.8%	1	2.3%	2	3.5%	2	1.8%	21	4.7%
女性	1	4.8%	1	3.1%	2	4.3%	5	7.1%	5	5.9%	0	0.0%	1	1.5%	1	0.9%	16	3.4%
男女合計	2	5.4%	3	5.4%	3	3.0%	11	7.8%	11	7.2%	1	1.1%	3	2.4%	3	1.4%	37	4.0%
5と回答																		
男性	0	0.0%	7	29.2%	6	11.1%	8	11.3%	14	20.6%	7	15.9%	7	12.3%	10	9.1%	59	13.3%
女性	4	19.0%	4	12.5%	5	10.6%	4	5.7%	19	22.4%	5	10.6%	6	9.1%	27	25.5%	74	15.6%
男女合計	4	10.8%	11	19.6%	11	10.9%	12	8.5%	33	21.6%	12	13.2%	13	10.6%	37	17.1%	133	14.5%
無回答																		
男性	1	6.3%	1	4.2%	1	1.9%	0	0.0%	3	4.4%	1	2.3%	4	7.0%	9	8.2%	20	4.5%
女性	0	0.0%	0	0.0%	2	4.3%	0	0.0%	3	3.5%	0	0.0%	3	4.5%	12	11.3%	20	4.2%
男女合計	1	2.7%	1	1.8%	3	3.0%	0	0.0%	6	3.9%	1	1.1%	7	5.7%	21	9.7%	40	4.4%
全体(人)																		
男性	16		24		54		71		68		44		57		110		444	
女性	21		32		47		70		85		47		66		106		474	
男女合計	37		56		101		141		153		91		123		216		918	

県 南

	10	割合	20	割合	30	割合	40	割合	50	割合	64	割合	69	割合	70～	割合	全体数	割合
1と回答																		
男性	0	0.0%	4	30.8%	3	25.0%	7	33.3%	15	51.7%	16	76.2%	16	64.0%	50	80.6%	111	60.3%
女性	2	50.0%	2	50.0%	7	70.0%	11	52.4%	12	42.9%	19	76.0%	23	88.5%	52	75.4%	128	68.4%
男女合計	2	40.0%	6	35.3%	10	45.5%	18	42.9%	27	47.4%	35	76.1%	39	76.5%	102	77.9%	239	64.4%
2と回答																		
男性	0	0.0%	0	0.0%	0	0.0%	2	9.5%	4	13.8%	1	4.8%	2	8.0%	3	4.8%	12	6.5%
女性	0	0.0%	1	25.0%	2	20.0%	1	4.8%	4	14.3%	1	4.0%	0	0.0%	2	2.9%	11	5.9%
男女合計	0	0.0%	1	5.9%	2	9.1%	3	7.1%	8	14.0%	2	4.3%	2	3.9%	5	3.8%	23	6.2%
3と回答																		
男性	1	100.0%	1	7.7%	4	33.3%	4	19.0%	3	10.3%	2	9.5%	0	0.0%	3	4.8%	18	9.8%
女性	0	0.0%	0	0.0%	0	0.0%	2	9.5%	5	17.9%	0	0.0%	1	3.8%	2	2.9%	10	5.3%
男女合計	1	20.0%	1	5.9%	4	18.2%	6	14.3%	8	14.0%	2	4.3%	1	2.0%	5	3.8%	28	7.5%
4と回答																		
男性	0	0.0%	2	15.4%	0	0.0%	4	19.0%	1	3.4%	1	4.8%	1	4.0%	1	1.6%	10	5.4%
女性	1	25.0%	0	0.0%	0	0.0%	1	4.8%	0	0.0%	1	4.0%	0	0.0%	1	1.4%	4	2.1%
男女合計	1	20.0%	2	11.8%	0	0.0%	5	11.9%	1	1.8%	2	4.3%	1	2.0%	2	1.5%	14	3.8%
5と回答																		
男性	0	0.0%	6	46.2%	3	25.0%	4	19.0%	5	17.2%	1	4.8%	4	16.0%	2	3.2%	25	13.6%
女性	1	25.0%	1	25.0%	1	10.0%	4	19.0%	5	17.9%	3	12.0%	1	3.8%	6	8.7%	22	11.8%
男女合計	1	20.0%	7	41.2%	4	18.2%	8	19.0%	10	17.5%	4	8.7%	5	9.8%	8	6.1%	47	12.7%
無回答																		
男性	0	0.0%	0	0.0%	2	16.7%	0	0.0%	1	3.4%	0	0.0%	2	8.0%	3	4.8%	8	4.3%
女性	0	0.0%	0	0.0%	0	0.0%	2	9.5%	2	7.1%	1	4.0%	1	3.8%				

会 津

	10	割合	20	割合	30	割合	40	割合	50	割合	64	割合	69	割合	70～	割合	全体数	割合
1と回答																		
男性	5	41.7%	6	46.2%	9	45.0%	14	56.0%	14	43.8%	17	48.6%	25	75.8%	78	65.5%	168	58.1%
女性	3	60.0%	6	42.9%	18	81.8%	20	74.1%	26	70.3%	20	62.5%	25	78.1%	75	57.7%	193	64.5%
男女合計	8	47.1%	12	44.4%	27	64.3%	34	65.4%	40	58.0%	37	55.2%	50	76.9%	153	61.4%	361	61.4%
2と回答																		
男性	1	8.3%	3	23.1%	3	15.0%	3	12.0%	3	9.4%	1	2.9%	1	3.0%	3	2.5%	18	6.2%
女性	0	0.0%	0	0.0%	2	9.1%	0	0.0%	1	2.7%	4	12.5%	0	0.0%	4	3.1%	11	3.7%
男女合計	1	5.9%	3	11.1%	5	11.9%	3	5.8%	4	5.8%	5	7.5%	1	1.5%	7	2.8%	29	4.9%
3と回答																		
男性	1	8.3%	3	23.1%	5	25.0%	4	16.0%	7	21.9%	3	8.6%	1	3.0%	6	5.0%	30	10.4%
女性	0	0.0%	3	21.4%	1	4.5%	2	7.4%	3	8.1%	2	6.3%	1	3.1%	8	6.2%	20	6.7%
男女合計	1	5.9%	6	22.2%	6	14.3%	6	11.5%	10	14.5%	5	7.5%	2	3.1%	14	5.6%	50	8.5%
4と回答																		
男性	1	8.3%	0	0.0%	1	5.0%	0	0.0%	3	9.4%	1	2.9%	0	0.0%	4	3.4%	10	3.5%
女性	0	0.0%	2	14.3%	0	0.0%	0	0.0%	0	0.0%	1	3.1%	0	0.0%	4	3.1%	7	2.3%
男女合計	1	5.9%	2	7.4%	1	2.4%	0	0.0%	3	4.3%	2	3.0%	0	0.0%	8	3.2%	17	2.9%
5と回答																		
男性	4	33.3%	1	7.7%	0	0.0%	3	12.0%	3	9.4%	10	28.6%	6	18.2%	14	11.8%	41	14.2%
女性	2	40.0%	1	7.1%	1	4.5%	4	14.8%	4	10.8%	5	15.6%	2	6.3%	23	17.7%	42	14.0%
男女合計	6	35.3%	2	7.4%	1	2.4%	7	13.5%	7	10.1%	15	22.4%	8	12.3%	37	14.9%	83	14.1%
無回答																		
男性	0	0.0%	0	0.0%	2	10.0%	1	4.0%	2	6.3%	3	8.6%	0	0.0%	14	11.8%	22	7.6%
女性	0	0.0%	2	14.3%	0	0.0%	1	3.7%	3	8.1%	0	0.0%	4	12.5%	16	12.3%	26	8.7%
男女合計	0	0.0%	2	7.4%	2	4.8%	2	3.8%	5	7.2%	3	4.5%	4	6.2%	30	12.0%	48	8.2%
全体(人)																		
男性	12		13		20		25		32		35		33		119		289	
女性	5		14		22		27		37		32		32		130		299	
男女合計	17		27		42		52		69		67		65		249		588	

南 会 津

	10	割合	20	割合	30	割合	40	割合	50	割合	64	割合	69	割合	70～	割合	全体数	割合
1と回答																		
男性	1	50.0%	1	50.0%	0	0.0%	2	66.7%	1	33.3%	3	100.0%	2	50.0%	17	85.0%	27	71.1%
女性	2	66.7%	0	0.0%	1	100.0%	3	60.0%	2	66.7%	2	100.0%	3	50.0%	10	66.7%	23	65.7%
男女合計	3	60.0%	1	50.0%	1	50.0%	5	62.5%	3	50.0%	5	100.0%	5	50.0%	27	77.1%	50	68.5%
2と回答																		
男性	0	0.0%	0	0.0%	0	0.0%	1	33.3%	1	33.3%	0	0.0%	0	0.0%	0	0.0%	2	5.3%
女性	0	0.0%	0	0.0%	0	0.0%	1	20.0%	0	0.0%	0	0.0%	0	0.0%	0	0.0%	1	2.9%
男女合計	0	0.0%	0	0.0%	0	0.0%	2	25.0%	1	16.7%	0	0.0%	0	0.0%	0	0.0%	3	4.1%
3と回答																		
男性	0	0.0%	1	50.0%	1	100.0%	0	0.0%	0	0.0%	0	0.0%	1	25.0%	0	0.0%	3	7.9%
女性	1	33.3%	0	0.0%	0	0.0%	1	20.0%	1	33.3%	0	0.0%	2	33.3%	1	6.7%	6	17.1%
男女合計	1	20.0%	1	50.0%	1	50.0%	1	12.5%	1	16.7%	0	0.0%	3	30.0%	1	2.9%	9	12.3%
4と回答																		
男性	0	0.0%	0	0.0%	0	0.0%	0	0.0%	0	0.0%	0	0.0%	0	0.0%	1	5.0%	1	2.6%
女性	0	0.0%	0	0.0%	0	0.0%	0	0.0%	0	0.0%	0	0.0%	0	0.0%	0	0.0%	0	0.0%
男女合計	0	0.0%	0	0.0%	0	0.0%	0	0.0%	0	0.0%	0	0.0%	0	0.0%	1	2.9%	1	1.4%
5と回答																		
男性	1	50.0%	0	0.0%	0	0.0%	0	0.0%	1	33.3%	0	0.0%	1	25.0%	0	0.0%	3	7.9%
女性	0	0.0%	0	0.0%	0	0.0%	0	0.0%	0	0.0%	0	0.0%	1	16.7%	1	6.7%	2	5.7%
男女合計	1	20.0%	0	0.0%	0	0.0%	0	0.0%	1	16.7%	0	0.0%	2	20.0%	1	2.9%	5	6.8%
無回答																		
男性	0	0.0%	0	0.0%	0	0.0%	0	0.0%	0	0.0%	0	0.0%	0	0.0%	2	10.0%	2	5.3%
女性	0	0.0%	0	0.0%	0	0.0%	0	0.0%	0	0.0%	0	0.0%	0	0.0%	3	20.0%	3	8.6%
男女合計	0	0.0%	0	0.0%	0	0.0%	0	0.0%	0	0.0%	0	0.0%	0	0.0%	5	14.3%	5	6.8%
全体(人)																		
男性	2		2		1		3		3		3		4		20		38	
女性	3		0		1		5		3		2		6		15		35	
男女合計	5		2		2		8		6		5		10		35		73	

相 双

	10	割合	20	割合	30	割合	40	割合	50	割合	64	割合	69	割合	70～	割合	全体数	割合
1と回答																		
男性	2	50.0%	4	44.4%	4	40.0%	2	25.0%	11	91.7%	11	84.6%	18	72.0%	31	79.5%	83	69.2%
女性	1	100.0%	4	80.0%	5	62.5%	9	81.8%	17	81.0%	12	80.0%	22	95.7%	34	70.8%	104	78.8%
男女合計	3	60.0%	8	57.1%	9	50.0%	11	57.9%	28	84.8%	23	82.1%	40	83.3%	65	74.7%	187	74.2%
2と回答																		
男性	0	0.0%	0	0.0%	2	20.0%	2	25.0%	0	0.0%	0	0.0%	3	12.0%	1	2.6%	8	6.7%
女性	0	0.0%	0	0.0%	1	12.5%	1	9.1%	1	4.8%	1	6.7%	0	0.0%	2	4.2%	6	4.5%
男女合計	0	0.0%	0	0.0%	3	16.7%	3	15.8%	1	3.0%	1	3.6%	3	6.3%	3	3.4%	14	5.6%
3と回答																		
男性	0	0.0%	1	11.1%	1	10.0%	0	0.0%	0	0.0%	0	0.0%	0	0.0%	1	2.6%	3	2.5%
女性	0	0.0%	0	0.0%	1	12.5%	0	0.0%	3	14.3%	1	6.7%	0	0.0%	0	0.0%	5	3.8%
男女合計	0	0.0%	1	7.1%	2	11.1%	0	0.0%	3	9.1%	1	3.6%	0	0.0%	1	1.1%	8	3.2%
4と回答																		
男性	0	0.0%	1	11.1%	0	0.0%	0	0.0%	1	8.3%	0	0.0%	2	8.0%	0	0.0%	4	3.3%
女性	0	0.0%	0	0.0%	0	0.0%	0	0.0%	0	0.0%	1	6.7%	0	0.0%	1	2.1%	2	1.5%
男女合計	0	0.0%	1	7.1%	0	0.0%	0	0.0%	1	3.0%	1	3.6%	2	4.2%	1	1.1%	6	2.4%
5と回答																		
男性	2	50.0%	3	33.3%	2	20.0%	2	25.0%	0	0.0%	1	7.7%	1	4.0%	4	10.3%	15	12.5%
女性	0	0.0%	1	20.0%	1	12.5%	0	0.0%	0	0.0%	0	0.0%	1	4.3%	10	20.8%	13	9.8%
男女合計	2	40.0%	4	28.6%	3	16.7%	2	10.5%	0	0.0%	1	3.6%	2	4.2%	14	16.1%	28	11.1%
無回答																		
男性	0	0.0%	0	0.0%	1	10.0%	2	25.0%	0	0.0%	1	7.7%	1	4.0%	2	5.1%	7	5.8%
女性	0	0.0%	0	0.0%	0	0.0%	1	9.1%	0	0.0%	0	0.0%	0	0.0%	1	2.1%	2	1.5%
男女合計	0	0.0%	0	0.0%	1	5.6%	3	15.8%	0	0.0%	1	3.6%	1</					

いわき

	10	割合	20	割合	30	割合	40	割合	50	割合	64	割合	69	割合	70～	割合	全体数	割合
1と回答																		
男性	7	58.3%	6	28.6%	22	43.1%	22	40.7%	18	36.7%	20	80.0%	23	62.2%	74	74.7%	192	55.2%
女性	5	45.5%	11	50.0%	30	75.0%	34	63.0%	32	56.1%	21	65.6%	26	72.2%	63	52.1%	222	59.5%
男女合計	12	52.2%	17	39.5%	52	57.1%	56	51.9%	50	47.2%	41	71.9%	49	67.1%	137	62.3%	414	57.4%
2と回答																		
男性	2	16.7%	2	9.5%	7	13.7%	8	14.8%	4	8.2%	1	4.0%	3	8.1%	2	2.0%	29	8.3%
女性	2	18.2%	3	13.6%	3	7.5%	9	16.7%	4	7.0%	3	9.4%	2	5.6%	5	4.1%	31	8.3%
男女合計	4	17.4%	5	11.6%	10	11.0%	17	15.7%	8	7.5%	4	7.0%	5	6.8%	7	3.2%	60	8.3%
3と回答																		
男性	1	8.3%	5	23.8%	12	23.5%	8	14.8%	13	26.5%	0	0.0%	1	2.7%	1	1.0%	41	11.8%
女性	0	0.0%	2	9.1%	4	10.0%	6	11.1%	7	12.3%	1	3.1%	1	2.8%	7	5.8%	28	7.5%
男女合計	1	4.3%	7	16.3%	16	17.6%	14	13.0%	20	18.9%	1	1.8%	2	2.7%	8	3.6%	69	9.6%
4と回答																		
男性	1	8.3%	1	4.8%	3	5.9%	5	9.3%	2	4.1%	0	0.0%	1	2.7%	2	2.0%	15	4.3%
女性	0	0.0%	1	4.5%	1	2.5%	1	1.9%	3	5.3%	1	3.1%	1	2.8%	2	1.7%	10	2.7%
男女合計	1	4.3%	2	4.7%	4	4.4%	6	5.6%	5	4.7%	1	1.8%	2	2.7%	4	1.8%	25	3.5%
5と回答																		
男性	1	8.3%	5	23.8%	6	11.8%	10	18.5%	9	18.4%	2	8.0%	8	21.6%	13	13.1%	54	15.5%
女性	3	27.3%	3	13.6%	0	0.0%	2	3.7%	10	17.5%	3	9.4%	3	8.3%	28	23.1%	52	13.9%
男女合計	4	17.4%	8	18.6%	6	6.6%	12	11.1%	19	17.9%	5	8.8%	11	15.1%	41	18.6%	106	14.7%
無回答																		
男性	0	0.0%	2	9.5%	1	2.0%	1	1.9%	3	6.1%	2	8.0%	1	2.7%	7	7.1%	17	4.9%
女性	1	9.1%	2	9.1%	2	5.0%	2	3.7%	1	1.8%	3	9.4%	3	8.3%	16	13.2%	30	8.0%
男女合計	1	4.3%	4	9.3%	3	3.3%	3	2.8%	4	3.8%	5	8.8%	4	5.5%	23	10.5%	47	6.5%
全体(人)																		
男性	12		21		51		54		49		25		37		99		348	
女性	11		22		40		54		57		32		36		121		373	
男女合計	23		43		91		108		106		57		73		220		721	

全県 (60歳以上・再掲)

	64	割合	69	割合	70	割合	80	割合	90	割合	全体数	割合
1と回答												
男性	132	67.0%	170	69.4%	305	76.6%	151	74.4%	9	50.0%	767	72.3%
女性	147	72.4%	199	78.0%	235	63.9%	133	53.4%	29	54.7%	743	65.9%
男女合計	279	69.8%	369	73.8%	540	70.5%	284	62.8%	38	53.5%	1510	69.0%
2と回答												
男性	9	4.6%	17	6.9%	9	2.3%	7	3.4%	0	0.0%	42	4.0%
女性	12	5.9%	7	2.7%	9	2.4%	7	2.8%	1	1.9%	36	3.2%
男女合計	21	5.3%	24	4.8%	18	2.3%	14	3.1%	1	1.4%	78	3.6%
3と回答												
男性	12	6.1%	8	3.3%	11	2.8%	6	3.0%	1	5.6%	38	3.6%
女性	10	4.9%	12	4.7%	18	4.9%	9	3.6%	3	5.7%	52	4.6%
男女合計	22	5.5%	20	4.0%	29	3.8%	15	3.3%	4	5.6%	90	4.1%
4と回答												
男性	4	2.0%	8	3.3%	9	2.3%	3	1.5%	1	5.6%	25	2.4%
女性	4	2.0%	3	1.2%	8	2.2%	5	2.0%	1	1.9%	21	1.9%
男女合計	8	2.0%	11	2.2%	17	2.2%	8	1.8%	2	2.8%	46	2.1%
5と回答												
男性	29	14.7%	31	12.7%	38	9.5%	20	9.9%	3	16.7%	121	11.4%
女性	23	11.3%	20	7.8%	71	19.3%	57	22.9%	9	17.0%	180	16.0%
男女合計	52	13.0%	51	10.2%	109	14.2%	77	17.0%	12	16.9%	301	13.8%
無回答												
男性	0	0.0%	0	0.0%	0	0.0%	0	0.0%	0	0.0%	0	0.0%
女性	0	0.0%	0	0.0%	0	0.0%	0	0.0%	0	0.0%	0	0.0%
男女合計	0	0.0%	0	0.0%	0	0.0%	0	0.0%	0	0.0%	0	0.0%
全体(人)												
男性	197		245		398		203		18		1061	
女性	203		255		368		249		53		1128	
男女合計	400		500		766		452		71		2189	

7 「食育推進月間」「食育の日」の認知度（満15歳以上対象）（調査票 問7）

問7 あなたは、食育推進月間と食育の日を知っていますか。

- 1 知っている 2 名称は知っているが、月日までは知らなかった
3 知らない

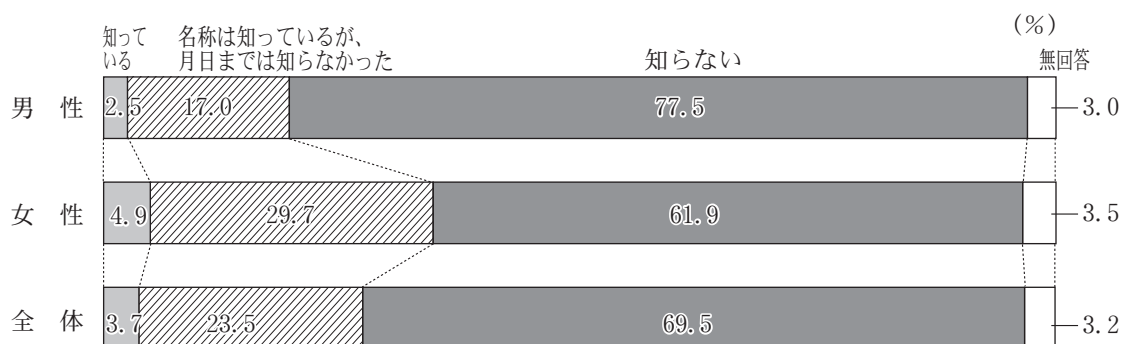

	10	割合	20	割合	30	割合	40	割合	50	割合	64	割合	69	割合	70	割合	80	割合	90	割合	全体数	割合
1と回答																						
男性	0	0.0%	3	2.5%	2	1.0%	6	2.4%	9	3.3%	4	2.0%	7	2.9%	9	2.3%	8	3.9%	2	11.1%	50	2.5%
女性	2	2.9%	8	6.6%	11	6.4%	12	4.7%	26	7.9%	9	4.4%	6	2.4%	19	5.2%	9	3.6%	0	0.0%	102	4.9%
男女合計	2	1.4%	11	4.5%	13	3.4%	18	3.5%	35	5.8%	13	3.3%	13	2.6%	28	3.7%	17	3.8%	2	2.8%	152	3.7%
2と回答																						
男性	13	17.1%	17	14.2%	37	18.0%	38	15.0%	42	15.4%	34	17.3%	35	14.3%	87	21.9%	31	15.3%	4	22.2%	338	17.0%
女性	16	23.5%	33	27.0%	50	28.9%	92	35.9%	93	28.1%	55	27.1%	87	34.1%	130	35.3%	58	23.3%	3	5.7%	617	29.7%
男女合計	29	20.1%	50	20.7%	87	23.0%	130	25.5%	135	22.4%	89	22.3%	122	24.4%	217	28.3%	89	19.7%	7	9.9%	955	23.5%
3と回答																						
男性	60	78.9%	97	80.8%	161	78.2%	201	79.4%	214	78.7%	154	78.2%	196	80.0%	293	73.6%	153	75.4%	11	61.1%	1540	77.5%
女性	48	70.6%	76	62.3%	110	63.6%	146	57.0%	204	61.6%	137	67.5%	154	60.4%	207	56.3%	161	64.7%	44	83.0%	1287	61.9%
男女合計	108	75.0%	173	71.5%	271	71.5%	347	68.2%	418	69.3%	291	72.8%	350	70.0%	500	65.3%	314	69.5%	55	77.5%	2827	69.5%
無回答																						
男性	3	3.9%	3	2.5%	6	2.9%	8	3.2%	7	2.6%	5	2.5%	7	2.9%	9	2.3%	11	5.4%	1	5.6%	60	3.0%
女性	2	2.9%	5	4.1%	2	1.2%	6	2.3%	8	2.4%	2	1.0%	8	3.1%	12	3.3%	21	8.4%	6	11.3%	72	3.5%
男女合計	5	3.5%	8	3.3%	8	2.1%	14	2.8%	15	2.5%	7	1.8%	15	3.0%	21	2.7%	32	7.1%	7	9.9%	132	3.2%
全体(人)																						
男性	76		120		206		253		272		197		245		398		203		18		1988	
女性	68		122		173		256		331		203		255		368		249		53		2078	
男女合計	144		242		379		509		603		400		500		766		452		71		4066	

県 北

	10	割合	20	割合	30	割合	40	割合	50	割合	64	割合	69	割合	70～	割合	全体数	割合
1と回答																		
男性	0	0.0%	0	0.0%	0	0.0%	2	2.8%	5	6.3%	1	1.8%	2	3.1%	2	1.2%	12	2.1%
女性	1	4.3%	3	6.7%	6	13.3%	3	4.4%	8	8.0%	1	2.0%	2	3.0%	7	3.9%	31	5.4%
男女合計	1	1.9%	3	3.6%	6	5.8%	5	3.6%	13	7.3%	2	1.9%	4	3.1%	9	2.6%	43	3.8%
2と回答																		
男性	2	6.9%	6	15.8%	14	24.1%	10	14.1%	10	12.7%	12	21.4%	8	12.5%	29	17.1%	91	16.1%
女性	6	26.1%	16	35.6%	9	20.0%	25	36.8%	27	27.0%	12	24.0%	23	34.8%	47	26.0%	165	28.5%
男女合計	8	15.4%	22	26.5%	23	22.3%	35	25.2%	37	20.7%	24	22.6%	31	23.8%	76	21.7%	256	22.4%
3と回答																		
男性	25	86.2%	30	78.9%	42	72.4%	55	77.5%	62	78.5%	42	75.0%	51	79.7%	133	78.2%	440	77.9%
女性	15	65.2%	24	53.3%	28	62.2%	37	54.4%	63	63.0%	36	72.0%	37	56.1%	118	65.2%	358	61.9%
男女合計	40	76.9%	54	65.1%	70	68.0%	92	66.2%	125	69.8%	78	73.6%	88	67.7%	251	71.5%	798	69.8%
無回答																		
男性	2	6.9%	2	5.3%	2	3.4%	4	5.6%	2	2.5%	1	1.8%	3	4.7%	6	3.5%	22	3.9%
女性	1	4.3%	2	4.4%	2	4.4%	3	4.4%	2	2.0%	1	2.0%	4	6.1%	9	5.0%	24	4.2%
男女合計	3	5.8%	4	4.8%	4	3.9%	7	5.0%	4	2.2%	2	1.9%	7	5.4%	15	4.3%	46	4.0%
全体(人)																		
男性	29		38		58		71		79		56		64		170		565	
女性	23		45		45		68		100		50		66		181		578	
男女合計	52		83		103		139		179		106		130		351		1143	

県 中

	10	割合	20	割合	30	割合	40	割合	50	割合	64	割合	69	割合	70～	割合	全体数	割合
1と回答																		
男性	0	0.0%	0	0.0%	1	1.9%	0	0.0%	2	2.9%	0	0.0%	1	1.8%	3	2.7%	7	1.6%
女性	0	0.0%	0	0.0%	4	8.5%	4	5.7%	8	9.4%	4	8.5%	1	1.5%	5	4.7%	26	5.5%
男女合計	0	0.0%	0	0.0%	5	5.0%	4	2.8%	10	6.5%	4	4.4%	2	1.6%	8	3.7%	33	3.6%
2と回答																		
男性	5	31.3%	2	8.3%	10	18.5%	13	18.3%	13	19.1%	6	13.6%	7	12.3%	25	22.7%	81	18.2%
女性	3	14.3%	9	28.1%	9	19.1%	25	35.7%	27	31.8%	12	25.5%	23	34.8%	26	24.5%	134	28.3%
男女合計	8	21.6%	11	19.6%	19	18.8%	38	27.0%	40	26.1%	18	19.8%	30	24.4%	51	23.6%	215	23.4%
3と回答																		
男性	11	68.8%	22	91.7%	43	79.6%	58	81.7%	50	73.5%	37	84.1%	47	82.5%	76	69.1%	344	77.5%
女性	18	85.7%	23	71.9%	34	72.3%	41	58.6%	49	57.6%	31	66.0%	40	60.6%	65	61.3%	301	63.5%
男女合計	29	78.4%	45	80.4%	77	76.2%	99	70.2%	99	64.7%	68	74.7%	87	70.7%	141	65.3%	645	70.3%
無回答																		
男性	0	0.0%	0	0.0%	0	0.0%	0	0.0%	3	4.4%	1	2.3%	2	3.5%	6	5.5%	12	2.7%
女性	0	0.0%	0	0.0%	0	0.0%	0	0.0%	1	1.2%	0	0.0%	2	3.0%	10	9.4%	13	2.7%
男女合計	0	0.0%	0	0.0%	0	0.0%	0	0.0%	4	2.6%	1	1.1%	4	3.3%	16	7.4%	25	2.7%
全体(人)																		
男性	16		24		54		71		68		44		57		110		444	
女性	21		32		47		70		85		47		66		106		474	
男女合計	37		56		101		141		153		91		123		216		918	

県 南

	10	割合	20	割合	30	割合	40	割合	50	割合	64	割合	69	割合	70～	割合	全体数	割合
1と回答																		
男性	0	0.0%	2	15.4%	1	8.3%	1	4.8%	0	0.0%	1	4.8%	1	4.0%	3	4.8%	9	4.9%
女性	0	0.0%	0	0.0%	1	10.0%	0	0.0%	2	7.1%	3	12.0%	1	3.8%	1	1.4%	8	4.3%
男女合計	0	0.0%	2	11.8%	2	9.1%	1	2.4%	2	3.5%	4	8.7%	2	3.9%	4	3.1%	17	4.6%
2と回答																		
男性	0	0.0%	4	30.8%	2	16.7%	2	9.5%	4	13.8%	5	23.8%	4	16.0%	17	27.4%	38	20.7%
女性	2	50.0%	2	50.0%	2	20.0%	8	38.1%	9	32.1%	7	28.0%	10	38.5%	28	40.6%	68	36.4%
男女合計	2	40.0%	6	35.3%	4	18.2%	10	23.8%	13	22.8%	12	26.1%	14	27.5%	45	34.4%	106	28.6%
3と回答																		
男性	1	100.0%	7	53.8%	8	66.7%	18	85.7%	25	86.2%	15	71.4%	19	76.0%	42	67.7%	135	73.4%
女性	2	50.0%	2	50.0%	7	70.0%	13	61.9%	16	57.1%	15	60.0%	15	57.7%	36	52.2%	106	56.7%
男女合計	3	60.0%	9	52.9%	15	68.2%	31	73.8%	41	71.9%	30	65.2%	34	66.7%	78	59.5%	241	65.0%
無回答																		
男性	0	0.0%	0	0.0%	1	8.3%	0	0.0%	0	0.0%	0	0.0%	1	4.0%	0	0.0%	2	1.1%
女性	0	0.0%	0	0.0%	0	0.0%	0	0.0%	1	3.6%	0	0.0%	0	0.0%	4	5.8%	5	2.7%
男女合計	0	0.0%	0	0.0%	1	4.5%	0	0.0%	1	1.8%	0	0.0%	1	2.0%	4	3.1%	7	1.9%
全体(人)																		
男性	1		13		12		21		29		21		25		62		184	
女性	4		4		10		21		28		25		26		69		187	
男女合計	5		17		22		42		57		46		51		131		371	

会 津

	10	割合	20	割合	30	割合	40	割合	50	割合	64	割合	69	割合	70～	割合	全体数	割合
1と回答																		
男性	0	0.0%	0	0.0%	0	0.0%	2	8.0%	1	3.1%	0	0.0%	0	0.0%	6	5.0%	9	3.1%
女性	1	20.0%	2	14.3%	0	0.0%	2	7.4%	3	8.1%	0	0.0%	1	3.1%	6	4.6%	15	5.0%
男女合計	1	5.9%	2	7.4%	0	0.0%	4	7.7%	4	5.8%	0	0.0%	1	1.5%	12	4.8%	24	4.1%
2と回答																		
男性	3	25.0%	2	15.4%	5	25.0%	5	20.0%	6	18.8%	4	11.4%	8	24.2%	19	16.0%	52	18.0%
女性	2	40.0%	2	14.3%	13	59.1%	9	33.3%	10	27.0%	9	28.1%	10	31.3%	39	30.0%	94	31.4%
男女合計	5	29.4%	4	14.8%	18	42.9%	14	26.9%	16	23.2%	13	19.4%	18	27.7%	58	23.3%	146	24.8%
3と回答																		
男性	9	75.0%	11	84.6%	13	65.0%	17	68.0%	24	75.0%	30	85.7%	25	75.8%	90	75.6%	219	75.8%
女性	2	40.0%	9	64.3%	9	40.9%	15	55.6%	22	59.5%	23	71.9%	20	62.5%	78	60.0%	178	59.5%
男女合計	11	64.7%	20	74.1%	22	52.4%	32	61.5%	46	66.7%	53	79.1%	45	69.2%	168	67.5%	397	67.5%
無回答																		
男性	0	0.0%	0	0.0%	2	10.0%	1	4.0%	1	3.1%	1	2.9%	0	0.0%	4	3.4%	9	3.1%
女性	0	0.0%	1	7.1%	0	0.0%	1	3.7%	2	5.4%	0	0.0%	1	3.1%	7	5.4%	12	4.0%
男女合計	0	0.0%	1	3.7%	2	4.8%	2	3.8%	3	4.3%	1	1.5%	1	1.5%	11	4.4%	21	3.6%
全体(人)																		
男性	12		13		20		25		32		35		33		119		289	
女性	5		14		22		27		37		32		32		130		299	
男女合計	17		27		42		52		69		67		65		249		588	

南 会 津

	10	割合	20	割合	30	割合	40	割合	50	割合	64	割合	69	割合	70～	割合	全体数	割合
1と回答																		
男性	0	0.0%	0	0.0%	0	0.0%	0	0.0%	0	0.0%	0	0.0%	0	0.0%	1	5.0%	1	2.6%
女性	0	0.0%	0	0.0%	0	0.0%	0	0.0%	0	0.0%	0	0.0%	0	0.0%	1	6.7%	1	2.9%
男女合計	0	0.0%	0	0.0%	0	0.0%	0	0.0%	0	0.0%	0	0.0%	0	0.0%	2	5.7%	2	2.7%
2と回答																		
男性	2	100.0%	0	0.0%	1	100.0%	2	66.7%	0	0.0%	0	0.0%	1	25.0%	4	20.0%	10	26.3%
女性	2	66.7%	0	0.0%	1	100.0%	2	40.0%	1	33.3%	0	0.0%	2	33.3%	4	26.7%	12	34.3%
男女合計	4	80.0%	0	0.0%	2	100.0%	4	50.0%	1	16.7%	0	0.0%	3	30.0%	8	22.9%	22	30.1%
3と回答																		
男性	0	0.0%	2	100.0%	0	0.0%	1	33.3%	3	100.0%	3	100.0%	3	75.0%	15	75.0%	27	71.1%
女性	1	33.3%	0	0.0%	0	0.0%	3	60.0%	2	66.7%	2	100.0%	4	66.7%	9	60.0%	21	60.0%
男女合計	1	20.0%	2	100.0%	0	0.0%	4	50.0%	5	83.3%	5	100.0%	7	70.0%	24	68.6%	48	65.8%
無回答																		
男性	0	0.0%	0	0.0%	0	0.0%	0	0.0%	0	0.0%	0	0.0%	0	0.0%	0	0.0%	0	0.0%
女性	0	0.0%	0	0.0%	0	0.0%	0	0.0%	0	0.0%	0	0.0%	0	0.0%	1	6.7%	1	2.9%
男女合計	0	0.0%	0	0.0%	0	0.0%	0	0.0%	0	0.0%	0	0.0%	0	0.0%	1	2.9%	1	1.4%
全体(人)																		
男性	2		2		1		3		3		3		4		20		38	
女性	3		0		1		5		3		2		6		15		35	
男女合計	5		2		2		8		6		5		10		35		73	

相 双

	10	割合	20	割合	30	割合	40	割合	50	割合	64	割合	69	割合	70～	割合	全体数	割合
1と回答																		
男性	0	0.0%	0	0.0%	0	0.0%	0	0.0%	0	0.0%	1	7.7%	2	8.0%	1	2.6%	4	3.3%
女性	0	0.0%	0	0.0%	0	0.0%	0	0.0%	2	9.5%	0	0.0%	0	0.0%	1	2.1%	3	2.3%
男女合計	0	0.0%	0	0.0%	0	0.0%	0	0.0%	2	6.1%	1	3.6%	2	4.2%	2	2.3%	7	2.8%
2と回答																		
男性	1	25.0%	1	11.1%	0	0.0%	1	12.5%	3	25.0%	3	23.1%	1	4.0%	7	17.9%	17	14.2%
女性	0	0.0%	1	20.0%	2	25.0%	4	36.4%	7	33.3%	6	40.0%	7	30.4%	16	33.3%	43	32.6%
男女合計	1	20.0%	2	14.3%	2	11.1%	5	26.3%	10	30.3%	9	32.1%	8	16.7%	23	26.4%	60	23.8%
3と回答																		
男性	3	75.0%	8	88.9%	10	100.0%	5	62.5%	9	75.0%	8	61.5%	21	84.0%	31	79.5%	95	79.2%
女性	1	100.0%	4	80.0%	6	75.0%	6	54.5%	12	57.1%	9	60.0%	16	69.6%	29	60.4%	83	62.9%
男女合計	4	80.0%	12	85.7%	16	88.9%	11	57.9%	21	63.6%	17	60.7%	37	77.1%	60	69.0%	178	70.6%
無回答																		
男性	0	0.0%	0	0.0%	0	0.0%	2	25.0%	0	0.0%	1	7.7%	1	4.0%	0	0.0%	4	3.3%
女性	0	0.0%	0	0.0%	0	0.0%	1	9.1%	0	0.0%	0	0.0%	0	0.0%	2	4.2%	3	2.3%
男女合計	0	0.0%	0	0.0%	0	0.0%	3	15.8%	0	0.0%	1	3.6%	1	2.1%	2	2.3%	7	2.8%
全体(人)																		
男性	4		9		10		8		12		13		25		39		120	
女性	1		5		8		11		21		15		23		48		132	
男女合計	5		14		18		19		33		28		48		87		252	

いわき

	10	割合	20	割合	30	割合	40	割合	50	割合	64	割合	69	割合	70～	割合	全体数	割合
1と回答																		
男性	0	0.0%	1	4.8%	0	0.0%	1	1.9%	1	2.0%	1	4.0%	1	2.7%	3	3.0%	8	2.3%
女性	0	0.0%	3	13.6%	0	0.0%	3	5.6%	3	5.3%	1	3.1%	1	2.8%	7	5.8%	18	4.8%
男女合計	0	0.0%	4	9.3%	0	0.0%	4	3.7%	4	3.8%	2	3.5%	2	2.7%	10	4.5%	26	3.6%
2と回答																		
男性	0	0.0%	2	9.5%	5	9.8%	5	9.3%	6	12.2%	4	16.0%	6	16.2%	21	21.2%	49	14.1%
女性	1	9.1%	3	13.6%	14	35.0%	19	35.2%	12	21.1%	9	28.1%	12	33.3%	31	25.6%	101	27.1%
男女合計	1	4.3%	5	11.6%	19	20.9%	24	22.2%	18	17.0%	13	22.8%	18	24.7%	52	23.6%	150	20.8%
3と回答																		
男性	11	91.7%	17	81.0%	45	88.2%	47	87.0%	41	83.7%	19	76.0%	30	81.1%	70	70.7%	280	80.5%
女性	9	81.8%	14	63.6%	26	65.0%	31	57.4%	40	70.2%	21	65.6%	22	61.1%	77	63.6%	240	64.3%
男女合計	20	87.0%	31	72.1%	71	78.0%	78	72.2%	81	76.4%	40	70.2%	52	71.2%	147	66.8%	520	72.1%
無回答																		
男性	1	8.3%	1	4.8%	1	2.0%	1	1.9%	1	2.0%	1	4.0%	0	0.0%	5	5.1%	11	3.2%
女性	1	9.1%	2	9.1%	0	0.0%	1	1.9%	2	3.5%	1	3.1%	1	2.8%	6	5.0%	14	3.8%
男女合計	2	8.7%	3	7.0%	1	1.1%	2	1.9%	3	2.8%	2	3.5%	1	1.4%	11	5.0%	25	3.5%
全体(人)																		
男性	12		21		51		54		49		25		37		99		348	
女性	11		22		40		54		57		32		36		121		373	
男女合計	23		43		91		108		106		57		73		220		721	

全県(60歳以上・再掲)

	64	割合	69	割合	70	割合	80	割合	90	割合	全体数	割合
1と回答												
男性	4	2.0%	7	2.9%	9	2.3%	8	3.9%	2	11.1%	30	2.8%
女性	9	4.4%	6	2.4%	19	5.2%	9	3.6%	0	0.0%	43	3.8%
男女合計	13	3.3%	13	2.6%	28	3.7%	17	3.8%	2	2.8%	73	3.3%
2と回答												
男性	34	17.3%	35	14.3%	87	21.9%	31	15.3%	4	22.2%	191	18.0%
女性	55	27.1%	87	34.1%	130	35.3%	58	23.3%	3	5.7%	333	29.5%
男女合計	89	22.3%	122	24.4%	217	28.3%	89	19.7%	7	9.9%	524	23.9%
3と回答												
男性	154	78.2%	196	80.0%	293	73.6%	153	75.4%	11	61.1%	807	76.1%
女性	137	67.5%	154	60.4%	207	56.3%	161	64.7%	44	83.0%	703	62.3%
男女合計	291	72.8%	350	70.0%	500	65.3%	314	69.5%	55	77.5%	1510	69.0%
無回答												
男性	5	2.5%	7	2.9%	9	2.3%	11	5.4%	1	5.6%	33	3.1%
女性	2	1.0%	8	3.1%	12	3.3%	21	8.4%	6	11.3%	49	4.3%
男女合計	7	1.8%	15	3.0%	21	2.7%	32	7.1%	7	9.9%	82	3.7%
全体(人)												
男性	197		245		398		203		18		1061	
女性	203		255		368		249		53		1128	
男女合計	400		500		766		452		71		2189	

8 食生活（栄養バランス）の状況（満15歳以上対象）（調査票 問8）

問8 あなたは、日頃から栄養バランスのとれた食生活を実践していますか。

1 はい 2 いいえ

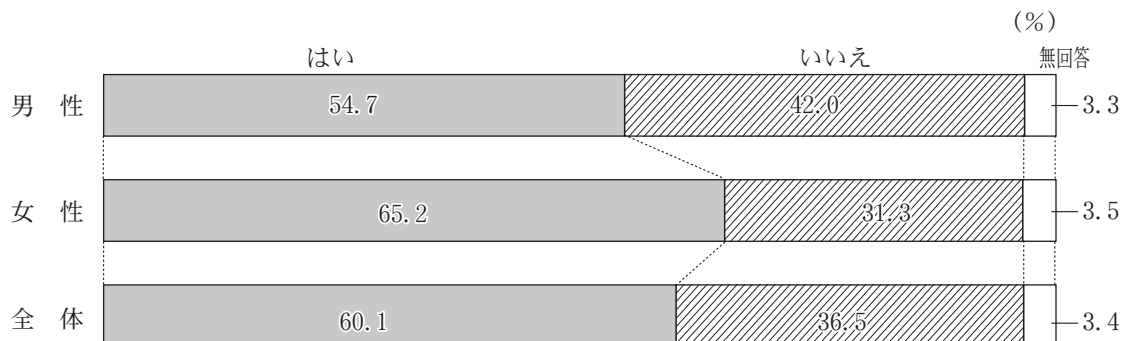

	10	割合	20	割合	30	割合	40	割合	50	割合	64	割合	69	割合	70	割合	80	割合	90	割合	全体数	割合
1と回答																						
男性	40	52.6%	52	43.3%	77	37.4%	107	42.3%	135	49.6%	117	59.4%	148	60.4%	265	66.6%	134	66.0%	13	72.2%	1088	54.7%
女性	35	51.5%	61	50.0%	100	57.8%	151	59.0%	212	64.0%	138	68.0%	187	73.3%	271	73.6%	167	67.1%	32	60.4%	1354	65.2%
男女合計	75	52.1%	113	46.7%	177	46.7%	258	50.7%	347	57.5%	255	63.8%	335	67.0%	536	70.0%	301	66.6%	45	63.4%	2442	60.1%
2と回答																						
男性	33	43.4%	65	54.2%	122	59.2%	137	54.2%	130	47.8%	77	39.1%	88	35.9%	121	30.4%	57	28.1%	4	22.2%	834	42.0%
女性	31	45.6%	56	45.9%	71	41.0%	98	38.3%	110	33.2%	61	30.0%	61	23.9%	79	21.5%	71	28.5%	13	24.5%	651	31.3%
男女合計	64	44.4%	121	50.0%	193	50.9%	235	46.2%	240	39.8%	138	34.5%	149	29.8%	200	26.1%	128	28.3%	17	23.9%	1485	36.5%
無回答																						
男性	3	3.9%	3	2.5%	7	3.4%	9	3.6%	7	2.6%	3	1.5%	9	3.7%	12	3.0%	12	5.9%	1	5.6%	66	3.3%
女性	2	2.9%	5	4.1%	2	1.2%	7	2.7%	9	2.7%	4	2.0%	7	2.7%	18	4.9%	11	4.4%	8	15.1%	73	3.5%
男女合計	5	3.5%	8	3.3%	9	2.4%	16	3.1%	16	2.7%	7	1.8%	16	3.2%	30	3.9%	23	5.1%	9	12.7%	139	3.4%
全体(人)																						
男性	76		120		206		253		272		197		245		398		203		18		1988	
女性	68		122		173		256		331		203		255		368		249		53		2078	
男女合計	144		242		379		509		603		400		500		766		452		71		4066	

県 北

	10	割合	20	割合	30	割合	40	割合	50	割合	64	割合	69	割合	70～	割合	全体数	割合
1と回答																		
男性	18	62.1%	17	44.7%	20	34.5%	35	49.3%	40	50.6%	38	67.9%	36	56.3%	118	69.4%	322	57.0%
女性	13	56.5%	23	51.1%	24	53.3%	37	54.4%	70	70.0%	34	68.0%	47	71.2%	125	69.1%	373	64.5%
男女合計	31	59.6%	40	48.2%	44	42.7%	72	51.8%	110	61.5%	72	67.9%	83	63.8%	243	69.2%	695	60.8%
2と回答																		
男性	9	31.0%	19	50.0%	36	62.1%	32	45.1%	37	46.8%	17	30.4%	24	37.5%	45	26.5%	219	38.8%
女性	9	39.1%	20	44.4%	19	42.2%	28	41.2%	27	27.0%	15	30.0%	16	24.2%	47	26.0%	181	31.3%
男女合計	18	34.6%	39	47.0%	55	53.4%	60	43.2%	64	35.8%	32	30.2%	40	30.8%	92	26.2%	400	35.0%
無回答																		
男性	2	6.9%	2	5.3%	2	3.4%	4	5.6%	2	2.5%	1	1.8%	4	6.3%	7	4.1%	24	4.2%
女性	1	4.3%	2	4.4%	2	4.4%	3	4.4%	3	3.0%	1	2.0%	3	4.5%	9	5.0%	24	4.2%
男女合計	3	5.8%	4	4.8%	4	3.9%	7	5.0%	5	2.8%	2	1.9%	7	5.4%	16	4.6%	48	4.2%
全体(人)																		
男性	29		38		58		71		79		56		64		170		565	
女性	23		45		45		68		100		50		66		181		578	
男女合計	52		83		103		139		179		106		130		351		1143	

県 中

	10	割合	20	割合	30	割合	40	割合	50	割合	64	割合	69	割合	70～	割合	全体数	割合
1と回答																		
男性	7	43.8%	13	54.2%	20	37.0%	28	39.4%	37	54.4%	24	54.5%	33	57.9%	64	58.2%	226	50.9%
女性	10	47.6%	16	50.0%	29	61.7%	47	67.1%	46	54.1%	29	61.7%	46	69.7%	70	66.0%	293	61.8%
男女合計	17	45.9%	29	51.8%	49	48.5%	75	53.2%	83	54.2%	53	58.2%	79	64.2%	134	62.0%	519	56.5%
2と回答																		
男性	9	56.3%	11	45.8%	34	63.0%	43	60.6%	29	42.6%	19	43.2%	21	36.8%	39	35.5%	205	46.2%
女性	11	52.4%	16	50.0%	18	38.3%	23	32.9%	38	44.7%	18	38.3%	19	28.8%	29	27.4%	172	36.3%
男女合計	20	54.1%	27	48.2%	52	51.5%	66	46.8%	67	43.8%	37	40.7%	40	32.5%	68	31.5%	377	41.1%
無回答																		
男性	0	0.0%	0	0.0%	0	0.0%	0	0.0%	2	2.9%	1	2.3%	3	5.3%	7	6.4%	13	2.9%
女性	0	0.0%	0	0.0%	0	0.0%	0	0.0%	1	1.2%	0	0.0%	1	1.5%	7	6.6%	9	1.9%
男女合計	0	0.0%	0	0.0%	0	0.0%	0	0.0%	3	2.0%	1	1.1%	4	3.3%	14	6.5%	22	2.4%
全体(人)																		
男性	16		24		54		71		68		44		57		110		444	
女性	21		32		47		70		85		47		66		106		474	
男女合計	37		56		101		141		153		91		123		216		918	

県 南

	10	割合	20	割合	30	割合	40	割合	50	割合	64	割合	69	割合	70～	割合	全体数	割合
1と回答																		
男性	0	0.0%	4	30.8%	7	58.3%	10	47.6%	14	48.3%	13	61.9%	16	64.0%	45	72.6%	109	59.2%
女性	2	50.0%	2	50.0%	6	60.0%	11	52.4%	18	64.3%	19	76.0%	20	76.9%	52	75.4%	130	69.5%
男女合計	2	40.0%	6	35.3%	13	59.1%	21	50.0%	32	56.1%	32	69.6%	36	70.6%	97	74.0%	239	64.4%
2と回答																		
男性	1	100.0%	9	69.2%	4	33.3%	11	52.4%	14	48.3%	8	38.1%	8	32.0%	15	24.2%	70	38.0%
女性	2	50.0%	2	50.0%	4	40.0%	10	47.6%	9	32.1%	5	20.0%	5	19.2%	15	21.7%	52	27.8%
男女合計	3	60.0%	11	64.7%	8	36.4%	21	50.0%	23	40.4%	13	28.3%	13	25.5%	30	22.9%	122	32.9%
無回答																		
男性	0	0.0%	0	0.0%	1	8.3%	0	0.0%	1	3.4%	0	0.0%	1	4.0%	2	3.2%	5	2.7%
女性	0	0.0%	0	0.0%	0	0.0%	0	0.0%	1	3.6%	1	4.0%	1	3.8%	2	2.9%	5	2.7%
男女合計	0	0.0%	0	0.0%	1	4.5%	0	0.0%	2	3.5%	1	2.2%	2	3.9%	4	3.1%	10	2.7%
全体(人)																		
男性	1		13		12		21		29		21		25		62		184	
女性	4		4		10		21		28		25		26		69		187	
男女合計	5		17		22		42		57		46		51		131		371	

会 津

	10	割合	20	割合	30	割合	40	割合	50	割合	64	割合	69	割合	70～	割合	全体数	割合
1と回答																		
男性	7	58.3%	6	46.2%	10	50.0%	13	52.0%	13	40.6%	17	48.6%	25	75.8%	80	67.2%	171	59.2%
女性	3	60.0%	7	50.0%	16	72.7%	16	59.3%	24	64.9%	26	81.3%	23	71.9%	91	70.0%	206	68.9%
男女合計	10	58.8%	13	48.1%	26	61.9%	29	55.8%	37	53.6%	43	64.2%	48	73.8%	171	68.7%	377	64.1%
2と回答																		
男性	4	33.3%	7	53.8%	8	40.0%	10	40.0%	18	56.3%	17	48.6%	8	24.2%	34	28.6%	106	36.7%
女性	2	40.0%	6	42.9%	6	27.3%	9	33.3%	11	29.7%	6	18.8%	8	25.0%	30	23.1%	78	26.1%
男女合計	6	35.3%	13	48.1%	14	33.3%	19	36.5%	29	42.0%	23	34.3%	16	24.6%	64	25.7%	184	31.3%
無回答																		
男性	1	8.3%	0	0.0%	2	10.0%	2	8.0%	1	3.1%	1	2.9%	0	0.0%	5	4.2%	12	4.2%
女性	0	0.0%	1	7.1%	0	0.0%	2	7.4%	2	5.4%	0	0.0%	1	3.1%	9	6.9%	15	5.0%
男女合計	1	5.9%	1	3.7%	2	4.8%	4	7.7%	3	4.3%	1	1.5%	1	1.5%	14	5.6%	27	4.6%
全体(人)																		
男性	12		13		20		25		32		35		33		119		289	
女性	5		14		22		27		37		32		32		130		299	
男女合計	17		27		42		52		69		67		65		249		588	

南会津

	10	割合	20	割合	30	割合	40	割合	50	割合	64	割合	69	割合	70～	割合	全体数	割合
1と回答																		
男性	1	50.0%	2	100.0%	0	0.0%	2	66.7%	0	0.0%	1	33.3%	2	50.0%	13	65.0%	21	55.3%
女性	0	0.0%	0	0.0%	0	0.0%	2	40.0%	2	66.7%	1	50.0%	5	83.3%	8	53.3%	18	51.4%
男女合計	1	20.0%	2	100.0%	0	0.0%	4	50.0%	2	33.3%	2	40.0%	7	70.0%	21	60.0%	39	53.4%
2と回答																		
男性	1	50.0%	0	0.0%	1	100.0%	1	33.3%	3	100.0%	2	66.7%	2	50.0%	7	35.0%	17	44.7%
女性	3	100.0%	0	0.0%	1	100.0%	3	60.0%	1	33.3%	1	50.0%	1	16.7%	6	40.0%	16	45.7%
男女合計	4	80.0%	0	0.0%	2	100.0%	4	50.0%	4	66.7%	3	60.0%	3	30.0%	13	37.1%	33	45.2%
無回答																		
男性	0	0.0%	0	0.0%	0	0.0%	0	0.0%	0	0.0%	0	0.0%	0	0.0%	0	0.0%	0	0.0%
女性	0	0.0%	0	0.0%	0	0.0%	0	0.0%	0	0.0%	0	0.0%	0	0.0%	1	6.7%	1	2.9%
男女合計	0	0.0%	0	0.0%	0	0.0%	0	0.0%	0	0.0%	0	0.0%	0	0.0%	1	2.9%	1	1.4%
全体(人)																		
男性	2		2		1		3		3		3		4		20		38	
女性	3		0		1		5		3		2		6		15		35	
男女合計	5		2		2		8		6		5		10		35		73	

相 双

	10	割合	20	割合	30	割合	40	割合	50	割合	64	割合	69	割合	70～	割合	全体数	割合
1と回答																		
男性	3	75.0%	2	22.2%	2	20.0%	2	25.0%	6	50.0%	8	61.5%	14	56.0%	26	66.7%	63	52.5%
女性	0	0.0%	2	40.0%	3	37.5%	6	54.5%	15	71.4%	10	66.7%	18	78.3%	41	85.4%	95	72.0%
男女合計	3	60.0%	4	28.6%	5	27.8%	8	42.1%	21	63.6%	18	64.3%	32	66.7%	67	77.0%	158	62.7%
2と回答																		
男性	1	25.0%	7	77.8%	8	80.0%	4	50.0%	6	50.0%	5	38.5%	10	40.0%	13	33.3%	54	45.0%
女性	1	100.0%	3	60.0%	5	62.5%	4	36.4%	6	28.6%	5	33.3%	5	21.7%	7	14.6%	36	27.3%
男女合計	2	40.0%	10	71.4%	13	72.2%	8	42.1%	12	36.4%	10	35.7%	15	31.3%	20	23.0%	90	35.7%
無回答																		
男性	0	0.0%	0	0.0%	0	0.0%	2	25.0%	0	0.0%	0	0.0%	1	4.0%	0	0.0%	3	2.5%
女性	0	0.0%	0	0.0%	0	0.0%	1	9.1%	0	0.0%	0	0.0%	0	0.0%	0	0.0%	1	0.8%
男女合計	0	0.0%	0	0.0%	0	0.0%	3	15.8%	0	0.0%	0	0.0%	1	2.1%	0	0.0%	4	1.6%
全体(人)																		
男性	4		9		10		8		12		13		25		39		120	
女性	1		5		8		11		21		15		23		48		132	
男女合計	5		14		18		19		33		28		48		87		252	

いわき

	10	割合	20	割合	30	割合	40	割合	50	割合	64	割合	69	割合	70～	割合	全体数	割合
1と回答																		
男性	4	33.3%	8	38.1%	18	35.3%	17	31.5%	25	51.0%	16	64.0%	22	59.5%	66	66.7%	176	50.6%
女性	7	63.6%	11	50.0%	22	55.0%	32	59.3%	37	64.9%	19	59.4%	28	77.8%	83	68.6%	239	64.1%
男女合計	11	47.8%	19	44.2%	40	44.0%	49	45.4%	62	58.5%	35	61.4%	50	68.5%	149	67.7%	415	57.6%
2と回答																		
男性	8	66.7%	12	57.1%	31	60.8%	36	66.7%	23	46.9%	9	36.0%	15	40.5%	29	29.3%	163	46.8%
女性	3	27.3%	9	40.9%	18	45.0%	21	38.9%	18	31.6%	11	34.4%	7	19.4%	29	24.0%	116	31.1%
男女合計	11	47.8%	21	48.8%	49	53.8%	57	52.8%	41	38.7%	20	35.1%	22	30.1%	58	26.4%	279	38.7%
無回答																		
男性	0	0.0%	1	4.8%	2	3.9%	1	1.9%	1	2.0%	0	0.0%	0	0.0%	4	4.0%	9	2.6%
女性	1	9.1%	2	9.1%	0	0.0%	1	1.9%	2	3.5%	2	6.3%	1	2.8%	9	7.4%	18	4.8%
男女合計	1	4.3%	3	7.0%	2	2.2%	2	1.9%	3	2.8%	2	3.5%	1	1.4%	13	5.9%	27	3.7%
全体(人)																		
男性	12		21		51		54		49		25		37		99		348	
女性	11		22		40		54		57		32		36		121		373	
男女合計	23		43		91		108		106		57		73		220		721	

全県(60歳以上・再掲)

	64	割合	69	割合	70	割合	80	割合	90	割合	全体数	割合
1と回答												
男性	117	59.4%	148	60.4%	265	66.6%	134	66.0%	13	72.2%	677	63.8%
女性	138	68.0%	187	73.3%	271	73.6%	167	67.1%	32	60.4%	795	70.5%
男女合計	255	63.8%	335	67.0%	536	70.0%	301	66.6%	45	63.4%	1472	67.2%
2と回答												
男性	77	39.1%	88	35.9%	121	30.4%	57	28.1%	4	22.2%	347	32.7%
女性	61	30.0%	61	23.9%	79	21.5%	71	28.5%	13	24.5%	285	25.3%
男女合計	138	34.5%	149	29.8%	200	26.1%	128	28.3%	17	23.9%	632	28.9%
無回答												
男性	3	1.5%	9	3.7%	12	3.0%	12	5.9%	1	5.6%	37	3.5%
女性	4	2.0%	7	2.7%	18	4.9%	11	4.4%	8	15.1%	48	4.3%
男女合計	7	1.8%	16	3.2%	30	3.9%	23	5.1%	9	12.7%	85	3.9%
全体(人)												
男性	197		245		398		203		18		1061	
女性	203		255		368		249		53		1128	
男女合計	400		500		766		452		71		2189	

9 「ロコモティブシンドローム」の認知度（満15歳以上対象）（調査票 問9）

問9 あなたは、ロコモティブシンドローム（運動器症候群）を知っていましたか。（○は1つ）

1 知っている 2 知らない

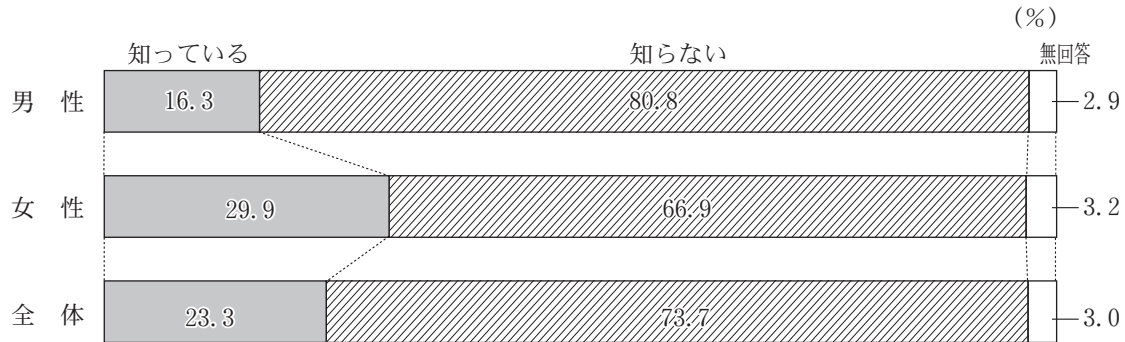

	10	割合	20	割合	30	割合	40	割合	50	割合	64	割合	69	割合	70	割合	80	割合	90	割合	全体数	割合
1と回答																						
男性	6	7.9%	17	14.2%	34	16.5%	47	18.6%	39	14.3%	26	13.2%	34	13.9%	92	23.1%	26	12.8%	4	22.2%	325	16.3%
女性	7	10.3%	31	25.4%	50	28.9%	79	30.9%	117	35.3%	72	35.5%	95	37.3%	123	33.4%	42	16.9%	6	11.3%	622	29.9%
男女合計	13	9.0%	48	19.8%	84	22.2%	126	24.8%	156	25.9%	98	24.5%	129	25.8%	215	28.1%	68	15.0%	10	14.1%	947	23.3%
2と回答																						
男性	67	88.2%	100	83.3%	166	80.6%	198	78.3%	227	83.5%	167	84.8%	204	83.3%	296	74.4%	168	82.8%	13	72.2%	1606	80.8%
女性	59	86.8%	85	69.7%	121	69.9%	171	66.8%	207	62.5%	130	64.0%	152	59.6%	230	62.5%	195	78.3%	40	75.5%	1390	66.9%
男女合計	126	87.5%	185	76.4%	287	75.7%	369	72.5%	434	72.0%	297	74.3%	356	71.2%	526	68.7%	363	80.3%	53	74.6%	2996	73.7%
無回答																						
男性	3	3.9%	3	2.5%	6	2.9%	8	3.2%	6	2.2%	4	2.0%	7	2.9%	10	2.5%	9	4.4%	1	5.6%	57	2.9%
女性	2	2.9%	6	4.9%	2	1.2%	6	2.3%	7	2.1%	1	0.5%	8	3.1%	15	4.1%	12	4.8%	7	13.2%	66	3.2%
男女合計	5	3.5%	9	3.7%	8	2.1%	14	2.8%	13	2.2%	5	1.3%	15	3.0%	25	3.3%	21	4.6%	8	11.3%	123	3.0%
全体(人)																						
男性	76		120		206		253		272		197		245		398		203		18		1988	
女性	68		122		173		256		331		203		255		368		249		53		2078	
男女合計	144		242		379		509		603		400		500		766		452		71		4066	

県 北

	10	割合	20	割合	30	割合	40	割合	50	割合	64	割合	69	割合	70～	割合	全体数	割合
1と回答																		
男性	1	3.4%	4	10.5%	11	19.0%	13	18.3%	12	15.2%	5	8.9%	7	10.9%	29	17.1%	82	14.5%
女性	3	13.0%	4	8.9%	11	24.4%	23	33.8%	37	37.0%	18	36.0%	29	43.9%	48	26.5%	173	29.9%
男女合計	4	7.7%	8	9.6%	22	21.4%	36	25.9%	49	27.4%	23	21.7%	36	27.7%	77	21.9%	255	22.3%
2と回答																		
男性	26	89.7%	32	84.2%	45	77.6%	54	76.1%	65	82.3%	49	87.5%	54	84.4%	135	79.4%	460	81.4%
女性	19	82.6%	39	86.7%	32	71.1%	42	61.8%	61	61.0%	32	64.0%	34	51.5%	121	66.9%	380	65.7%
男女合計	45	86.5%	71	85.5%	77	74.8%	96	69.1%	126	70.4%	81	76.4%	88	67.7%	256	72.9%	840	73.5%
無回答																		
男性	2	6.9%	2	5.3%	2	3.4%	4	5.6%	2	2.5%	2	3.6%	3	4.7%	6	3.5%	23	4.1%
女性	1	4.3%	2	4.4%	2	4.4%	3	4.4%	2	2.0%	0	0.0%	3	4.5%	12	6.6%	25	4.3%
男女合計	3	5.8%	4	4.8%	4	3.9%	7	5.0%	4	2.2%	2	1.9%	6	4.6%	18	5.1%	48	4.2%
全体(人)																		
男性	29		38		58		71		79		56		64		170		565	
女性	23		45		45		68		100		50		66		181		578	
男女合計	52		83		103		139		179		106		130		351		1143	

県 中

	10	割合	20	割合	30	割合	40	割合	50	割合	64	割合	69	割合	70～	割合	全体数	割合
1と回答																		
男性	2	12.5%	2	8.3%	9	16.7%	19	26.8%	11	16.2%	10	22.7%	13	22.8%	19	17.3%	85	19.1%
女性	4	19.0%	12	37.5%	20	42.6%	31	44.3%	30	35.3%	22	46.8%	21	31.8%	32	30.2%	172	36.3%
男女合計	6	16.2%	14	25.0%	29	28.7%	50	35.5%	41	26.8%	32	35.2%	34	27.6%	51	23.6%	257	28.0%
2と回答																		
男性	14	87.5%	22	91.7%	45	83.3%	52	73.2%	55	80.9%	33	75.0%	42	73.7%	86	78.2%	349	78.6%
女性	17	81.0%	20	62.5%	27	57.4%	39	55.7%	54	63.5%	25	53.2%	42	63.6%	68	64.2%	292	61.6%
男女合計	31	83.8%	42	75.0%	72	71.3%	91	64.5%	109	71.2%	58	63.7%	84	68.3%	154	71.3%	641	69.8%
無回答																		
男性	0	0.0%	0	0.0%	0	0.0%	0	0.0%	2	2.9%	1	2.3%	2	3.5%	5	4.5%	10	2.3%
女性	0	0.0%	0	0.0%	0	0.0%	0	0.0%	1	1.2%	0	0.0%	3	4.5%	6	5.7%	10	2.1%
男女合計	0	0.0%	0	0.0%	0	0.0%	0	0.0%	3	2.0%	1	1.1%	5	4.1%	11	5.1%	20	2.2%
全体(人)																		
男性	16		24		54		71		68		44		57		110		444	
女性	21		32		47		70		85		47		66		106		474	
男女合計	37		56		101		141		153		91		123		216		918	

県 南

	10	割合	20	割合	30	割合	40	割合	50	割合	64	割合	69	割合	70～	割合	全体数	割合
1と回答																		
男性	0	0.0%	3	23.1%	2	16.7%	2	9.5%	3	10.3%	2	9.5%	1	4.0%	13	21.0%	26	14.1%
女性	0	0.0%	2	50.0%	2	20.0%	5	23.8%	9	32.1%	10	40.0%	9	34.6%	15	21.7%	52	27.8%
男女合計	0	0.0%	5	29.4%	4	18.2%	7	16.7%	12	21.1%	12	26.1%	10	19.6%	28	21.4%	78	21.0%
2と回答																		
男性	1	100.0%	10	76.9%	9	75.0%	19	90.5%	26	89.7%	19	90.5%	23	92.0%	48	77.4%	155	84.2%
女性	4	100.0%	2	50.0%	8	80.0%	16	76.2%	18	64.3%	15	60.0%	17	65.4%	50	72.5%	130	69.5%
男女合計	5	100.0%	12	70.6%	17	77.3%	35	83.3%	44	77.2%	34	73.9%	40	78.4%	98	74.8%	285	76.8%
無回答																		
男性	0	0.0%	0	0.0%	1	8.3%	0	0.0%	0	0.0%	0	0.0%	1	4.0%	1	1.6%	3	1.6%
女性	0	0.0%	0	0.0%	0	0.0%	0	0.0%	1	3.6%	0	0.0%	0	0.0%	4	5.8%	5	2.7%
男女合計	0	0.0%	0	0.0%	1	4.5%	0	0.0%	1	1.8%	0	0.0%	1	2.0%	5	3.8%	8	2.2%
全体(人)																		
男性	1		13		12		21		29		21		25		62		184	
女性	4		4		10		21		28		25		26		69		187	
男女合計	5		17		22		42		57		46		51		131		371	

会 津

	10	割合	20	割合	30	割合	40	割合	50	割合	64	割合	69	割合	70～	割合	全体数	割合
1と回答																		
男性	1	8.3%	3	23.1%	5	25.0%	8	32.0%	8	25.0%	3	8.6%	7	21.2%	30	25.2%	65	22.5%
女性	0	0.0%	6	42.9%	8	36.4%	10	37.0%	10	27.0%	9	28.1%	12	37.5%	32	24.6%	87	29.1%
男女合計	1	5.9%	9	33.3%	13	31.0%	18	34.6%	18	26.1%	12	17.9%	19	29.2%	62	24.9%	152	25.9%
2と回答																		
男性	10	83.3%	10	76.9%	13	65.0%	16	64.0%	23	71.9%	31	88.6%	26	78.8%	84	70.6%	213	73.7%
女性	5	100.0%	7	50.0%	14	63.6%	16	59.3%	25	67.6%	23	71.9%	19	59.4%	92	70.8%	201	67.2%
男女合計	15	88.2%	17	63.0%	27	64.3%	32	61.5%	48	69.6%	54	80.6%	45	69.2%	176	70.7%	414	70.4%
無回答																		
男性	1	8.3%	0	0.0%	2	10.0%	1	4.0%	1	3.1%	1	2.9%	0	0.0%	5	4.2%	11	3.8%
女性	0	0.0%	1	7.1%	0	0.0%	1	3.7%	2	5.4%	0	0.0%	1	3.1%	6	4.6%	11	3.7%
男女合計	1	5.9%	1	3.7%	2	4.8%	2	3.8%	3	4.3%	1	1.5%	1	1.5%	11	4.4%	22	3.7%
全体(人)																		
男性	12		13		20		25		32		35		33		119		289	
女性	5		14		22		27		37		32		32		130		299	
男女合計	17		27		42		52		69		67		65		249		588	

南会津

	10	割合	20	割合	30	割合	40	割合	50	割合	64	割合	69	割合	70～	割合	全体数	割合
1と回答																		
男性	0	0.0%	1	50.0%	1	100.0%	0	0.0%	0	0.0%	1	33.3%	0	0.0%	4	20.0%	7	18.4%
女性	0	0.0%	0	0.0%	0	0.0%	1	20.0%	0	0.0%	1	50.0%	2	33.3%	1	6.7%	5	14.3%
男女合計	0	0.0%	1	50.0%	1	50.0%	1	12.5%	0	0.0%	2	40.0%	2	20.0%	5	14.3%	12	16.4%
2と回答																		
男性	2	100.0%	1	50.0%	0	0.0%	3	100.0%	3	100.0%	2	66.7%	4	100.0%	16	80.0%	31	81.6%
女性	3	100.0%	0	0.0%	1	100.0%	4	80.0%	3	100.0%	1	50.0%	4	66.7%	12	80.0%	28	80.0%
男女合計	5	100.0%	1	50.0%	1	50.0%	7	87.5%	6	100.0%	3	60.0%	8	80.0%	28	80.0%	59	80.8%
無回答																		
男性	0	0.0%	0	0.0%	0	0.0%	0	0.0%	0	0.0%	0	0.0%	0	0.0%	0	0.0%	0	0.0%
女性	0	0.0%	0	0.0%	0	0.0%	0	0.0%	0	0.0%	0	0.0%	0	0.0%	2	13.3%	2	5.7%
男女合計	0	0.0%	0	0.0%	0	0.0%	0	0.0%	0	0.0%	0	0.0%	0	0.0%	2	5.7%	2	2.7%
全体(人)																		
男性	2		2		1		3		3		3		4		20		38	
女性	3		0		1		5		3		2		6		15		35	
男女合計	5		2		2		8		6		5		10		35		73	

相 双

	10	割合	20	割合	30	割合	40	割合	50	割合	64	割合	69	割合	70～	割合	全体数	割合
1と回答																		
男性	1	25.0%	1	11.1%	2	20.0%	0	0.0%	0	0.0%	1	7.7%	1	4.0%	6	15.4%	12	10.0%
女性	0	0.0%	0	0.0%	1	12.5%	2	18.2%	8	38.1%	5	33.3%	11	47.8%	11	22.9%	38	28.8%
男女合計	1	20.0%	1	7.1%	3	16.7%	2	10.5%	8	24.2%	6	21.4%	12	25.0%	17	19.5%	50	19.8%
2と回答																		
男性	3	75.0%	8	88.9%	8	80.0%	6	75.0%	12	100.0%	12	92.3%	23	92.0%	33	84.6%	105	87.5%
女性	1	100.0%	5	100.0%	7	87.5%	8	72.7%	13	61.9%	10	66.7%	12	52.2%	36	75.0%	92	69.7%
男女合計	4	80.0%	13	92.9%	15	83.3%	14	73.7%	25	75.8%	22	78.6%	35	72.9%	69	79.3%	197	78.2%
無回答																		
男性	0	0.0%	0	0.0%	0	0.0%	2	25.0%	0	0.0%	0	0.0%	1	4.0%	0	0.0%	3	2.5%
女性	0	0.0%	0	0.0%	0	0.0%	1	9.1%	0	0.0%	0	0.0%	0	0.0%	1	2.1%	2	1.5%
男女合計	0	0.0%	0	0.0%	0	0.0%	3	15.8%	0	0.0%	0	0.0%	1	2.1%	1	1.1%	5	2.0%
全体(人)																		
男性	4		9		10		8		12		13		25		39		120	
女性	1		5		8		11		21		15		23		48		132	
男女合計	5		14		18		19		33		28		48		87		252	

いわき

	10	割合	20	割合	30	割合	40	割合	50	割合	64	割合	69	割合	70～	割合	全体数	割合
1と回答																		
男性	1	8.3%	3	14.3%	4	7.8%	5	9.3%	5	10.2%	4	16.0%	5	13.5%	21	21.2%	48	13.8%
女性	0	0.0%	7	31.8%	8	20.0%	7	13.0%	23	40.4%	7	21.9%	11	30.6%	32	26.4%	95	25.5%
男女合計	1	4.3%	10	23.3%	12	13.2%	12	11.1%	28	26.4%	11	19.3%	16	21.9%	53	24.1%	143	19.8%
2と回答																		
男性	11	91.7%	17	81.0%	46	90.2%	48	88.9%	43	87.8%	21	84.0%	32	86.5%	75	75.8%	293	84.2%
女性	10	90.9%	12	54.5%	32	80.0%	46	85.2%	33	57.9%	24	75.0%	24	66.7%	86	71.1%	267	71.6%
男女合計	21	91.3%	29	67.4%	78	85.7%	94	87.0%	76	71.7%	45	78.9%	56	76.7%	161	73.2%	560	77.7%
無回答																		
男性	0	0.0%	1	4.8%	1	2.0%	1	1.9%	1	2.0%	0	0.0%	0	0.0%	3	3.0%	7	2.0%
女性	1	9.1%	3	13.6%	0	0.0%	1	1.9%	1	1.8%	1	3.1%	1	2.8%	3	2.5%	11	2.9%
男女合計	1	4.3%	4	9.3%	1	1.1%	2	1.9%	2	1.9%	1	1.8%	1	1.4%	6	2.7%	18	2.5%
全体(人)																		
男性	12		21		51		54		49		25		37		99		348	
女性	11		22		40		54		57		32		36		121		373	
男女合計	23		43		91		108		106		57		73		220		721	

全県 (60歳以上・再掲)

	64	割合	69	割合	70	割合	80	割合	90	割合	全体数	割合
1と回答												
男性	26	13.2%	34	13.9%	92	23.1%	26	12.8%	4	22.2%	182	17.2%
女性	72	35.5%	95	37.3%	123	33.4%	42	16.9%	6	11.3%	338	30.0%
男女合計	98	24.5%	129	25.8%	215	28.1%	68	15.0%	10	14.1%	520	23.8%
2と回答												
男性	167	84.8%	204	83.3%	296	74.4%	168	82.8%	13	72.2%	848	79.9%
女性	130	64.0%	152	59.6%	230	62.5%	195	78.3%	40	75.5%	747	66.2%
男女合計	297	74.3%	356	71.2%	526	68.7%	363	80.3%	53	74.6%	1595	72.9%
無回答												
男性	4	2.0%	7	2.9%	10	2.5%	9	4.4%	1	5.6%	31	2.9%
女性	1	0.5%	8	3.1%	15	4.1%	12	4.8%	7	13.2%	43	3.8%
男女合計	5	1.3%	15	3.0%	25	3.3%	21	4.6%	8	11.3%	74	3.4%
全体(人)												
男性	197		245		398		203		18		1061	
女性	203		255		368		249		53		1128	
男女合計	400		500		766		452		71		2189	

10 最近1年間の運動状況（満15歳以上対象）（調査票 問10）

(1) 運動の状況

問10 最近1年間の運動について、あてはまるものを1つ選んで○をつけてください。

- 1 何らかの運動をほとんど毎日している。
- 2 何らかの運動を週2～4回程度している。
- 3 何らかの運動を週1回程度している。
- 4 ほとんど（まったく）していない。

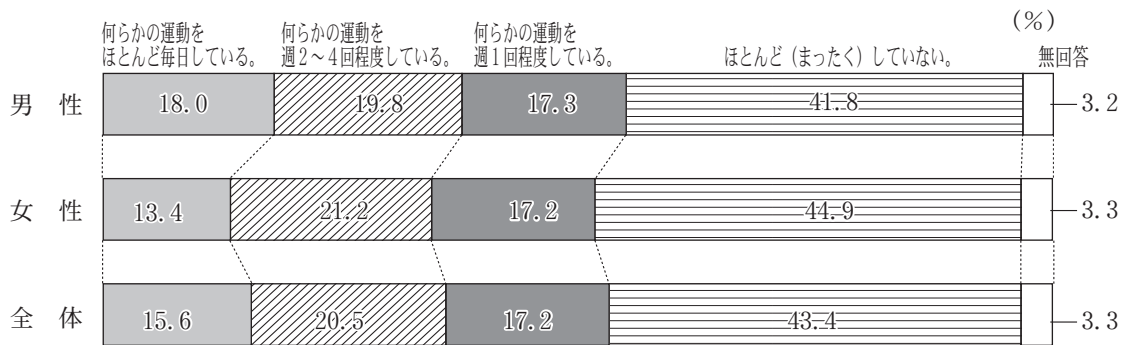

	10	割合	20	割合	30	割合	40	割合	50	割合	64	割合	69	割合	70	割合	80	割合	90	割合	全体数	割合
1と回答																						
男性	34	44.7%	18	15.0%	18	8.7%	16	6.3%	34	12.5%	34	17.3%	46	18.8%	92	23.1%	62	30.5%	3	16.7%	357	18.0%
女性	10	14.7%	4	3.3%	13	7.5%	16	6.3%	26	7.9%	20	9.9%	55	21.6%	90	24.5%	36	14.5%	9	17.0%	279	13.4%
男女合計	44	30.6%	22	9.1%	31	8.2%	32	6.3%	60	10.0%	54	13.5%	101	20.2%	182	23.8%	98	21.7%	12	16.9%	636	15.6%
2と回答																						
男性	13	17.1%	18	15.0%	39	18.9%	32	12.6%	45	16.5%	39	19.8%	67	27.3%	107	26.9%	31	15.3%	2	11.1%	393	19.8%
女性	20	29.4%	19	15.6%	26	15.0%	28	10.9%	59	17.8%	49	24.1%	67	26.3%	107	29.1%	56	22.5%	9	17.0%	440	21.2%
男女合計	33	22.9%	37	15.3%	65	17.2%	60	11.8%	104	17.2%	88	22.0%	134	26.8%	214	27.9%	87	19.2%	11	15.5%	833	20.5%
3と回答																						
男性	10	13.2%	23	19.2%	41	19.9%	49	19.4%	49	18.0%	36	18.3%	38	15.5%	67	16.8%	26	12.8%	4	22.2%	343	17.3%
女性	8	11.8%	25	20.5%	19	11.0%	37	14.5%	62	18.7%	41	20.2%	49	19.2%	64	17.4%	47	18.9%	5	9.4%	357	17.2%
男女合計	18	12.5%	48	19.8%	60	15.8%	86	16.9%	111	18.4%	77	19.3%	87	17.4%	131	17.1%	73	16.2%	9	12.7%	700	17.2%
4と回答																						
男性	17	22.4%	58	48.3%	102	49.5%	147	58.1%	138	50.7%	84	42.6%	84	34.3%	122	30.7%	71	35.0%	8	44.4%	831	41.8%
女性	28	41.2%	69	56.6%	112	64.7%	168	65.6%	176	53.2%	91	44.8%	78	30.6%	91	24.7%	97	39.0%	23	43.4%	933	44.9%
男女合計	45	31.3%	127	52.5%	214	56.5%	315	61.9%	314	52.1%	175	43.8%	162	32.4%	213	27.8%	168	37.2%	31	43.7%	1764	43.4%
無回答																						
男性	2	2.6%	3	2.5%	6	2.9%	9	3.6%	6	2.2%	4	2.0%	10	4.1%	10	2.5%	13	6.4%	1	5.6%	64	3.2%
女性	2	2.9%	5	4.1%	3	1.7%	7	2.7%	8	2.4%	2	1.0%	6	2.4%	16	4.3%	13	5.2%	7	13.2%	69	3.3%
男女合計	4	2.8%	8	3.3%	9	2.4%	16	3.1%	14	2.3%	6	1.5%	16	3.2%	26	3.4%	26	5.8%	8	11.3%	133	3.3%
全体(人)																						
男性	76		120		206		253		272		197		245		398		203		18	1988		
女性	68		122		173		256		331		203		255		368		249		53	2078		
男女合計	144		242		379		509		603		400		500		766		452		71	4066		

県 北

	10	割合	20	割合	30	割合	40	割合	50	割合	64	割合	69	割合	70～	割合	全体数	割合
1と回答																		
男性	15	51.7%	6	15.8%	4	6.9%	4	5.6%	11	13.9%	6	10.7%	13	20.3%	42	24.7%	101	17.9%
女性	4	17.4%	1	2.2%	2	4.4%	4	5.9%	8	8.0%	5	10.0%	14	21.2%	39	21.5%	77	13.3%
男女合計	19	36.5%	7	8.4%	6	5.8%	8	5.8%	19	10.6%	11	10.4%	27	20.8%	81	23.1%	178	15.6%
2と回答																		
男性	3	10.3%	7	18.4%	13	22.4%	6	8.5%	15	19.0%	12	21.4%	16	25.0%	43	25.3%	115	20.4%
女性	7	30.4%	7	15.6%	7	15.6%	7	10.3%	14	14.0%	13	26.0%	17	25.8%	48	26.5%	120	20.8%
男女合計	10	19.2%	14	16.9%	20	19.4%	13	9.4%	29	16.2%	25	23.6%	33	25.4%	91	25.9%	235	20.6%
3と回答																		
男性	4	13.8%	4	10.5%	9	15.5%	19	26.8%	15	19.0%	11	19.6%	14	21.9%	33	19.4%	109	19.3%
女性	4	17.4%	11	24.4%	4	8.9%	11	16.2%	21	21.0%	12	24.0%	16	24.2%	32	17.7%	111	19.2%
男女合計	8	15.4%	15	18.1%	13	12.6%	30	21.6%	36	20.1%	23	21.7%	30	23.1%	65	18.5%	220	19.2%
4と回答																		
男性	5	17.2%	19	50.0%	30	51.7%	38	53.5%	36	45.6%	26	46.4%	18	28.1%	46	27.1%	218	38.6%
女性	7	30.4%	24	53.3%	29	64.4%	43	63.2%	55	55.0%	20	40.0%	16	24.2%	52	28.7%	246	42.6%
男女合計	12	23.1%	43	51.8%	59	57.3%	81	58.3%	91	50.8%	46	43.4%	34	26.2%	98	27.9%	464	40.6%
無回答																		
男性	2	6.9%	2	5.3%	2	3.4%	4	5.6%	2	2.5%	1	1.8%	3	4.7%	6	3.5%	22	3.9%
女性	1	4.3%	2	4.4%	3	6.7%	3	4.4%	2	2.0%	0	0.0%	3	4.5%	10	5.5%	24	4.2%
男女合計	3	5.8%	4	4.8%	5	4.9%	7	5.0%	4	2.2%	1	0.9%	6	4.6%	16	4.6%	46	4.0%
全体(人)																		
男性	29		38		58		71		79		56		64		170		565	
女性	23		45		45		68		100		50		66		181		578	
男女合計	52		83		103		139		179		106		130		351		1143	

県 中

	10	割合	20	割合	30	割合	40	割合	50	割合	64	割合	69	割合	70～	割合	全体数	割合
1と回答																		
男性	6	37.5%	4	16.7%	7	13.0%	5	7.0%	9	13.2%	6	13.6%	15	26.3%	25	22.7%	77	17.3%
女性	2	9.5%	2	6.3%	6	12.8%	3	4.3%	6	7.1%	5	10.6%	15	22.7%	20	18.9%	59	12.4%
男女合計	8	21.6%	6	10.7%	13	12.9%	8	5.7%	15	9.8%	11	12.1%	30	24.4%	45	20.8%	136	14.8%
2と回答																		
男性	3	18.8%	2	8.3%	11	20.4%	13	18.3%	13	19.1%	7	15.9%	13	22.8%	22	20.0%	84	18.9%
女性	8	38.1%	5	15.6%	10	21.3%	6	8.6%	12	14.1%	15	31.9%	16	24.2%	26	24.5%	98	20.7%
男女合計	11	29.7%	7	12.5%	21	20.8%	19	13.5%	25	16.3%	22	24.2%	29	23.6%	48	22.2%	182	19.8%
3と回答																		
男性	3	18.8%	5	20.8%	9	16.7%	12	16.9%	17	25.0%	9	20.5%	5	8.8%	15	13.6%	75	16.9%
女性	2	9.5%	6	18.8%	6	12.8%	14	20.0%	17	20.0%	6	12.8%	11	16.7%	17	16.0%	79	16.7%
男女合計	5	13.5%	11	19.6%	15	14.9%	26	18.4%	34	22.2%	15	16.5%	16	13.0%	32	14.8%	154	16.8%
4と回答																		
男性	4	25.0%	13	54.2%	27	50.0%	41	57.7%	27	39.7%	21	47.7%	20	35.1%	42	38.2%	195	43.9%
女性	9	42.9%	19	59.4%	25	53.2%	46	65.7%	49	57.6%	21	44.7%	23	34.8%	35	33.0%	227	47.9%
男女合計	13	35.1%	32	57.1%	52	51.5%	87	61.7%	76	49.7%	42	46.2%	43	35.0%	77	35.6%	422	46.0%
無回答																		
男性	0	0.0%	0	0.0%	0	0.0%	0	0.0%	2	2.9%	1	2.3%	4	7.0%	6	5.5%	13	2.9%
女性	0	0.0%	0	0.0%	0	0.0%	1	1.4%	1	1.2%	0	0.0%	1	1.5%	8	7.5%	11	2.3%
男女合計	0	0.0%	0	0.0%	0	0.0%	1	0.7%	3	2.0%	1	1.1%	5	4.1%	14	6.5%	24	2.6%
全体(人)																		
男性	16		24		54		71		68		44		57		110		444	
女性	21		32		47		70		85		47		66		106		474	
男女合計	37		56		101		141		153		91		123		216		918	

県 南

	10	割合	20	割合	30	割合	40	割合	50	割合	64	割合	69	割合	70～	割合	全体数	割合
1と回答																		
男性	0	0.0%	0	0.0%	2	16.7%	2	9.5%	5	17.2%	7	33.3%	4	16.0%	20	32.3%	40	21.7%
女性	1	25.0%	0	0.0%	1	10.0%	3	14.3%	1	3.6%	4	16.0%	7	26.9%	22	31.9%	39	20.9%
男女合計	1	20.0%	0	0.0%	3	13.6%	5	11.9%	6	10.5%	11	23.9%	11	21.6%	42	32.1%	79	21.3%
2と回答																		
男性	0	0.0%	1	7.7%	1	8.3%	2	9.5%	4	13.8%	6	28.6%	7	28.0%	10	16.1%	31	16.8%
女性	0	0.0%	0	0.0%	2	20.0%	4	19.0%	4	14.3%	5	20.0%	7	26.9%	13	18.8%	35	18.7%
男女合計	0	0.0%	1	5.9%	3	13.6%	6	14.3%	8	14.0%	11	23.9%	14	27.5%	23	17.6%	66	17.8%
3と回答																		
男性	1	100.0%	2	15.4%	2	16.7%	2	9.5%	2	6.9%	2	9.5%	4	16.0%	13	21.0%	28	15.2%
女性	1	25.0%	0	0.0%	0	0.0%	2	9.5%	5	17.9%	4	16.0%	6	23.1%	11	15.9%	29	15.5%
男女合計	2	40.0%	2	11.8%	2	9.1%	4	9.5%	7	12.3%	6	13.0%	10	19.6%	24	18.3%	57	15.4%
4と回答																		
男性	0	0.0%	10	76.9%	6	50.0%	15	71.4%	18	62.1%	6	28.6%	9	36.0%	17	27.4%	81	44.0%
女性	2	50.0%	4	100.0%	7	70.0%	12	57.1%	17	60.7%	12	48.0%	5	19.2%	20	29.0%	79	42.2%
男女合計	2	40.0%	14	82.4%	13	59.1%	27	64.3%	35	61.4%	18	39.1%	14	27.5%	37	28.2%	160	43.1%
無回答																		
男性	0	0.0%	0	0.0%	1	8.3%	0	0.0%	0	0.0%	0	0.0%	1	4.0%	2	3.2%	4	2.2%
女性	0	0.0%	0	0.0%	0	0.0%	0	0.0%	1	3.6%	0	0.0%	1	3.8%	3	4.3%	5	2.7%
男女合計	0	0.0%	0	0.0%	1	4.5%	0	0.0%	1	1.8%	0	0.0%	2	3.9%	5	3.8%	9	2.4%
全体(人)																		
男性	1		13		12		21		29		21		25		62		184	
女性	4		4		10		21		28		25		26		69		187	
男女合計	5		17		22		42		57		46		51		131		371	

会 津

	10	割合	20	割合	30	割合	40	割合	50	割合	64	割合	69	割合	70～	割合	全体数	割合
1と回答																		
男性	4	33.3%	1	7.7%	0	0.0%	2	8.0%	5	15.6%	6	17.1%	6	18.2%	22	18.5%	46	15.9%
女性	1	20.0%	0	0.0%	1	4.5%	2	7.4%	3	8.1%	5	15.6%	8	25.0%	16	12.3%	36	12.0%
男女合計	5	29.4%	1	3.7%	1	2.4%	4	7.7%	8	11.6%	11	16.4%	14	21.5%	38	15.3%	82	13.9%
2と回答																		
男性	4	33.3%	2	15.4%	3	15.0%	4	16.0%	2	6.3%	4	11.4%	12	36.4%	32	26.9%	63	21.8%
女性	2	40.0%	1	7.1%	3	13.6%	4	14.8%	10	27.0%	4	12.5%	8	25.0%	39	30.0%	71	23.7%
男女合計	6	35.3%	3	11.1%	6	14.3%	8	15.4%	12	17.4%	8	11.9%	20	30.8%	71	28.5%	134	22.8%
3と回答																		
男性	2	16.7%	3	23.1%	6	30.0%	5	20.0%	4	12.5%	7	20.0%	2	6.1%	16	13.4%	45	15.6%
女性	1	20.0%	5	35.7%	2	9.1%	2	7.4%	3	8.1%	10	31.3%	5	15.6%	16	12.3%	44	14.7%
男女合計	3	17.6%	8	29.6%	8	19.0%	7	13.5%	7	10.1%	17	25.4%	7	10.8%	32	12.9%	89	15.1%
4と回答																		
男性	2	16.7%	7	53.8%	9	45.0%	12	48.0%	20	62.5%	16	45.7%	13	39.4%	45	37.8%	124	42.9%
女性	1	20.0%	7	50.0%	16	72.7%	18	66.7%	19	51.4%	13	40.6%	11	34.4%	52	40.0%	137	45.8%
男女合計	3	17.6%	14	51.9%	25	59.5%	30	57.7%	39	56.5%	29	43.3%	24	36.9%	97	39.0%	261	44.4%
無回答																		
男性	0	0.0%	0	0.0%	2	10.0%	2	8.0%	1	3.1%	2	5.7%	0	0.0%	4	3.4%	11	3.8%
女性	0	0.0%	1	7.1%	0	0.0%	1	3.7%	2	5.4%	0	0.0%	0	0.0%	7	5.4%	11	3.7%
男女合計	0	0.0%	1	3.7%	2	4.8%	3	5.8%	3	4.3%	2	3.0%	0	0.0%	11	4.4%	22	3.7%
全体(人)																		
男性	12		13		20		25		32		35		33		119		289	
女性	5		14		22		27		37		32		32		130		299	
男女合計	17		27		42		52		69		67		65		249		588	

南 会 津

	10	割合	20	割合	30	割合	40	割合	50	割合	64	割合	69	割合	70～	割合	全体数	割合
1と回答																		
男性	1	50.0%	1	50.0%	0	0.0%	0	0.0%	0	0.0%	1	33.3%	0	0.0%	4	20.0%	7	18.4%
女性	0	0.0%	0	0.0%	0	0.0%	0	0.0%	0	0.0%	0	0.0%	0	0.0%	3	20.0%	3	8.6%
男女合計	1	20.0%	1	50.0%	0	0.0%	0	0.0%	0	0.0%	1	20.0%	0	0.0%	7	20.0%	10	13.7%
2と回答																		
男性	0	0.0%	1	50.0%	0	0.0%	0	0.0%	1	33.3%	0	0.0%	1	25.0%	3	15.0%	6	15.8%
女性	0	0.0%	0	0.0%	0	0.0%	3	60.0%	0	0.0%	0	0.0%	0	0.0%	4	26.7%	7	20.0%
男女合計	0	0.0%	1	50.0%	0	0.0%	3	37.5%	1	16.7%	0	0.0%	1	10.0%	7	20.0%	13	17.8%
3と回答																		
男性	0	0.0%	0	0.0%	1	100.0%	0	0.0%	0	0.0%	1	33.3%	0	0.0%	2	10.0%	4	10.5%
女性	0	0.0%	0	0.0%	0	0.0%	0	0.0%	1	33.3%	2	100.0%	2	33.3%	4	26.7%	9	25.7%
男女合計	0	0.0%	0	0.0%	1	50.0%	0	0.0%	1	16.7%	3	60.0%	2	20.0%	6	17.1%	13	17.8%
4と回答																		
男性	1	50.0%	0	0.0%	0	0.0%	3	100.0%	2	66.7%	1	33.3%	3	75.0%	11	55.0%	21	55.3%
女性	3	100.0%	0	0.0%	1	100.0%	2	40.0%	2	66.7%	0	0.0%	4	66.7%	4	26.7%	16	45.7%
男女合計	4	80.0%	0	0.0%	1	50.0%	5	62.5%	4	66.7%	1	20.0%	7	70.0%	15	42.9%	37	50.7%
無回答																		
男性	0	0.0%	0	0.0%	0	0.0%	0	0.0%	0	0.0%	0	0.0%	0	0.0%	0	0.0%	0	0.0%
女性	0	0.0%	0	0.0%	0	0.0%	0	0.0%	0	0.0%	0	0.0%	0	0.0%	0	0.0%	0	0.0%
男女合計	0	0.0%	0	0.0%	0	0.0%	0	0.0%	0	0.0%	0	0.0%	0	0.0%	0	0.0%	0	0.0%
全体(人)																		
男性	2		2		1		3		3		3		4		20		38	
女性	3		0		1		5		3		2		6		15		35	
男女合計	5		2		2		8		6		5		10		35		73	

相 双

	10	割合	20	割合	30	割合	40	割合	50	割合	64	割合	69	割合	70～	割合	全体数	割合
1と回答																		
男性	2	50.0%	1	11.1%	1	10.0%	0	0.0%	1	8.3%	4	30.8%	2	8.0%	11	28.2%	22	18.3%
女性	0	0.0%	0	0.0%	0	0.0%	0	0.0%	0	0.0%	0	0.0%	5	21.7%	11	22.9%	16	12.1%
男女合計	2	40.0%	1	7.1%	1	5.6%	0	0.0%	1	3.0%	4	14.3%	7	14.6%	22	25.3%	38	15.1%
2と回答																		
男性	1	25.0%	0	0.0%	2	20.0%	1	12.5%	2	16.7%	3	23.1%	10	40.0%	10	25.6%	29	24.2%
女性	0	0.0%	1	20.0%	0	0.0%	2	18.2%	5	23.8%	2	13.3%	6	26.1%	10	20.8%	26	19.7%
男女合計	1	20.0%	1	7.1%	2	11.1%	3	15.8%	7	21.2%	5	17.9%	16	33.3%	20	23.0%	55	21.8%
3と回答																		
男性	0	0.0%	4	44.4%	4	40.0%	2	25.0%	3	25.0%	1	7.7%	4	16.0%	7	17.9%	25	20.8%
女性	0	0.0%	0	0.0%	1	12.5%	3	27.3%	5	23.8%	2	13.3%	4	17.4%	14	29.2%	29	22.0%
男女合計	0	0.0%	4	28.6%	5	27.8%	5	26.3%	8	24.2%	3	10.7%	8	16.7%	21	24.1%	54	21.4%
4と回答																		
男性	1	25.0%	4	44.4%	3	30.0%	3	37.5%	6	50.0%	5	38.5%	7	28.0%	10	25.6%	39	32.5%
女性	1	100.0%	4	80.0%	7	87.5%	5	45.5%	11	52.4%	10	66.7%	8	34.8%	10	20.8%	56	42.4%
男女合計	2	40.0%	8	57.1%	10	55.6%	8	42.1%	17	51.5%	15	53.6%	15	31.3%	20	23.0%	95	37.7%
無回答																		
男性	0	0.0%	0	0.0%	0	0.0%	2	25.0%	0	0.0%	0	0.0%	2	8.0%	1	2.6%	5	4.2%
女性	0	0.0%	0	0.0%	0	0.0%	1	9.1%	0	0.0%	1	6.7%	0	0.0%	3	6.3%	5	3.8%
男女合計	0	0.0%	0	0.0%	0	0.0%	3	15.8%	0	0.0%	1	3.6%	2	4.2%	4	4.6%	10	4.0%
全体(人)																		
男性	4		9		10		8		12		13		25		39		120	
女性	1		5		8		11		21		15		23		48		132	
男女合計	5		14		18		19		33		28		48		87		252	

いわき

	10	割合	20	割合	30	割合	40	割合	50	割合	64	割合	69	割合	70～	割合	全体数	割合
1と回答																		
男性	6	50.0%	5	23.8%	4	7.8%	3	5.6%	3	6.1%	4	16.0%	6	16.2%	33	33.3%	64	18.4%
女性	2	18.2%	1	4.5%	3	7.5%	4	7.4%	8	14.0%	1	3.1%	6	16.7%	24	19.8%	49	13.1%
男女合計	8	34.8%	6	14.0%	7	7.7%	7	6.5%	11	10.4%	5	8.8%	12	16.4%	57	25.9%	113	15.7%
2と回答																		
男性	2	16.7%	5	23.8%	9	17.6%	6	11.1%	8	16.3%	7	28.0%	8	21.6%	20	20.2%	65	18.7%
女性	3	27.3%	5	22.7%	4	10.0%	2	3.7%	14	24.6%	10	31.3%	13	36.1%	32	26.4%	83	22.3%
男女合計	5	21.7%	10	23.3%	13	14.3%	8	7.4%	22	20.8%	17	29.8%	21	28.8%	52	23.6%	148	20.5%
3と回答																		
男性	0	0.0%	5	23.8%	10	19.6%	9	16.7%	8	16.3%	5	20.0%	9	24.3%	11	11.1%	57	16.4%
女性	0	0.0%	3	13.6%	6	15.0%	5	9.3%	10	17.5%	5	15.6%	5	13.9%	22	18.2%	56	15.0%
男女合計	0	0.0%	8	18.6%	16	17.6%	14	13.0%	18	17.0%	10	17.5%	14	19.2%	33	15.0%	113	15.7%
4と回答																		
男性	4	33.3%	5	23.8%	27	52.9%	35	64.8%	29	59.2%	9	36.0%	14	37.8%	30	30.3%	153	44.0%
女性	5	45.5%	11	50.0%	27	67.5%	42	77.8%	23	40.4%	15	46.9%	11	30.6%	38	31.4%	172	46.1%
男女合計	9	39.1%	16	37.2%	54	59.3%	77	71.3%	52	49.1%	24	42.1%	25	34.2%	68	30.9%	325	45.1%
無回答																		
男性	0	0.0%	1	4.8%	1	2.0%	1	1.9%	1	2.0%	0	0.0%	0	0.0%	5	5.1%	9	2.6%
女性	1	9.1%	2	9.1%	0	0.0%	1	1.9%	2	3.5%	1	3.1%	1	2.8%	5	4.1%	13	3.5%
男女合計	1	4.3%	3	7.0%	1	1.1%	2	1.9%	3	2.8%	1	1.8%	1	1.4%	10	4.5%	22	3.1%
全体(人)																		
男性	12		21		51		54		49		25		37		99		348	
女性	11		22		40		54		57		32		36		121		373	
男女合計	23		43		91		108		106		57		73		220		721	

全県(60歳以上・再掲)

	64	割合	69	割合	70	割合	80	割合	90	割合	全体数	割合
1と回答												
男性	34	17.3%	46	18.8%	92	23.1%	62	30.5%	3	16.7%	237	22.3%
女性	20	9.9%	55	21.6%	90	24.5%	36	14.5%	9	17.0%	210	18.6%
男女合計	54	13.5%	101	20.2%	182	23.8%	98	21.7%	12	16.9%	447	20.4%
2と回答												
男性	39	19.8%	67	27.3%	107	26.9%	31	15.3%	2	11.1%	246	23.2%
女性	49	24.1%	67	26.3%	107	29.1%	56	22.5%	9	17.0%	288	25.5%
男女合計	88	22.0%	134	26.8%	214	27.9%	87	19.2%	11	15.5%	534	24.4%
3と回答												
男性	36	18.3%	38	15.5%	67	16.8%	26	12.8%	4	22.2%	171	16.1%
女性	41	20.2%	49	19.2%	64	17.4%	47	18.9%	5	9.4%	206	18.3%
男女合計	77	19.3%	87	17.4%	131	17.1%	73	16.2%	9	12.7%	377	17.2%
4と回答												
男性	84	42.6%	84	34.3%	122	30.7%	71	35.0%	8	44.4%	369	34.8%
女性	91	44.8%	78	30.6%	91	24.7%	97	39.0%	23	43.4%	380	33.7%
男女合計	175	43.8%	162	32.4%	213	27.8%	168	37.2%	31	43.7%	749	34.2%
無回答												
男性	4	2.0%	10	4.1%	10	2.5%	13	6.4%	1	5.6%	38	3.6%
女性	2	1.0%	6	2.4%	16	4.3%	13	5.2%	7	13.2%	44	3.9%
男女合計	6	1.5%	16	3.2%	26	3.4%	26	5.8%	8	11.3%	82	3.7%
全体(人)												
男性	197		245		398		203		18		1061	
女性	203		255		368		249		53		1128	
男女合計	400		500		766		452		71		2189	

(2) 運動時間 (調査票 問10付問)

付問 問10で1～3を選んだ方におたずねします。1回の運動時間はどのくらいですか。
 複数の運動をしている方は、もっとも運動時間の長いものについてお答えください。

1 15分未満 2 15～30分未満 3 30分以上

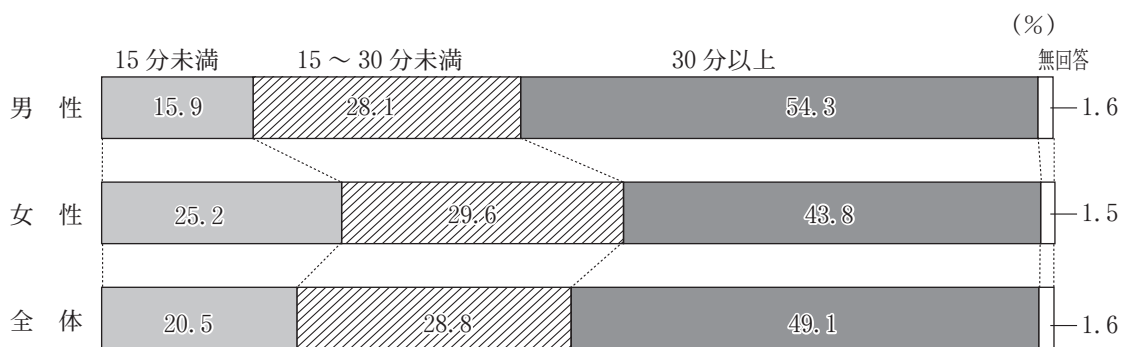

	10	割合	20	割合	30	割合	40	割合	50	割合	64	割合	69	割合	70	割合	80	割合	90	割合	全体数	割合
1と回答																						
男性	2	3.5%	1	1.7%	15	15.3%	17	17.5%	19	14.8%	21	19.3%	23	15.2%	46	17.3%	27	22.7%	3	33.3%	174	15.9%
女性	0	0.0%	6	12.5%	16	27.6%	17	21.0%	41	27.9%	31	28.2%	50	29.2%	56	21.5%	43	30.9%	11	47.8%	271	25.2%
男女合計	2	2.1%	7	6.5%	31	19.9%	34	19.1%	60	21.8%	52	23.7%	73	22.7%	102	19.4%	70	27.1%	14	43.8%	445	20.5%
2と回答																						
男性	7	12.3%	13	22.0%	30	30.6%	30	30.9%	43	33.6%	25	22.9%	38	25.2%	84	31.6%	36	30.3%	1	11.1%	307	28.1%
女性	8	21.1%	18	37.5%	21	36.2%	29	35.8%	39	26.5%	32	29.1%	45	26.3%	72	27.6%	47	33.8%	7	30.4%	318	29.6%
男女合計	15	15.8%	31	29.0%	51	32.7%	59	33.1%	82	29.8%	57	26.0%	83	25.8%	156	29.6%	83	32.2%	8	25.0%	625	28.8%
3と回答																						
男性	48	84.2%	45	76.3%	53	54.1%	50	51.5%	65	50.8%	62	56.9%	89	58.9%	126	47.4%	53	44.5%	3	33.3%	594	54.3%
女性	30	78.9%	24	50.0%	20	34.5%	35	43.2%	67	45.6%	46	41.8%	74	43.3%	127	48.7%	45	32.4%	3	13.0%	471	43.8%
男女合計	78	82.1%	69	64.5%	73	46.8%	85	47.8%	132	48.0%	108	49.3%	163	50.6%	253	48.0%	98	38.0%	6	18.8%	1065	49.1%
無回答																						
男性	0	0.0%	0	0.0%	0	0.0%	0	0.0%	1	0.8%	1	0.9%	1	0.7%	10	3.8%	3	2.5%	2	22.2%	18	1.6%
女性	0	0.0%	0	0.0%	1	1.7%	0	0.0%	0	0.0%	1	0.9%	2	1.2%	6	2.3%	4	2.9%	2	8.7%	16	1.5%
男女合計	0	0.0%	0	0.0%	1	0.6%	0	0.0%	1	0.4%	2	0.9%	3	0.9%	16	3.0%	7	2.7%	4	12.5%	34	1.6%
全体(人)																						
男性	57		59		98		97		128		109		151		266		119		9		1093	
女性	38		48		58		81		147		110		171		261		139		23		1076	
男女合計	95		107		156		178		275		219		322		527		258		32		2169	

県 北

	10	割合	20	割合	30	割合	40	割合	50	割合	64	割合	69	割合	70～	割合	全体数	割合
1と回答																		
男性	1	4.5%	0	0.0%	5	19.2%	4	13.8%	5	12.2%	4	13.8%	6	14.0%	17	14.4%	42	12.9%
女性	0	0.0%	4	21.1%	3	23.1%	6	27.3%	16	37.2%	5	16.7%	17	36.2%	24	20.2%	75	24.4%
男女合計	1	2.7%	4	11.1%	8	20.5%	10	19.6%	21	25.0%	9	15.3%	23	25.6%	41	17.3%	117	18.5%
2と回答																		
男性	0	0.0%	3	17.6%	6	23.1%	8	27.6%	12	29.3%	8	27.6%	14	32.6%	36	30.5%	87	26.8%
女性	1	6.7%	6	31.6%	5	38.5%	6	27.3%	10	23.3%	8	26.7%	15	31.9%	34	28.6%	85	27.6%
男女合計	1	2.7%	9	25.0%	11	28.2%	14	27.5%	22	26.2%	16	27.1%	29	32.2%	70	29.5%	172	27.2%
3と回答																		
男性	21	95.5%	14	82.4%	15	57.7%	17	58.6%	23	56.1%	17	58.6%	23	53.5%	60	50.8%	190	58.5%
女性	14	93.3%	9	47.4%	5	38.5%	10	45.5%	17	39.5%	17	56.7%	15	31.9%	60	50.4%	147	47.7%
男女合計	35	94.6%	23	63.9%	20	51.3%	27	52.9%	40	47.6%	34	57.6%	38	42.2%	120	50.6%	337	53.2%
無回答																		
男性	0	0.0%	0	0.0%	0	0.0%	0	0.0%	1	2.4%	0	0.0%	0	0.0%	5	4.2%	6	1.8%
女性	0	0.0%	0	0.0%	0	0.0%	0	0.0%	0	0.0%	0	0.0%	0	0.0%	1	0.8%	1	0.3%
男女合計	0	0.0%	0	0.0%	0	0.0%	0	0.0%	1	1.2%	0	0.0%	0	0.0%	6	2.5%	7	1.1%
全体(人)																		
男性	22		17		26		29		41		29		43		118		325	
女性	15		19		13		22		43		30		47		119		308	
男女合計	37		36		39		51		84		59		90		237		633	

県 中

	10	割合	20	割合	30	割合	40	割合	50	割合	64	割合	69	割合	70～	割合	全体数	割合
1と回答																		
男性	0	0.0%	0	0.0%	4	14.8%	5	16.7%	5	12.8%	4	18.2%	10	30.3%	10	16.1%	38	16.1%
女性	0	0.0%	0	0.0%	6	27.3%	3	13.0%	7	20.0%	7	26.9%	13	31.0%	21	33.3%	57	24.2%
男女合計	0	0.0%	0	0.0%	10	20.4%	8	15.1%	12	16.2%	11	22.9%	23	30.7%	31	24.8%	95	20.1%
2と回答																		
男性	3	25.0%	2	18.2%	11	40.7%	10	33.3%	13	33.3%	6	27.3%	5	15.2%	18	29.0%	68	28.8%
女性	2	16.7%	7	53.8%	9	40.9%	10	43.5%	12	34.3%	10	38.5%	11	26.2%	19	30.2%	80	33.9%
男女合計	5	20.8%	9	37.5%	20	40.8%	20	37.7%	25	33.8%	16	33.3%	16	21.3%	37	29.6%	148	31.4%
3と回答																		
男性	9	75.0%	9	81.8%	12	44.4%	15	50.0%	21	53.8%	11	50.0%	18	54.5%	32	51.6%	127	53.8%
女性	10	83.3%	6	46.2%	7	31.8%	10	43.5%	16	45.7%	9	34.6%	18	42.9%	21	33.3%	97	41.1%
男女合計	19	79.2%	15	62.5%	19	38.8%	25	47.2%	37	50.0%	20	41.7%	36	48.0%	53	42.4%	224	47.5%
無回答																		
男性	0	0.0%	0	0.0%	0	0.0%	0	0.0%	0	0.0%	1	4.5%	0	0.0%	2	3.2%	3	1.3%
女性	0	0.0%	0	0.0%	0	0.0%	0	0.0%	0	0.0%	0	0.0%	0	0.0%	2	3.2%	2	0.8%
男女合計	0	0.0%	0	0.0%	0	0.0%	0	0.0%	0	0.0%	1	2.1%	0	0.0%	4	3.2%	5	1.1%
全体(人)																		
男性	12		11		27		30		39		22		33		62		236	
女性	12		13		22		23		35		26		42		63		236	
男女合計	24		24		49		53		74		48		75		125		472	

県 南

	10	割合	20	割合	30	割合	40	割合	50	割合	64	割合	69	割合	70～	割合	全体数	割合
1と回答																		
男性	0	0.0%	0	0.0%	2	40.0%	2	33.3%	1	9.1%	2	13.3%	3	20.0%	9	20.9%	19	19.2%
女性	0	0.0%	0	0.0%	1	33.3%	0	0.0%	2	20.0%	5	38.5%	5	25.0%	11	23.9%	24	23.3%
男女合計	0	0.0%	0	0.0%	3	37.5%	2	13.3%	3	14.3%	7	25.0%	8	22.9%	20	22.5%	43	21.3%
2と回答																		
男性	0	0.0%	1	33.3%	1	20.0%	1	16.7%	4	36.4%	2	13.3%	3	20.0%	10	23.3%	22	22.2%
女性	0	0.0%	0	0.0%	1	33.3%	4	44.4%	4	40.0%	5	38.5%	2	10.0%	12	26.1%	28	27.2%
男女合計	0	0.0%	1	33.3%	2	25.0%	5	33.3%	8	38.1%	7	25.0%	5	14.3%	22	24.7%	50	24.8%
3と回答																		
男性	1	100.0%	2	66.7%	2	40.0%	3	50.0%	6	54.5%	11	73.3%	8	53.3%	23	53.5%	56	56.6%
女性	2	100.0%	0	0.0%	1	33.3%	5	55.6%	4	40.0%	2	15.4%	13	65.0%	22	47.8%	49	47.6%
男女合計	3	100.0%	2	66.7%	3	37.5%	8	53.3%	10	47.6%	13	46.4%	21	60.0%	45	50.6%	105	52.0%
無回答																		
男性	0	0.0%	0	0.0%	0	0.0%	0	0.0%	0	0.0%	0	0.0%	1	6.7%	1	2.3%	2	2.0%
女性	0	0.0%	0	0.0%	0	0.0%	0	0.0%	0	0.0%	1	7.7%	0	0.0%	1	2.2%	2	1.9%
男女合計	0	0.0%	0	0.0%	0	0.0%	0	0.0%	0	0.0%	1	3.6%	1	2.9%	2	2.2%	4	2.0%
全体(人)																		
男性	1		3		5		6		11		15		15		43		99	
女性	2		0		3		9		10		13		20		46		103	
男女合計	3		3		8		15		21		28		35		89		202	

会 津

	10	割合	20	割合	30	割合	40	割合	50	割合	64	割合	69	割合	70～	割合	全体数	割合
1と回答																		
男性	0	0.0%	0	0.0%	0	0.0%	3	27.3%	4	36.4%	6	35.3%	2	10.0%	21	30.0%	36	23.4%
女性	0	0.0%	2	33.3%	2	33.3%	1	12.5%	5	31.3%	12	63.2%	6	28.6%	20	28.2%	48	31.8%
男女合計	0	0.0%	2	16.7%	2	13.3%	4	21.1%	9	33.3%	18	50.0%	8	19.5%	41	29.1%	84	27.5%
2と回答																		
男性	3	30.0%	3	50.0%	4	44.4%	4	36.4%	6	54.5%	1	5.9%	6	30.0%	15	21.4%	42	27.3%
女性	2	50.0%	2	33.3%	2	33.3%	2	25.0%	3	18.8%	4	21.1%	3	14.3%	21	29.6%	39	25.8%
男女合計	5	35.7%	5	41.7%	6	40.0%	6	31.6%	9	33.3%	5	13.9%	9	22.0%	36	25.5%	81	26.6%
3と回答																		
男性	7	70.0%	3	50.0%	5	55.6%	4	36.4%	1	9.1%	10	58.8%	12	60.0%	30	42.9%	72	46.8%
女性	2	50.0%	2	33.3%	2	33.3%	5	62.5%	8	50.0%	3	15.8%	11	52.4%	28	39.4%	61	40.4%
男女合計	9	64.3%	5	41.7%	7	46.7%	9	47.4%	9	33.3%	13	36.1%	23	56.1%	58	41.1%	133	43.6%
無回答																		
男性	0	0.0%	0	0.0%	0	0.0%	0	0.0%	0	0.0%	0	0.0%	0	0.0%	4	5.7%	4	2.6%
女性	0	0.0%	0	0.0%	0	0.0%	0	0.0%	0	0.0%	0	0.0%	1	4.8%	2	2.8%	3	2.0%
男女合計	0	0.0%	0	0.0%	0	0.0%	0	0.0%	0	0.0%	0	0.0%	1	2.4%	6	4.3%	7	2.3%
全体(人)																		
男性	10		6		9		11		11		17		20		70		154	
女性	4		6		6		8		16		19		21		71		151	
男女合計	14		12		15		19		27		36		41		141		305	

南 会 津

	10	割合	20	割合	30	割合	40	割合	50	割合	64	割合	69	割合	70～	割合	全体数	割合
1と回答																		
男性	0	0.0%	0	0.0%	0	0.0%	0	0.0%	0	0.0%	0	0.0%	0	0.0%	4	44.4%	4	23.5%
女性	0	0.0%	0	0.0%	0	0.0%	3	100.0%	0	0.0%	0	0.0%	1	50.0%	2	18.2%	6	31.6%
男女合計	0	0.0%	0	0.0%	0	0.0%	3	100.0%	0	0.0%	0	0.0%	1	33.3%	6	30.0%	10	27.8%
2と回答																		
男性	0	0.0%	0	0.0%	0	0.0%	0	0.0%	0	0.0%	2	100.0%	0	0.0%	5	55.6%	7	41.2%
女性	0	0.0%	0	0.0%	0	0.0%	0	0.0%	1	100.0%	1	50.0%	0	0.0%	3	27.3%	5	26.3%
男女合計	0	0.0%	0	0.0%	0	0.0%	0	0.0%	1	50.0%	3	75.0%	0	0.0%	8	40.0%	12	33.3%
3と回答																		
男性	1	100.0%	2	100.0%	1	100.0%	0	0.0%	1	100.0%	0	0.0%	1	100.0%	0	0.0%	6	35.3%
女性	0	0.0%	0	0.0%	0	0.0%	0	0.0%	0	0.0%	1	50.0%	1	50.0%	4	36.4%	6	31.6%
男女合計	1	100.0%	2	100.0%	1	100.0%	0	0.0%	1	50.0%	1	25.0%	2	66.7%	4	20.0%	12	33.3%
無回答																		
男性	0	0.0%	0	0.0%	0	0.0%	0	0.0%	0	0.0%	0	0.0%	0	0.0%	0	0.0%	0	0.0%
女性	0	0.0%	0	0.0%	0	0.0%	0	0.0%	0	0.0%	0	0.0%	0	0.0%	2	18.2%	2	10.5%
男女合計	0	0.0%	0	0.0%	0	0.0%	0	0.0%	0	0.0%	0	0.0%	0	0.0%	2	10.0%	2	5.6%
全体(人)																		
男性	1		2		1		0		1		2		1		9		17	
女性	0		0		0		3		1		2		2		11		19	
男女合計	1		2		1		3		2		4		3		20		36	

相 双

	10	割合	20	割合	30	割合	40	割合	50	割合	64	割合	69	割合	70～	割合	全体数	割合
1と回答																		
男性	0	0.0%	0	0.0%	2	28.6%	0	0.0%	1	16.7%	1	12.5%	0	0.0%	4	14.3%	8	10.5%
女性	0	0.0%	0	0.0%	1	100.0%	1	20.0%	4	40.0%	0	0.0%	3	20.0%	9	25.7%	18	25.4%
男女合計	0	0.0%	0	0.0%	3	37.5%	1	12.5%	5	31.3%	1	8.3%	3	9.7%	13	20.6%	26	17.7%
2と回答																		
男性	0	0.0%	2	40.0%	2	28.6%	1	33.3%	4	66.7%	1	12.5%	2	12.5%	14	50.0%	26	34.2%
女性	0	0.0%	0	0.0%	0	0.0%	2	40.0%	0	0.0%	1	25.0%	4	26.7%	11	31.4%	18	25.4%
男女合計	0	0.0%	2	33.3%	2	25.0%	3	37.5%	4	25.0%	2	16.7%	6	19.4%	25	39.7%	44	29.9%
3と回答																		
男性	3	100.0%	3	60.0%	3	42.9%	2	66.7%	1	16.7%	6	75.0%	14	87.5%	8	28.6%	40	52.6%
女性	0	0.0%	1	100.0%	0	0.0%	2	40.0%	6	60.0%	3	75.0%	7	46.7%	14	40.0%	33	46.5%
男女合計	3	100.0%	4	66.7%	3	37.5%	4	50.0%	7	43.8%	9	75.0%	21	67.7%	22	34.9%	73	49.7%
無回答																		
男性	0	0.0%	0	0.0%	0	0.0%	0	0.0%	0	0.0%	0	0.0%	0	0.0%	2	7.1%	2	2.6%
女性	0	0.0%	0	0.0%	0	0.0%	0	0.0%	0	0.0%	0	0.0%	1	6.7%	1	2.9%	2	2.8%
男女合計	0	0.0%	0	0.0%	0	0.0%	0	0.0%	0	0.0%	0	0.0%	1	3.2%	3	4.8%	4	2.7%
全体(人)																		
男性	3		5		7		3		6		8		16		28		76	
女性	0		1		1		5		10		4		15		35		71	
男女合計	3		6		8		8		16		12		31		63		147	

いわき

	10	割合	20	割合	30	割合	40	割合	50	割合	64	割合	69	割合	70～	割合	全体数	割合
1と回答																		
男性	1	12.5%	1	6.7%	2	8.7%	3	16.7%	3	15.8%	4	25.0%	2	8.7%	11	17.2%	27	14.5%
女性	0	0.0%	0	0.0%	3	23.1%	3	27.3%	7	21.9%	2	12.5%	5	20.8%	23	29.5%	43	22.9%
男女合計	1	7.7%	1	4.2%	5	13.9%	6	20.7%	10	19.6%	6	18.8%	7	14.9%	34	23.9%	70	18.7%
2と回答																		
男性	1	12.5%	2	13.3%	6	26.1%	6	33.3%	4	21.1%	5	31.3%	8	34.8%	23	35.9%	55	29.6%
女性	3	60.0%	3	33.3%	4	30.8%	5	45.5%	9	28.1%	3	18.8%	10	41.7%	26	33.3%	63	33.5%
男女合計	4	30.8%	5	20.8%	10	27.8%	11	37.9%	13	25.5%	8	25.0%	18	38.3%	49	34.5%	118	31.6%
3と回答																		
男性	6	75.0%	12	80.0%	15	65.2%	9	50.0%	12	63.2%	7	43.8%	13	56.5%	29	45.3%	103	55.4%
女性	2	40.0%	6	66.7%	5	38.5%	3	27.3%	16	50.0%	11	68.8%	9	37.5%	26	33.3%	78	41.5%
男女合計	8	61.5%	18	75.0%	20	55.6%	12	41.4%	28	54.9%	18	56.3%	22	46.8%	55	38.7%	181	48.4%
無回答																		
男性	0	0.0%	0	0.0%	0	0.0%	0	0.0%	0	0.0%	0	0.0%	0	0.0%	1	1.6%	1	0.5%
女性	0	0.0%	0	0.0%	1	7.7%	0	0.0%	0	0.0%	0	0.0%	0	0.0%	3	3.8%	4	2.1%
男女合計	0	0.0%	0	0.0%	1	2.8%	0	0.0%	0	0.0%	0	0.0%	0	0.0%	4	2.8%	5	1.3%
全体(人)																		
男性	8		15		23		18		19		16		23		64		186	
女性	5		9		13		11		32		16		24		78		188	
男女合計	13		24		36		29		51		32		47		142		374	

全県(60歳以上・再掲)

	64	割合	69	割合	70	割合	80	割合	90	割合	全体数	割合
1と回答												
男性	21	19.3%	23	15.2%	46	17.3%	27	22.7%	3	33.3%	120	18.3%
女性	31	28.2%	50	29.2%	56	21.5%	43	30.9%	11	47.8%	191	27.1%
男女合計	52	23.7%	73	22.7%	102	19.4%	70	27.1%	14	43.8%	311	22.9%
2と回答												
男性	25	22.9%	38	25.2%	84	31.6%	36	30.3%	1	11.1%	184	28.1%
女性	32	29.1%	45	26.3%	72	27.6%	47	33.8%	7	30.4%	203	28.8%
男女合計	57	26.0%	83	25.8%	156	29.6%	83	32.2%	8	25.0%	387	28.5%
3と回答												
男性	62	56.9%	89	58.9%	126	47.4%	53	44.5%	3	33.3%	333	50.9%
女性	46	41.8%	74	43.3%	127	48.7%	45	32.4%	3	13.0%	295	41.9%
男女合計	108	49.3%	163	50.6%	253	48.0%	98	38.0%	6	18.8%	628	46.2%
無回答												
男性	1	0.9%	1	0.7%	10	3.8%	3	2.5%	2	22.2%	17	2.6%
女性	1	0.9%	2	1.2%	6	2.3%	4	2.9%	2	8.7%	15	2.1%
男女合計	2	0.9%	3	0.9%	16	3.0%	7	2.7%	4	12.5%	32	2.4%
全体(人)												
男性	109		151		266		119		9		654	
女性	110		171		261		139		23		704	
男女合計	219		322		527		258		32		1358	

(3) 運動習慣の状況 (満20歳以上対象)

(「(1) 運動の状況」及び「(2) 運動時間」の回答に関するクロス集計)

	20	割合	30	割合	40	割合	50	割合	64	割合	69	割合	70	割合	80	割合	90	割合	全体数	割合
何らかの運動をほとんど毎日、15分未満している。																				
男性	0	0.0%	6	2.9%	6	2.4%	8	2.9%	9	4.6%	4	1.6%	13	3.3%	10	4.9%	2	11.1%	58	3.0%
女性	0	0.0%	1	0.6%	4	1.6%	5	1.5%	9	4.4%	21	8.2%	25	6.8%	16	6.4%	3	5.7%	84	4.2%
男女合計	0	0.0%	7	1.8%	10	2.0%	13	2.2%	18	4.5%	25	5.0%	38	5.0%	26	5.8%	5	7.0%	142	3.6%
何らかの運動をほとんど毎日、15～30分未満している。																				
男性	2	1.7%	4	1.9%	2	0.8%	13	4.8%	3	1.5%	10	4.1%	35	8.8%	19	9.4%	0	0.0%	88	4.6%
女性	1	0.8%	6	3.5%	6	2.3%	10	3.0%	6	3.0%	13	5.1%	24	6.5%	10	4.0%	4	7.5%	80	4.0%
男女合計	3	1.2%	10	2.6%	8	1.6%	23	3.8%	9	2.3%	23	4.6%	59	7.7%	29	6.4%	4	5.6%	168	4.3%
何らかの運動をほとんど毎日、30分以上している。																				
男性	16	13.3%	8	3.9%	8	3.2%	13	4.8%	22	11.2%	32	13.1%	42	10.6%	31	15.3%	1	5.6%	173	9.0%
女性	3	2.5%	6	3.5%	6	2.3%	11	3.3%	5	2.5%	21	8.2%	41	11.1%	9	3.6%	1	1.9%	103	5.1%
男女合計	19	7.9%	14	3.7%	14	2.8%	24	4.0%	27	6.8%	53	10.6%	83	10.8%	40	8.8%	2	2.8%	276	7.0%
何らかの運動をほとんど毎日している。(時間無回答)																				
男性	0	0.0%	0	0.0%	0	0.0%	0	0.0%	0	0.0%	0	0.0%	2	0.5%	2	1.0%	0	0.0%	4	0.2%
女性	0	0.0%	0	0.0%	0	0.0%	0	0.0%	0	0.0%	0	0.0%	0	0.0%	1	0.4%	1	1.9%	2	0.1%
男女合計	0	0.0%	0	0.0%	0	0.0%	0	0.0%	0	0.0%	0	0.0%	2	0.3%	3	0.7%	1	1.4%	6	0.2%
何らかの運動を週2～4回程度、15分未満している。																				
男性	1	0.8%	4	1.9%	4	1.6%	5	1.8%	5	2.5%	9	3.7%	16	4.0%	7	3.4%	0	0.0%	51	2.7%
女性	3	2.5%	7	4.0%	8	3.1%	13	3.9%	8	3.9%	14	5.5%	15	4.1%	15	6.0%	5	9.4%	88	4.4%
男女合計	4	1.7%	11	2.9%	12	2.4%	18	3.0%	13	3.3%	23	4.6%	31	4.0%	22	4.9%	5	7.0%	139	3.5%
何らかの運動を週2～4回程度、15～30分未満している。																				
男性	4	3.3%	12	5.8%	11	4.3%	14	5.1%	14	7.1%	18	7.3%	27	6.8%	13	6.4%	0	0.0%	113	5.9%
女性	5	4.1%	11	6.4%	8	3.1%	14	4.2%	14	6.9%	22	8.6%	31	8.4%	23	9.2%	2	3.8%	130	6.5%
男女合計	9	3.7%	23	6.1%	19	3.7%	28	4.6%	28	7.0%	40	8.0%	58	7.6%	36	8.0%	2	2.8%	243	6.2%
何らかの運動を週2～4回程度、30分以上している。																				
男性	13	10.8%	23	11.2%	17	6.7%	25	9.2%	20	10.2%	39	15.9%	59	14.8%	10	4.9%	1	5.6%	207	10.8%
女性	11	9.0%	8	4.6%	12	4.7%	32	9.7%	26	12.8%	30	11.8%	56	15.2%	16	6.4%	1	1.9%	192	9.6%
男女合計	24	9.9%	31	8.2%	29	5.7%	57	9.5%	46	11.5%	69	13.8%	115	15.0%	26	5.8%	2	2.8%	399	10.2%
何らかの運動を週2～4回程度している。(時間無回答)																				
男性	0	0.0%	0	0.0%	0	0.0%	1	0.4%	0	0.0%	1	0.4%	5	1.3%	1	0.5%	1	5.6%	9	0.5%
女性	0	0.0%	0	0.0%	0	0.0%	0	0.0%	1	0.5%	1	0.4%	5	1.4%	2	0.8%	1	1.9%	10	0.5%
男女合計	0	0.0%	0	0.0%	0	0.0%	1	0.2%	1	0.3%	2	0.4%	10	1.3%	3	0.7%	2	2.8%	19	0.5%
何らかの運動を週1回程度、15分未満している。																				
男性	0	0.0%	5	2.4%	7	2.8%	6	2.2%	7	3.6%	10	4.1%	17	4.3%	10	4.9%	1	5.6%	63	3.3%
女性	3	2.5%	8	4.6%	5	2.0%	23	6.9%	14	6.9%	15	5.9%	16	4.3%	12	4.8%	3	5.7%	99	4.9%
男女合計	3	1.2%	13	3.4%	12	2.4%	29	4.8%	21	5.3%	25	5.0%	33	4.3%	22	4.9%	4	5.6%	162	4.1%
何らかの運動を週1回程度、15～30分未満している。																				
男性	7	5.8%	14	6.8%	17	6.7%	16	5.9%	8	4.1%	10	4.1%	22	5.5%	4	2.0%	1	5.6%	99	5.2%
女性	12	9.8%	4	2.3%	15	5.9%	15	4.5%	12	5.9%	10	3.9%	17	4.6%	14	5.6%	1	1.9%	100	5.0%
男女合計	19	7.9%	18	4.7%	32	6.3%	31	5.1%	20	5.0%	20	4.0%	39	5.1%	18	4.0%	2	2.8%	199	5.1%
何らかの運動を週1回程度、30分以上している。																				
男性	16	13.3%	22	10.7%	25	9.9%	27	9.9%	20	10.2%	18	7.3%	25	6.3%	12	5.9%	1	5.6%	166	8.7%
女性	10	8.2%	6	3.5%	17	6.6%	24	7.3%	15	7.4%	23	9.0%	30	8.2%	20	8.0%	1	1.9%	146	7.3%
男女合計	26	10.7%	28	7.4%	42	8.3%	51	8.5%	35	8.8%	41	8.2%	55	7.2%	32	7.1%	2	2.8%	312	8.0%
何らかの運動を週1回程度している。(時間無回答)																				
男性	0	0.0%	0	0.0%	0	0.0%	0	0.0%	1	0.5%	0	0.0%	3	0.8%	0	0.0%	1	5.6%	5	0.3%
女性	0	0.0%	1	0.6%	0	0.0%	0	0.0%	0	0.0%	1	0.4%	1	0.3%	1	0.4%	0	0.0%	4	0.2%
男女合計	0	0.0%	1	0.3%	0	0.0%	0	0.0%	1	0.3%	1	0.2%	4	0.5%	1	0.2%	1	1.4%	9	0.2%
ほとんど(まったく)していない。																				
男性	58	48.3%	102	49.5%	147	58.1%	138	50.7%	84	42.6%	84	34.3%	122	30.7%	71	35.0%	8	44.4%	814	42.6%
女性	69	56.6%	112	64.7%	168	65.6%	176	53.2%	91	44.8%	78	30.6%	91	24.7%	97	39.0%	23	43.4%	905	45.0%
男女合計	127	52.5%	214	56.5%	315	61.9%	314	52.1%	175	43.8%	162	32.4%	213	27.8%	168	37.2%	31	43.7%	1719	43.8%
無回答																				
男性	3	2.5%	6	2.9%	9	3.6%	6	2.2%	4	2.0%	10	4.1%	10	2.5%	13	6.4%	1	5.6%	62	3.2%
女性	5	4.1%	3	1.7%	7	2.7%	8	2.4%	2	1.0%	6	2.4%	16	4.3%	13	5.2%	7	13.2%	67	3.3%
男女合計	8	3.3%	9	2.4%	16	3.1%	14	2.3%	6	1.5%	16	3.2%	26	3.4%	26	5.8%	8	11.3%	129	3.3%
全体(人)																				
男性	120		206		253		272		197		245		398		203		18		1912	
女性	122		173		256		331		203		255		368		249		53		2010	
男女合計	242		379		509		603		400		500		766		452		71		3922	

11 喫煙の状況

(1) 喫煙の有無 (満20歳以上対象) (調査票 問11)

問11 あなたは、たばこを吸っていますか。(○は1つ)

- 1 毎日吸う
- 2 時々吸う
- 3 今は吸っていない
- 4 習慣的に吸ったことがない

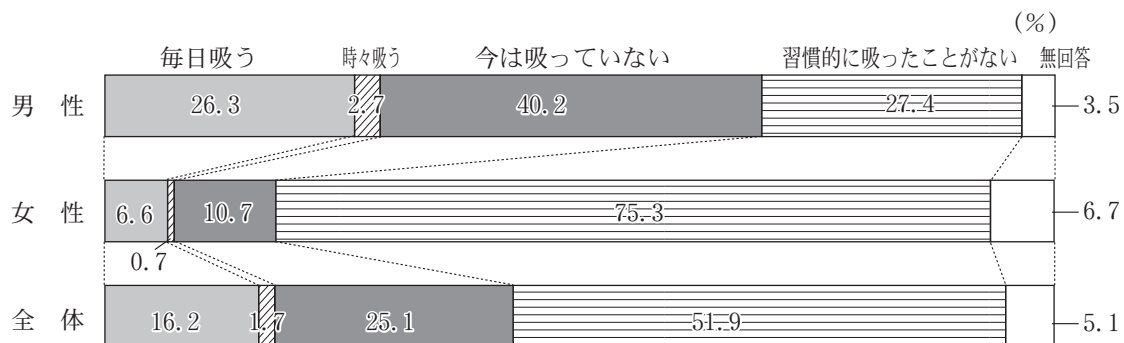

	20	割合	30	割合	40	割合	50	割合	64	割合	69	割合	70	割合	80	割合	90	割合	全体数	割合
1と回答																				
男性	32	26.7%	74	35.9%	95	37.5%	102	37.5%	51	25.9%	58	23.7%	69	17.3%	20	9.9%	1	5.6%	502	26.3%
女性	7	5.7%	26	15.0%	37	14.5%	29	8.8%	10	4.9%	11	4.3%	10	2.7%	2	0.8%	0	0.0%	132	6.6%
男女合計	39	16.1%	100	26.4%	132	25.9%	131	21.7%	61	15.3%	69	13.8%	79	10.3%	22	4.9%	1	1.4%	634	16.2%
2と回答																				
男性	3	2.5%	12	5.8%	12	4.7%	10	3.7%	3	1.5%	4	1.6%	7	1.8%	1	0.5%	0	0.0%	52	2.7%
女性	3	2.5%	4	2.3%	4	1.6%	3	0.9%	1	0.5%	0	0.0%	0	0.0%	0	0.0%	0	0.0%	15	0.7%
男女合計	6	2.5%	16	4.2%	16	3.1%	13	2.2%	4	1.0%	4	0.8%	7	0.9%	1	0.2%	0	0.0%	67	1.7%
3と回答																				
男性	4	3.3%	32	15.5%	67	26.5%	100	36.8%	97	49.2%	129	52.7%	223	56.0%	106	52.2%	10	55.6%	768	40.2%
女性	11	9.0%	35	20.2%	43	16.8%	34	10.3%	21	10.3%	23	9.0%	30	8.2%	14	5.6%	5	9.4%	216	10.7%
男女合計	15	6.2%	67	17.7%	110	21.6%	134	22.2%	118	29.5%	152	30.4%	253	33.0%	120	26.5%	15	21.1%	984	25.1%
4と回答																				
男性	75	62.5%	82	39.8%	67	26.5%	54	19.9%	41	20.8%	46	18.8%	89	22.4%	65	32.0%	4	22.2%	523	27.4%
女性	95	77.9%	105	60.7%	163	63.7%	251	75.8%	166	81.8%	209	82.0%	300	81.5%	188	75.5%	36	67.9%	1513	75.3%
男女合計	170	70.2%	187	49.3%	230	45.2%	305	50.6%	207	51.8%	255	51.0%	389	50.8%	253	56.0%	40	56.3%	2036	51.9%
無回答																				
男性	6	5.0%	6	2.9%	12	4.7%	6	2.2%	5	2.5%	8	3.3%	10	2.5%	11	5.4%	3	16.7%	67	3.5%
女性	6	4.9%	3	1.7%	9	3.5%	14	4.2%	5	2.5%	12	4.7%	28	7.6%	45	18.1%	12	22.6%	134	6.7%
男女合計	12	5.0%	9	2.4%	21	4.1%	20	3.3%	10	2.5%	20	4.0%	38	5.0%	56	12.4%	15	21.1%	201	5.1%
全体(人)																				
男性	120		206		253		272		197		245		398		203		18		1912	
女性	122		173		256		331		203		255		368		249		53		2010	
男女合計	242		379		509		603		400		500		766		452		71		3922	

県 北

	20	割合	30	割合	40	割合	50	割合	64	割合	69	割合	70～	割合	全体数	割合
1と回答																
男性	7	18.4%	23	39.7%	23	32.4%	31	39.2%	10	17.9%	12	18.8%	27	15.9%	133	24.8%
女性	0	0.0%	5	11.1%	6	8.8%	6	6.0%	5	10.0%	1	1.5%	3	1.7%	26	4.7%
男女合計	7	8.4%	28	27.2%	29	20.9%	37	20.7%	15	14.2%	13	10.0%	30	8.5%	159	14.6%
2と回答																
男性	1	2.6%	3	5.2%	5	7.0%	4	5.1%	1	1.8%	1	1.6%	2	1.2%	17	3.2%
女性	0	0.0%	1	2.2%	1	1.5%	1	1.0%	1	2.0%	0	0.0%	0	0.0%	4	0.7%
男女合計	1	1.2%	4	3.9%	6	4.3%	5	2.8%	2	1.9%	1	0.8%	2	0.6%	21	1.9%
3と回答																
男性	1	2.6%	6	10.3%	17	23.9%	25	31.6%	33	58.9%	36	56.3%	93	54.7%	211	39.4%
女性	4	8.9%	8	17.8%	11	16.2%	6	6.0%	4	8.0%	7	10.6%	15	8.3%	55	9.9%
男女合計	5	6.0%	14	13.6%	28	20.1%	31	17.3%	37	34.9%	43	33.1%	108	30.8%	266	24.4%
4と回答																
男性	28	73.7%	24	41.4%	21	29.6%	17	21.5%	11	19.6%	13	20.3%	41	24.1%	155	28.9%
女性	38	84.4%	28	62.2%	47	69.1%	83	83.0%	38	76.0%	53	80.3%	141	77.9%	428	77.1%
男女合計	66	79.5%	52	50.5%	68	48.9%	100	55.9%	49	46.2%	66	50.8%	182	51.9%	583	53.4%
無回答																
男性	1	2.6%	2	3.4%	5	7.0%	2	2.5%	1	1.8%	2	3.1%	7	4.1%	20	3.7%
女性	3	6.7%	3	6.7%	3	4.4%	4	4.0%	2	4.0%	5	7.6%	22	12.2%	42	7.6%
男女合計	4	4.8%	5	4.9%	8	5.8%	6	3.4%	3	2.8%	7	5.4%	29	8.3%	62	5.7%
全体(人)																
男性	38		58		71		79		56		64		170		536	
女性	45		45		68		100		50		66		181		555	
男女合計	83		103		139		179		106		130		351		1091	

県 中

	20	割合	30	割合	40	割合	50	割合	64	割合	69	割合	70～	割合	全体数	割合
1と回答																
男性	5	20.8%	17	31.5%	29	40.8%	23	33.8%	13	29.5%	12	21.1%	16	14.5%	115	26.9%
女性	4	12.5%	5	10.6%	9	12.9%	11	12.9%	1	2.1%	2	3.0%	1	0.9%	33	7.3%
男女合計	9	16.1%	22	21.8%	38	27.0%	34	22.2%	14	15.4%	14	11.4%	17	7.9%	148	16.8%
2と回答																
男性	1	4.2%	4	7.4%	3	4.2%	3	4.4%	1	2.3%	1	1.8%	2	1.8%	15	3.5%
女性	1	3.1%	0	0.0%	1	1.4%	0	0.0%	0	0.0%	0	0.0%	0	0.0%	2	0.4%
男女合計	2	3.6%	4	4.0%	4	2.8%	3	2.0%	1	1.1%	1	0.8%	2	0.9%	17	1.9%
3と回答																
男性	0	0.0%	6	11.1%	21	29.6%	24	35.3%	19	43.2%	32	56.1%	59	53.6%	161	37.6%
女性	2	6.3%	11	23.4%	11	15.7%	10	11.8%	3	6.4%	5	7.6%	5	4.7%	47	10.4%
男女合計	2	3.6%	17	16.8%	32	22.7%	34	22.2%	22	24.2%	37	30.1%	64	29.6%	208	23.6%
4と回答																
男性	15	62.5%	26	48.1%	18	25.4%	17	25.0%	10	22.7%	9	15.8%	29	26.4%	124	29.0%
女性	25	78.1%	31	66.0%	46	65.7%	60	70.6%	43	91.5%	57	86.4%	83	78.3%	345	76.2%
男女合計	40	71.4%	57	56.4%	64	45.4%	77	50.3%	53	58.2%	66	53.7%	112	51.9%	469	53.2%
無回答																
男性	3	12.5%	1	1.9%	0	0.0%	1	1.5%	1	2.3%	3	5.3%	4	3.6%	13	3.0%
女性	0	0.0%	0	0.0%	3	4.3%	4	4.7%	0	0.0%	2	3.0%	17	16.0%	26	5.7%
男女合計	3	5.4%	1	1.0%	3	2.1%	5	3.3%	1	1.1%	5	4.1%	21	9.7%	39	4.4%
全体(人)																
男性	24		54		71		68		44		57		110		428	
女性	32		47		70		85		47		66		106		453	
男女合計	56		101		141		153		91		123		216		881	

県 南

	20	割合	30	割合	40	割合	50	割合	64	割合	69	割合	70～	割合	全体数	割合
1と回答																
男性	5	38.5%	3	25.0%	6	28.6%	11	37.9%	4	19.0%	7	28.0%	7	11.3%	43	23.5%
女性	0	0.0%	2	20.0%	5	23.8%	3	10.7%	1	4.0%	1	3.8%	1	1.4%	13	7.1%
男女合計	5	29.4%	5	22.7%	11	26.2%	14	24.6%	5	10.9%	8	15.7%	8	6.1%	56	15.3%
2と回答																
男性	0	0.0%	0	0.0%	0	0.0%	1	3.4%	0	0.0%	1	4.0%	0	0.0%	2	1.1%
女性	0	0.0%	1	10.0%	0	0.0%	0	0.0%	0	0.0%	0	0.0%	0	0.0%	1	0.5%
男女合計	0	0.0%	1	4.5%	0	0.0%	1	1.8%	0	0.0%	1	2.0%	0	0.0%	3	0.8%
3と回答																
男性	0	0.0%	4	33.3%	6	28.6%	15	51.7%	10	47.6%	10	40.0%	38	61.3%	83	45.4%
女性	0	0.0%	2	20.0%	3	14.3%	2	7.1%	0	0.0%	4	15.4%	0	0.0%	11	6.0%
男女合計	0	0.0%	6	27.3%	9	21.4%	17	29.8%	10	21.7%	14	27.5%	38	29.0%	94	25.7%
4と回答																
男性	8	61.5%	5	41.7%	9	42.9%	1	3.4%	7	33.3%	6	24.0%	17	27.4%	53	29.0%
女性	4	100.0%	5	50.0%	13	61.9%	21	75.0%	22	88.0%	19	73.1%	63	91.3%	147	80.3%
男女合計	12	70.6%	10	45.5%	22	52.4%	22	38.6%	29	63.0%	25	49.0%	80	61.1%	200	54.6%
無回答																
男性	0	0.0%	0	0.0%	0	0.0%	1	3.4%	0	0.0%	1	4.0%	0	0.0%	2	1.1%
女性	0	0.0%	0	0.0%	0	0.0%	2	7.1%	2	8.0%	2	7.7%	5	7.2%	11	6.0%
男女合計	0	0.0%	0	0.0%	0	0.0%	3	5.3%	2	4.3%	3	5.9%	5	3.8%	13	3.6%
全体(人)																
男性	13		12		21		29		21		25		62		183	
女性	4		10		21		28		25		26		69		183	
男女合計	17		22		42		57		46		51		131		366	

会 津

	20	割合	30	割合	40	割合	50	割合	64	割合	69	割合	70～	割合	全体数	割合
1と回答																
男 性	3	23.1%	4	20.0%	9	36.0%	14	43.8%	12	34.3%	6	18.2%	21	17.6%	69	24.9%
女 性	2	14.3%	6	27.3%	5	18.5%	1	2.7%	1	3.1%	3	9.4%	3	2.3%	21	7.1%
男女合計	5	18.5%	10	23.8%	14	26.9%	15	21.7%	13	19.4%	9	13.8%	24	9.6%	90	15.8%
2と回答																
男 性	0	0.0%	2	10.0%	0	0.0%	0	0.0%	0	0.0%	1	3.0%	3	2.5%	6	2.2%
女 性	0	0.0%	1	4.5%	0	0.0%	1	2.7%	0	0.0%	0	0.0%	0	0.0%	2	0.7%
男女合計	0	0.0%	3	7.1%	0	0.0%	1	1.4%	0	0.0%	1	1.5%	3	1.2%	8	1.4%
3と回答																
男 性	1	7.7%	3	15.0%	9	36.0%	15	46.9%	13	37.1%	19	57.6%	67	56.3%	127	45.8%
女 性	2	14.3%	3	13.6%	4	14.8%	5	13.5%	7	21.9%	3	9.4%	19	14.6%	43	14.6%
男女合計	3	11.1%	6	14.3%	13	25.0%	20	29.0%	20	29.9%	22	33.8%	86	34.5%	170	29.8%
4と回答																
男 性	9	69.2%	9	45.0%	4	16.0%	2	6.3%	9	25.7%	7	21.2%	23	19.3%	63	22.7%
女 性	9	64.3%	12	54.5%	17	63.0%	27	73.0%	24	75.0%	25	78.1%	90	69.2%	204	69.4%
男女合計	18	66.7%	21	50.0%	21	40.4%	29	42.0%	33	49.3%	32	49.2%	113	45.4%	267	46.8%
無回答																
男 性	0	0.0%	2	10.0%	3	12.0%	1	3.1%	1	2.9%	0	0.0%	5	4.2%	12	4.3%
女 性	1	7.1%	0	0.0%	1	3.7%	3	8.1%	0	0.0%	1	3.1%	18	13.8%	24	8.2%
男女合計	1	3.7%	2	4.8%	4	7.7%	4	5.8%	1	1.5%	1	1.5%	23	9.2%	36	6.3%
全体(人)																
男 性	13		20		25		32		35		33		119		277	
女 性	14		22		27		37		32		32		130		294	
男女合計	27		42		52		69		67		65		249		571	

南 会 津

	20	割合	30	割合	40	割合	50	割合	64	割合	69	割合	70～	割合	全体数	割合
1と回答																
男 性	0	0.0%	1	100.0%	0	0.0%	1	33.3%	0	0.0%	1	25.0%	1	5.0%	4	11.1%
女 性	0	0.0%	0	0.0%	1	20.0%	1	33.3%	0	0.0%	0	0.0%	0	0.0%	2	6.3%
男女合計	0	0.0%	1	50.0%	1	12.5%	2	33.3%	0	0.0%	1	10.0%	1	2.9%	6	8.8%
2と回答																
男 性	0	0.0%	0	0.0%	0	0.0%	0	0.0%	0	0.0%	0	0.0%	0	0.0%	0	0.0%
女 性	0	0.0%	0	0.0%	0	0.0%	0	0.0%	0	0.0%	0	0.0%	0	0.0%	0	0.0%
男女合計	0	0.0%	0	0.0%	0	0.0%	0	0.0%	0	0.0%	0	0.0%	0	0.0%	0	0.0%
3と回答																
男 性	0	0.0%	0	0.0%	1	33.3%	1	33.3%	2	66.7%	2	50.0%	11	55.0%	17	47.2%
女 性	0	0.0%	0	0.0%	1	20.0%	0	0.0%	0	0.0%	1	16.7%	0	0.0%	2	6.3%
男女合計	0	0.0%	0	0.0%	2	25.0%	1	16.7%	2	40.0%	3	30.0%	11	31.4%	19	27.9%
4と回答																
男 性	2	100.0%	0	0.0%	2	66.7%	1	33.3%	0	0.0%	1	25.0%	8	40.0%	14	38.9%
女 性	0	0.0%	1	100.0%	3	60.0%	2	66.7%	1	50.0%	5	83.3%	10	66.7%	22	68.8%
男女合計	2	100.0%	1	50.0%	5	62.5%	3	50.0%	1	20.0%	6	60.0%	18	51.4%	36	52.9%
無回答																
男 性	0	0.0%	0	0.0%	0	0.0%	0	0.0%	1	33.3%	0	0.0%	0	0.0%	1	2.8%
女 性	0	0.0%	0	0.0%	0	0.0%	0	0.0%	1	50.0%	0	0.0%	5	33.3%	6	18.8%
男女合計	0	0.0%	0	0.0%	0	0.0%	0	0.0%	2	40.0%	0	0.0%	5	14.3%	7	10.3%
全体(人)																
男 性	2		1		3		3		3		4		20		36	
女 性	0		1		5		3		2		6		15		32	
男女合計	2		2		8		6		5		10		35		68	

相 双

	20	割合	30	割合	40	割合	50	割合	64	割合	69	割合	70～	割合	全体数	割合
1と回答																
男 性	6	66.7%	3	30.0%	6	75.0%	5	41.7%	4	30.8%	6	24.0%	1	2.6%	31	26.7%
女 性	1	20.0%	2	25.0%	1	9.1%	1	4.8%	0	0.0%	1	4.3%	3	6.3%	9	6.9%
男女合計	7	50.0%	5	27.8%	7	36.8%	6	18.2%	4	14.3%	7	14.6%	4	4.6%	40	16.2%
2と回答																
男 性	0	0.0%	1	10.0%	0	0.0%	1	8.3%	1	7.7%	0	0.0%	0	0.0%	3	2.6%
女 性	0	0.0%	0	0.0%	0	0.0%	0	0.0%	0	0.0%	0	0.0%	0	0.0%	0	0.0%
男女合計	0	0.0%	1	5.6%	0	0.0%	1	3.0%	1	3.6%	0	0.0%	0	0.0%	3	1.2%
3と回答																
男 性	0	0.0%	2	20.0%	0	0.0%	4	33.3%	7	53.8%	13	52.0%	23	59.0%	49	42.2%
女 性	1	20.0%	1	12.5%	2	18.2%	2	9.5%	2	13.3%	1	4.3%	1	2.1%	10	7.6%
男女合計	1	7.1%	3	16.7%	2	10.5%	6	18.2%	9	32.1%	14	29.2%	24	27.6%	59	23.9%
4と回答																
男 性	3	33.3%	4	40.0%	0	0.0%	2	16.7%	0	0.0%	4	16.0%	15	38.5%	28	24.1%
女 性	3	60.0%	5	62.5%	7	63.6%	18	85.7%	13	86.7%	20	87.0%	41	85.4%	107	81.7%
男女合計	6	42.9%	9	50.0%	7	36.8%	20	60.6%	13	46.4%	24	50.0%	56	64.4%	135	54.7%
無回答																
男 性	0	0.0%	0	0.0%	2	25.0%	0	0.0%	1	7.7%	2	8.0%	0	0.0%	5	4.3%
女 性	0	0.0%	0	0.0%	1	9.1%	0	0.0%	0	0.0%	1	4.3%	3	6.3%	5	3.8%
男女合計	0	0.0%	0	0.0%	3	15.8%	0	0.0%	1	3.6%	3	6.3%	3	3.4%	10	4.0%
全体(人)																
男 性	9		10		8		12		13		25		39		116	
女 性	5		8		11		21		15		23		48		131	
男女合計	14		18		19		33		28		48		87		247	

いわき

	20	割合	30	割合	40	割合	50	割合	64	割合	69	割合	70～	割合	全体数	割合
1と回答																
男性	6	28.6%	23	45.1%	22	40.7%	17	34.7%	8	32.0%	14	37.8%	17	17.2%	107	31.8%
女性	0	0.0%	6	15.0%	10	18.5%	6	10.5%	2	6.3%	3	8.3%	1	0.8%	28	7.7%
男女合計	6	14.0%	29	31.9%	32	29.6%	23	21.7%	10	17.5%	17	23.3%	18	8.2%	135	19.3%
2と回答																
男性	1	4.8%	2	3.9%	4	7.4%	1	2.0%	0	0.0%	0	0.0%	1	1.0%	9	2.7%
女性	2	9.1%	1	2.5%	2	3.7%	1	1.8%	0	0.0%	0	0.0%	0	0.0%	6	1.7%
男女合計	3	7.0%	3	3.3%	6	5.6%	2	1.9%	0	0.0%	0	0.0%	1	0.5%	15	2.1%
3と回答																
男性	2	9.5%	11	21.6%	13	24.1%	16	32.7%	13	52.0%	17	45.9%	48	48.5%	120	35.7%
女性	2	9.1%	10	25.0%	11	20.4%	9	15.8%	5	15.6%	2	5.6%	9	7.4%	48	13.3%
男女合計	4	9.3%	21	23.1%	24	22.2%	25	23.6%	18	31.6%	19	26.0%	57	25.9%	168	24.1%
4と回答																
男性	10	47.6%	14	27.5%	13	24.1%	14	28.6%	4	16.0%	6	16.2%	25	25.3%	86	25.6%
女性	16	72.7%	23	57.5%	30	55.6%	40	70.2%	25	78.1%	30	83.3%	96	79.3%	260	71.8%
男女合計	26	60.5%	37	40.7%	43	39.8%	54	50.9%	29	50.9%	36	49.3%	121	55.0%	346	49.6%
無回答																
男性	2	9.5%	1	2.0%	2	3.7%	1	2.0%	0	0.0%	0	0.0%	8	8.1%	14	4.2%
女性	2	9.1%	0	0.0%	1	1.9%	1	1.8%	0	0.0%	1	2.8%	15	12.4%	20	5.5%
男女合計	4	9.3%	1	1.1%	3	2.8%	2	1.9%	0	0.0%	1	1.4%	23	10.5%	34	4.9%
全体(人)																
男性	21		51		54		49		25		37		99		336	
女性	22		40		54		57		32		36		121		362	
男女合計	43		91		108		106		57		73		220		698	

(2) 禁煙の意思 (調査票 問11付問)

付問 問11で1～2を選んだ方におたずねします。あなたは、たばこをやめたいと思いますか。(○は1つ)

- 1 やめたい 2 本数を減らしたい
3 やめたくない 4 わからない

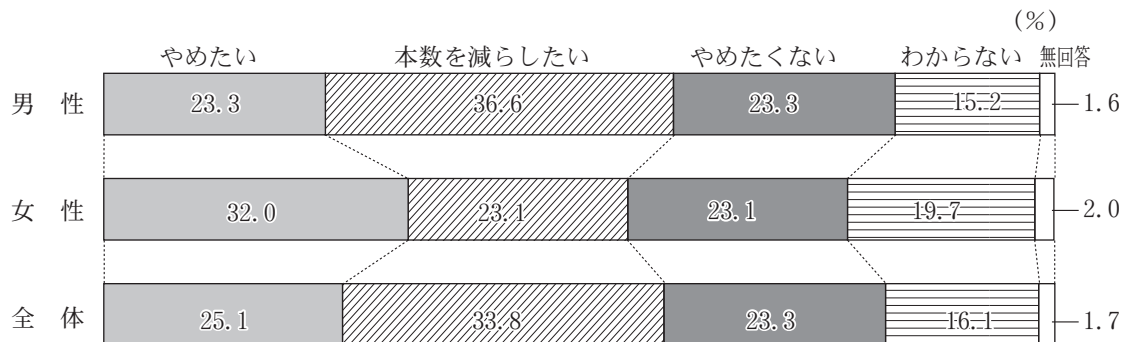

	20	割合	30	割合	40	割合	50	割合	64	割合	69	割合	70	割合	80	割合	90	割合	全体数	割合
1と回答																				
男性	6	17.1%	19	22.1%	26	24.3%	25	22.3%	10	18.5%	14	22.6%	20	26.3%	9	42.9%	0	0.0%	129	23.3%
女性	3	30.0%	12	40.0%	11	26.8%	8	25.0%	4	36.4%	4	36.4%	5	50.0%	0	0.0%	0	0.0%	47	32.0%
男女合計	9	20.0%	31	26.7%	37	25.0%	33	22.9%	14	21.5%	18	24.7%	25	29.1%	9	39.1%	0	0.0%	176	25.1%
2と回答																				
男性	13	37.1%	29	33.7%	28	26.2%	43	38.4%	24	44.4%	35	56.5%	26	34.2%	5	23.8%	0	0.0%	203	36.6%
女性	3	30.0%	4	13.3%	9	22.0%	8	25.0%	2	18.2%	4	36.4%	3	30.0%	1	50.0%	0	0.0%	34	23.1%
男女合計	16	35.6%	33	28.4%	37	25.0%	51	35.4%	26	40.0%	39	53.4%	29	33.7%	6	26.1%	0	0.0%	237	33.8%
3と回答																				
男性	6	17.1%	14	16.3%	32	29.9%	28	25.0%	11	20.4%	11	17.7%	21	27.6%	6	28.6%	0	0.0%	129	23.3%
女性	3	30.0%	5	16.7%	12	29.3%	6	18.8%	3	27.3%	2	18.2%	2	20.0%	1	50.0%	0	0.0%	34	23.1%
男女合計	9	20.0%	19	16.4%	44	29.7%	34	23.6%	14	21.5%	13	17.8%	23	26.7%	7	30.4%	0	0.0%	163	23.3%
4と回答																				
男性	10	28.6%	22	25.6%	20	18.7%	15	13.4%	6	11.1%	1	1.6%	9	11.8%	1	4.8%	0	0.0%	84	15.2%
女性	1	10.0%	7	23.3%	9	22.0%	9	28.1%	2	18.2%	1	9.1%	0	0.0%	0	0.0%	0	0.0%	29	19.7%
男女合計	11	24.4%	29	25.0%	29	19.6%	24	16.7%	8	12.3%	2	2.7%	9	10.5%	1	4.3%	0	0.0%	113	16.1%
無回答																				
男性	0	0.0%	2	2.3%	1	0.9%	1	0.9%	3	5.6%	1	1.6%	0	0.0%	0	0.0%	1	100.0%	9	1.6%
女性	0	0.0%	2	6.7%	0	0.0%	1	3.1%	0	0.0%	0	0.0%	0	0.0%	0	0.0%	0	0.0%	3	2.0%
男女合計	0	0.0%	4	3.4%	1	0.7%	2	1.4%	3	4.6%	1	1.4%	0	0.0%	0	0.0%	1	100.0%	12	1.7%
全体(人)																				
男性	35	86	107	112	54	62	76	21	1									554		
女性	10	30	41	32	11	11	10	2	0									147		
男女合計	45	116	148	144	65	73	86	23	1									701		

県 北

	20	割合	30	割合	40	割合	50	割合	64	割合	69	割合	70～	割合	全体数	割合
1と回答																
男性	1	12.5%	6	23.1%	4	14.3%	4	11.4%	0	0.0%	4	30.8%	9	31.0%	28	18.7%
女性	0	0.0%	4	66.7%	1	14.3%	1	14.3%	4	66.7%	1	100.0%	0	0.0%	11	36.7%
男女合計	1	12.5%	10	31.3%	5	14.3%	5	11.9%	4	23.5%	5	35.7%	9	28.1%	39	21.7%
2と回答																
男性	3	37.5%	13	50.0%	12	42.9%	16	45.7%	6	54.5%	7	53.8%	8	27.6%	65	43.3%
女性	0	0.0%	0	0.0%	1	14.3%	3	42.9%	0	0.0%	0	0.0%	1	33.3%	5	16.7%
男女合計	3	37.5%	13	40.6%	13	37.1%	19	45.2%	6	35.3%	7	50.0%	9	28.1%	70	38.9%
3と回答																
男性	2	25.0%	2	7.7%	7	25.0%	10	28.6%	2	18.2%	1	7.7%	9	31.0%	33	22.0%
女性	0	0.0%	2	33.3%	3	42.9%	1	14.3%	1	16.7%	0	0.0%	2	66.7%	9	30.0%
男女合計	2	25.0%	4	12.5%	10	28.6%	11	26.2%	3	17.6%	1	7.1%	11	34.4%	42	23.3%
4と回答																
男性	2	25.0%	4	15.4%	5	17.9%	4	11.4%	2	18.2%	0	0.0%	3	10.3%	20	13.3%
女性	0	0.0%	0	0.0%	2	28.6%	2	28.6%	1	16.7%	0	0.0%	0	0.0%	5	16.7%
男女合計	2	25.0%	4	12.5%	7	20.0%	6	14.3%	3	17.6%	0	0.0%	3	9.4%	25	13.9%
無回答																
男性	0	0.0%	1	3.8%	0	0.0%	1	2.9%	1	9.1%	1	7.7%	0	0.0%	4	2.7%
女性	0	0.0%	0	0.0%	0	0.0%	0	0.0%	0	0.0%	0	0.0%	0	0.0%	0	0.0%
男女合計	0	0.0%	1	3.1%	0	0.0%	1	2.4%	1	5.9%	1	7.1%	0	0.0%	4	2.2%
全体(人)																
男性	8		26		28		35		11		13		29		150	
女性	0		6		7		7		6		1		3		30	
男女合計	8		32		35		42		17		14		32		180	

県 中

	20	割合	30	割合	40	割合	50	割合	64	割合	69	割合	70～	割合	全体数	割合
1と回答																
男性	1	16.7%	6	28.6%	9	28.1%	7	26.9%	3	21.4%	1	7.7%	5	27.8%	32	24.6%
女性	1	20.0%	0	0.0%	4	40.0%	4	36.4%	0	0.0%	2	100.0%	1	100.0%	12	34.3%
男女合計	2	18.2%	6	23.1%	13	31.0%	11	29.7%	3	20.0%	3	20.0%	6	31.6%	44	26.7%
2と回答																
男性	2	33.3%	4	19.0%	5	15.6%	8	30.8%	5	35.7%	7	53.8%	8	44.4%	39	30.0%
女性	1	20.0%	2	40.0%	0	0.0%	2	18.2%	1	100.0%	0	0.0%	0	0.0%	6	17.1%
男女合計	3	27.3%	6	23.1%	5	11.9%	10	27.0%	6	40.0%	7	46.7%	8	42.1%	45	27.3%
3と回答																
男性	0	0.0%	4	19.0%	9	28.1%	4	15.4%	4	28.6%	5	38.5%	3	16.7%	29	22.3%
女性	2	40.0%	1	20.0%	4	40.0%	2	18.2%	0	0.0%	0	0.0%	0	0.0%	9	25.7%
男女合計	2	18.2%	5	19.2%	13	31.0%	6	16.2%	4	26.7%	5	33.3%	3	15.8%	38	23.0%
4と回答																
男性	3	50.0%	6	28.6%	8	25.0%	7	26.9%	1	7.1%	0	0.0%	2	11.1%	27	20.8%
女性	1	20.0%	1	20.0%	2	20.0%	3	27.3%	0	0.0%	0	0.0%	0	0.0%	7	20.0%
男女合計	4	36.4%	7	26.9%	10	23.8%	10	27.0%	1	6.7%	0	0.0%	2	10.5%	34	20.6%
無回答																
男性	0	0.0%	1	4.8%	1	3.1%	0	0.0%	1	7.1%	0	0.0%	0	0.0%	3	2.3%
女性	0	0.0%	1	20.0%	0	0.0%	0	0.0%	0	0.0%	0	0.0%	0	0.0%	1	2.9%
男女合計	0	0.0%	2	7.7%	1	2.4%	0	0.0%	1	6.7%	0	0.0%	0	0.0%	4	2.4%
全体(人)																
男性	6		21		32		26		14		13		18		130	
女性	5		5		10		11		1		2		1		35	
男女合計	11		26		42		37		15		15		19		165	

県 南

	20	割合	30	割合	40	割合	50	割合	64	割合	69	割合	70～	割合	全体数	割合
1と回答																
男性	1	20.0%	1	33.3%	2	33.3%	5	41.7%	0	0.0%	2	25.0%	2	28.6%	13	28.9%
女性	0	0.0%	2	66.7%	1	20.0%	0	0.0%	0	0.0%	0	0.0%	1	100.0%	4	28.6%
男女合計	1	20.0%	3	50.0%	3	27.3%	5	33.3%	0	0.0%	2	22.2%	3	37.5%	17	28.8%
2と回答																
男性	2	40.0%	1	33.3%	2	33.3%	3	25.0%	1	25.0%	5	62.5%	0	0.0%	14	31.1%
女性	0	0.0%	0	0.0%	3	60.0%	1	33.3%	0	0.0%	1	100.0%	0	0.0%	5	35.7%
男女合計	2	40.0%	1	16.7%	5	45.5%	4	26.7%	1	20.0%	6	66.7%	0	0.0%	19	32.2%
3と回答																
男性	0	0.0%	0	0.0%	1	16.7%	4	33.3%	2	50.0%	1	12.5%	4	57.1%	12	26.7%
女性	0	0.0%	0	0.0%	1	20.0%	0	0.0%	1	100.0%	0	0.0%	0	0.0%	2	14.3%
男女合計	0	0.0%	0	0.0%	2	18.2%	4	26.7%	3	60.0%	1	11.1%	4	50.0%	14	23.7%
4と回答																
男性	2	40.0%	1	33.3%	1	16.7%	0	0.0%	1	25.0%	0	0.0%	0	0.0%	5	11.1%
女性	0	0.0%	0	0.0%	0	0.0%	2	66.7%	0	0.0%	0	0.0%	0	0.0%	2	14.3%
男女合計	2	40.0%	1	16.7%	1	9.1%	2	13.3%	1	20.0%	0	0.0%	0	0.0%	7	11.9%
無回答																
男性	0	0.0%	0	0.0%	0	0.0%	0	0.0%	0	0.0%	0	0.0%	1	14.3%	1	2.2%
女性	0	0.0%	1	33.3%	0	0.0%	0	0.0%	0	0.0%	0	0.0%	0	0.0%	1	7.1%
男女合計	0	0.0%	1	16.7%	0	0.0%	0	0.0%	0	0.0%	0	0.0%	1	12.5%	2	3.4%
全体(人)																
男性	5		3		6		12		4		8		7		45	
女性	0		3		5		3		1		1		1		14	
男女合計	5		6		11		15		5		9		8		59	

会 津

	20	割合	30	割合	40	割合	50	割合	64	割合	69	割合	70～	割合	全体数	割合
1と回答																
男性	0	0.0%	2	33.3%	4	44.4%	2	14.3%	4	33.3%	2	28.6%	7	29.2%	21	28.0%
女性	0	0.0%	3	42.9%	1	20.0%	2	100.0%	0	0.0%	0	0.0%	3	100.0%	9	39.1%
男女合計	0	0.0%	5	38.5%	5	35.7%	4	25.0%	4	30.8%	2	20.0%	10	37.0%	30	30.6%
2と回答																
男性	2	66.7%	0	0.0%	1	11.1%	6	42.9%	7	58.3%	4	57.1%	9	37.5%	29	38.7%
女性	2	100.0%	1	14.3%	1	20.0%	0	0.0%	1	100.0%	2	66.7%	0	0.0%	7	30.4%
男女合計	4	80.0%	1	7.7%	2	14.3%	6	37.5%	8	61.5%	6	60.0%	9	33.3%	36	36.7%
3と回答																
男性	1	33.3%	1	16.7%	4	44.4%	5	35.7%	1	8.3%	1	14.3%	7	29.2%	20	26.7%
女性	0	0.0%	2	28.6%	1	20.0%	0	0.0%	0	0.0%	1	33.3%	0	0.0%	4	17.4%
男女合計	1	20.0%	3	23.1%	5	35.7%	5	31.3%	1	7.7%	2	20.0%	7	25.9%	24	24.5%
4と回答																
男性	0	0.0%	3	50.0%	0	0.0%	1	7.1%	0	0.0%	0	0.0%	1	4.2%	5	6.7%
女性	0	0.0%	1	14.3%	2	40.0%	0	0.0%	0	0.0%	0	0.0%	0	0.0%	3	13.0%
男女合計	0	0.0%	4	30.8%	2	14.3%	1	6.3%	0	0.0%	0	0.0%	1	3.7%	8	8.2%
無回答																
男性	0	0.0%	0	0.0%	0	0.0%	0	0.0%	0	0.0%	0	0.0%	0	0.0%	0	0.0%
女性	0	0.0%	0	0.0%	0	0.0%	0	0.0%	0	0.0%	0	0.0%	0	0.0%	0	0.0%
男女合計	0	0.0%	0	0.0%	0	0.0%	0	0.0%	0	0.0%	0	0.0%	0	0.0%	0	0.0%
全体(人)																
男性	3		6		9		14		12		7		24		75	
女性	2		7		5		2		1		3		3		23	
男女合計	5		13		14		16		13		10		27		98	

南 会 津

	20	割合	30	割合	40	割合	50	割合	64	割合	69	割合	70～	割合	全体数	割合
1と回答																
男性	0	0.0%	0	0.0%	0	0.0%	1	100.0%	0	0.0%	1	100.0%	1	100.0%	3	75.0%
女性	0	0.0%	0	0.0%	0	0.0%	1	100.0%	0	0.0%	0	0.0%	0	0.0%	1	50.0%
男女合計	0	0.0%	0	0.0%	0	0.0%	2	100.0%	0	0.0%	1	100.0%	1	100.0%	4	66.7%
2と回答																
男性	0	0.0%	1	100.0%	0	0.0%	0	0.0%	0	0.0%	0	0.0%	0	0.0%	1	25.0%
女性	0	0.0%	0	0.0%	0	0.0%	0	0.0%	0	0.0%	0	0.0%	0	0.0%	0	0.0%
男女合計	0	0.0%	1	100.0%	0	0.0%	0	0.0%	0	0.0%	0	0.0%	0	0.0%	1	16.7%
3と回答																
男性	0	0.0%	0	0.0%	0	0.0%	0	0.0%	0	0.0%	0	0.0%	0	0.0%	0	0.0%
女性	0	0.0%	0	0.0%	1	100.0%	0	0.0%	0	0.0%	0	0.0%	0	0.0%	1	50.0%
男女合計	0	0.0%	0	0.0%	1	100.0%	0	0.0%	0	0.0%	0	0.0%	0	0.0%	1	16.7%
4と回答																
男性	0	0.0%	0	0.0%	0	0.0%	0	0.0%	0	0.0%	0	0.0%	0	0.0%	0	0.0%
女性	0	0.0%	0	0.0%	0	0.0%	0	0.0%	0	0.0%	0	0.0%	0	0.0%	0	0.0%
男女合計	0	0.0%	0	0.0%	0	0.0%	0	0.0%	0	0.0%	0	0.0%	0	0.0%	0	0.0%
無回答																
男性	0	0.0%	0	0.0%	0	0.0%	0	0.0%	0	0.0%	0	0.0%	0	0.0%	0	0.0%
女性	0	0.0%	0	0.0%	0	0.0%	0	0.0%	0	0.0%	0	0.0%	0	0.0%	0	0.0%
男女合計	0	0.0%	0	0.0%	0	0.0%	0	0.0%	0	0.0%	0	0.0%	0	0.0%	0	0.0%
全体(人)																
男性	0		1		0		1		0		1		1		4	
女性	0		0		1		1		0		0		0		2	
男女合計	0		1		1		2		0		1		1		6	

相 双

	20	割合	30	割合	40	割合	50	割合	64	割合	69	割合	70～	割合	全体数	割合
1と回答																
男性	2	33.3%	1	25.0%	1	16.7%	1	16.7%	2	40.0%	1	16.7%	0	0.0%	8	23.5%
女性	1	100.0%	0	0.0%	0	0.0%	0	0.0%	0	0.0%	0	0.0%	0	0.0%	1	11.1%
男女合計	3	42.9%	1	16.7%	1	14.3%	1	14.3%	2	40.0%	1	14.3%	0	0.0%	9	20.9%
2と回答																
男性	1	16.7%	1	25.0%	2	33.3%	3	50.0%	1	20.0%	4	66.7%	1	100.0%	13	38.2%
女性	0	0.0%	1	50.0%	1	100.0%	1	100.0%	0	0.0%	1	100.0%	2	66.7%	6	66.7%
男女合計	1	14.3%	2	33.3%	3	42.9%	4	57.1%	1	20.0%	5	71.4%	3	75.0%	19	44.2%
3と回答																
男性	1	16.7%	1	25.0%	3	50.0%	1	16.7%	1	20.0%	0	0.0%	0	0.0%	7	20.6%
女性	0	0.0%	0	0.0%	0	0.0%	0	0.0%	0	0.0%	0	0.0%	1	33.3%	1	11.1%
男女合計	1	14.3%	1	16.7%	3	42.9%	1	14.3%	1	20.0%	0	0.0%	1	25.0%	8	18.6%
4と回答																
男性	2	33.3%	1	25.0%	0	0.0%	1	16.7%	1	20.0%	1	16.7%	0	0.0%	6	17.6%
女性	0	0.0%	1	50.0%	0	0.0%	0	0.0%	0	0.0%	0	0.0%	0	0.0%	1	11.1%
男女合計	2	28.6%	2	33.3%	0	0.0%	1	14.3%	1	20.0%	1	14.3%	0	0.0%	7	16.3%
無回答																
男性	0	0.0%	0	0.0%	0	0.0%	0	0.0%	0	0.0%	0	0.0%	0	0.0%	0	0.0%
女性	0	0.0%	0	0.0%	0	0.0%	0	0.0%	0	0.0%	0	0.0%	0	0.0%	0	0.0%
男女合計	0	0.0%	0	0.0%	0	0.0%	0	0.0%	0	0.0%	0	0.0%	0	0.0%	0	0.0%
全体(人)																
男性	6		4		6		6		5		6		1		34	
女性	1		2		1		1		0		1		3		9	
男女合計	7		6		7		7		5		7		4		43	

いわき

	20	割合	30	割合	40	割合	50	割合	64	割合	69	割合	70～	割合	全体数	割合
1と回答																
男性	1	14.3%	3	12.0%	6	23.1%	5	27.8%	1	12.5%	3	21.4%	5	27.8%	24	20.7%
女性	1	50.0%	3	42.9%	4	33.3%	0	0.0%	0	0.0%	1	33.3%	0	0.0%	9	26.5%
男女合計	2	22.2%	6	18.8%	10	26.3%	5	20.0%	1	10.0%	4	23.5%	5	26.3%	33	22.0%
2と回答																
男性	3	42.9%	9	36.0%	6	23.1%	7	38.9%	4	50.0%	8	57.1%	5	27.8%	42	36.2%
女性	0	0.0%	0	0.0%	3	25.0%	1	14.3%	0	0.0%	0	0.0%	1	100.0%	5	14.7%
男女合計	3	33.3%	9	28.1%	9	23.7%	8	32.0%	4	40.0%	8	47.1%	6	31.6%	47	31.3%
3と回答																
男性	2	28.6%	6	24.0%	8	30.8%	4	22.2%	1	12.5%	3	21.4%	4	22.2%	28	24.1%
女性	1	50.0%	0	0.0%	2	16.7%	3	42.9%	1	50.0%	1	33.3%	0	0.0%	8	23.5%
男女合計	3	33.3%	6	18.8%	10	26.3%	7	28.0%	2	20.0%	4	23.5%	4	21.1%	36	24.0%
4と回答																
男性	1	14.3%	7	28.0%	6	23.1%	2	11.1%	1	12.5%	0	0.0%	4	22.2%	21	18.1%
女性	0	0.0%	4	57.1%	3	25.0%	2	28.6%	1	50.0%	1	33.3%	0	0.0%	11	32.4%
男女合計	1	11.1%	11	34.4%	9	23.7%	4	16.0%	2	20.0%	1	5.9%	4	21.1%	32	21.3%
無回答																
男性	0	0.0%	0	0.0%	0	0.0%	0	0.0%	1	12.5%	0	0.0%	0	0.0%	1	0.9%
女性	0	0.0%	0	0.0%	0	0.0%	1	14.3%	0	0.0%	0	0.0%	0	0.0%	1	2.9%
男女合計	0	0.0%	0	0.0%	0	0.0%	1	4.0%	1	10.0%	0	0.0%	0	0.0%	2	1.3%
全体(人)																
男性	7		25		26		18		8		14		18		116	
女性	2		7		12		7		2		3		1		34	
男女合計	9		32		38		25		10		17		19		150	

(3) 家族(世帯)の喫煙状況(調査票 問12)

問12 あなたの家族で、あなたを含めて、たばこを吸っている方はいますか。

1 いる 2 いない



	県北	割合	県中	割合	県南	割合	会津	割合	南会津	割合	相双	割合	いわき	割合	全体数	割合
1 いる	185	33.2%	165	35.6%	66	33.8%	112	33.9%	10	30.3%	46	34.3%	158	40.2%	742	35.2%
2 いない	365	65.5%	286	61.8%	126	64.6%	209	63.3%	22	66.7%	86	64.2%	225	57.3%	1,319	62.7%
不明	7	1.3%	12	2.6%	3	1.5%	9	2.7%	1	3.0%	2	1.5%	10	2.5%	44	2.1%
回答世帯数	557		463		195		330		33		134		393		2,105	

13 受動喫煙の有無（満15歳以上対象）（調査票 問13）

問13 あなたは、この1か月間に、自分以外の人が吸っていたたばこの煙を吸う機会（受動喫煙）がありましたか。（各項目につき、○は1つ）

- 1 ほぼ毎日 2 週に数回程度 3 週に1回程度
4 月に1回程度 5 全くなかった 6 いかなかった

○家 庭

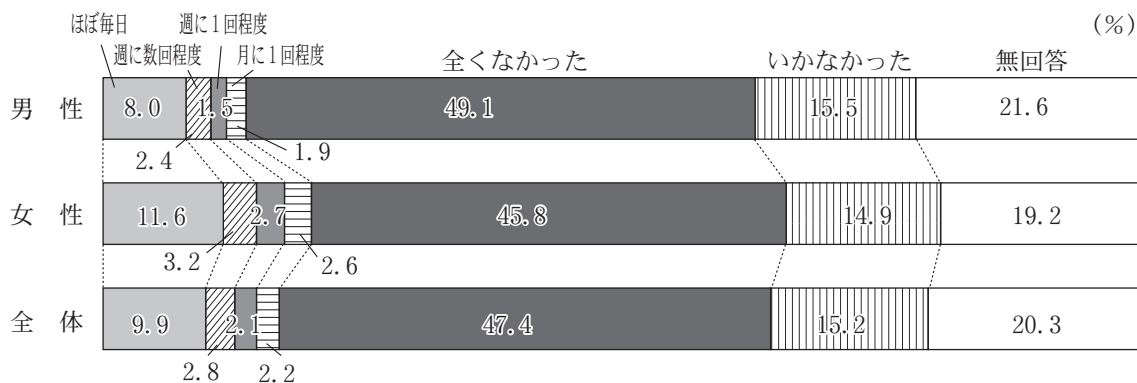

○職 場

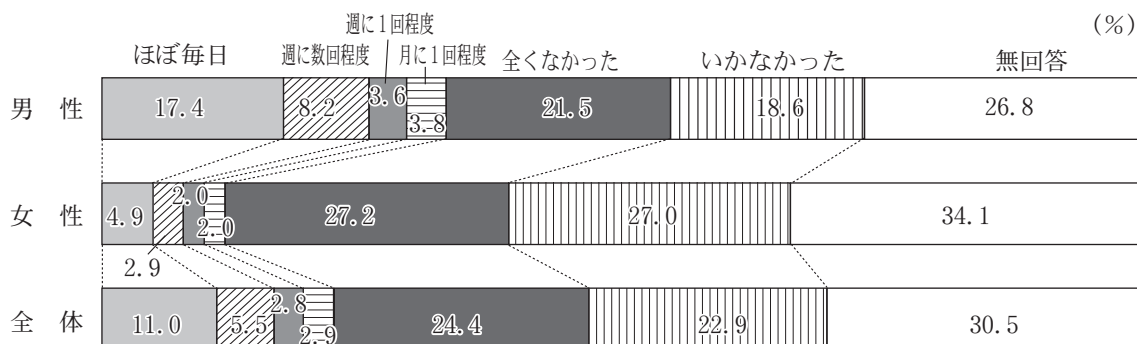

○学 校

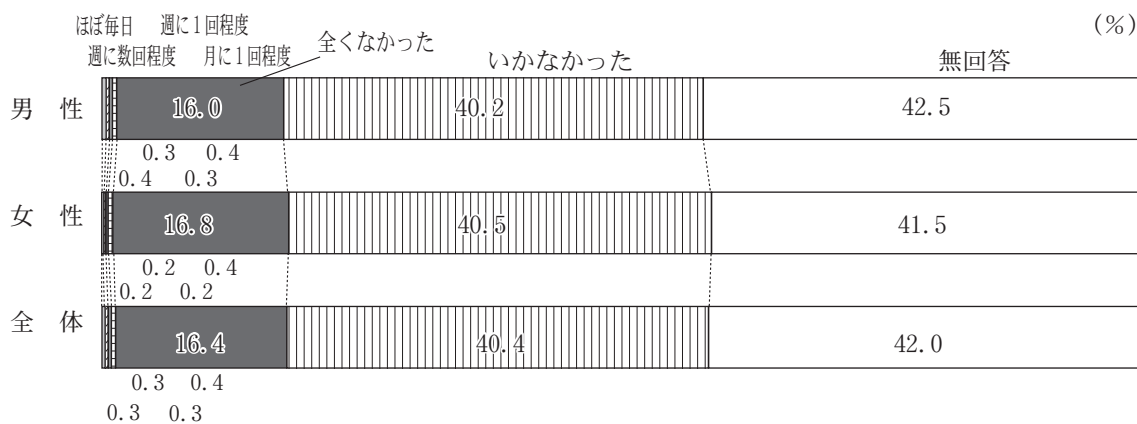

○飲食店

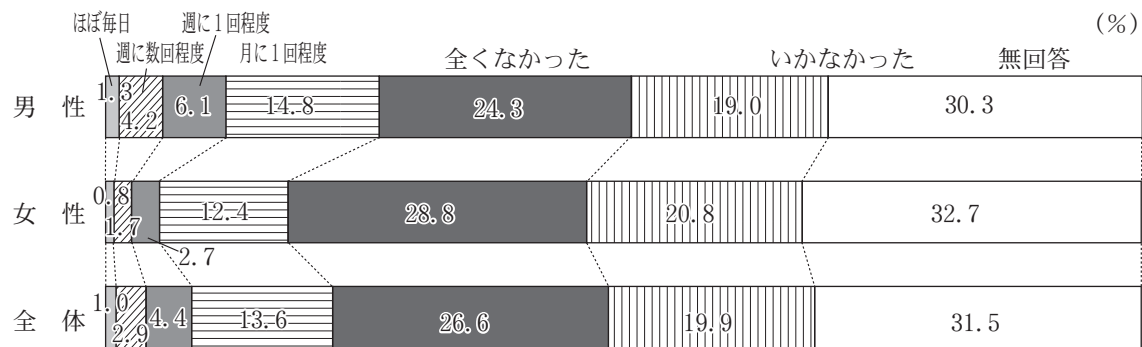

○遊技場



○行政機関

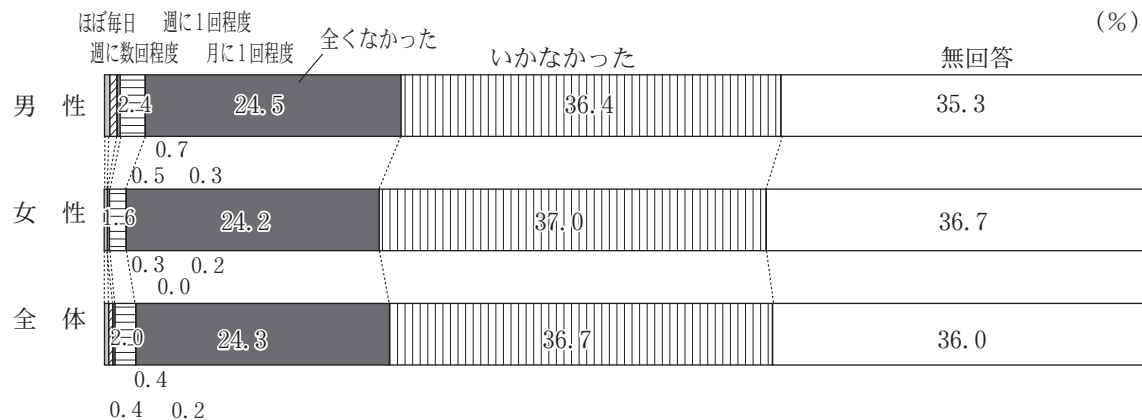

○医療機関

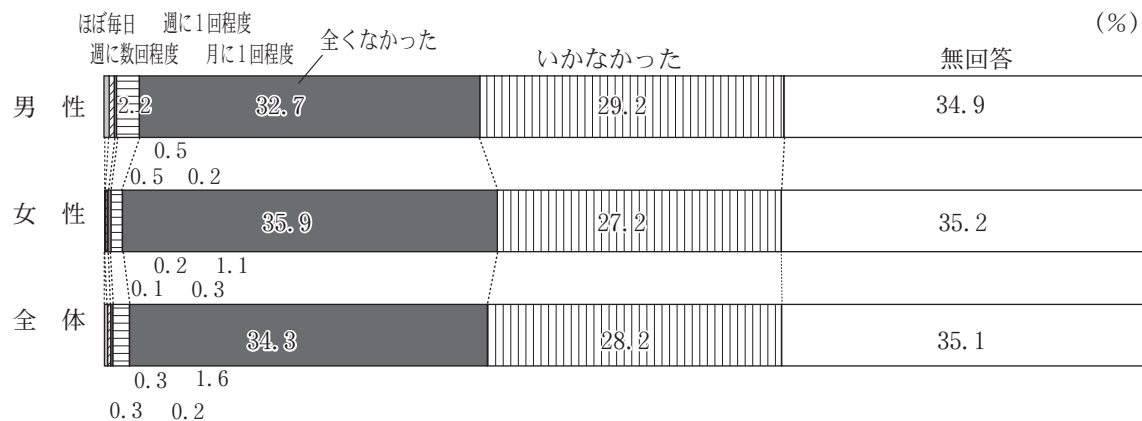

○公共交通機関

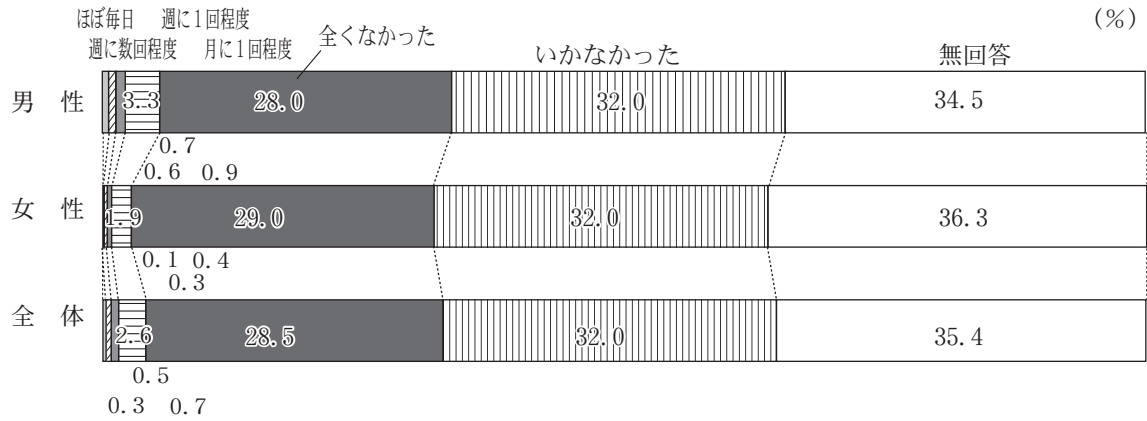

○路上

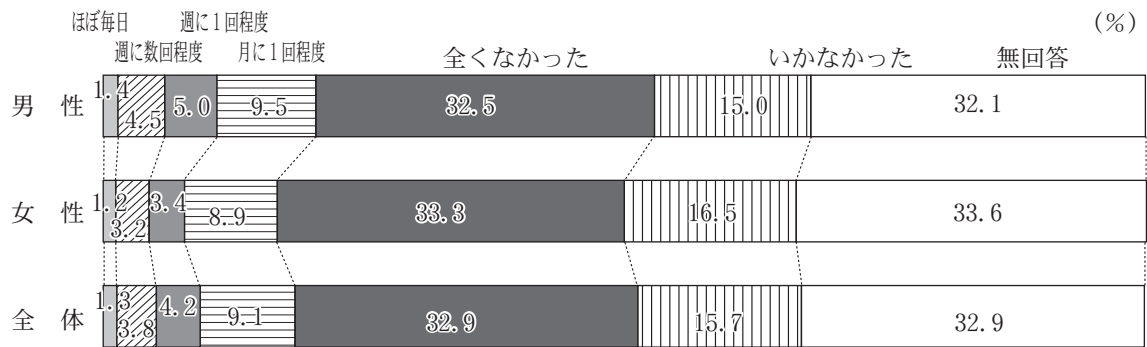

○子供が利用する屋外の空間

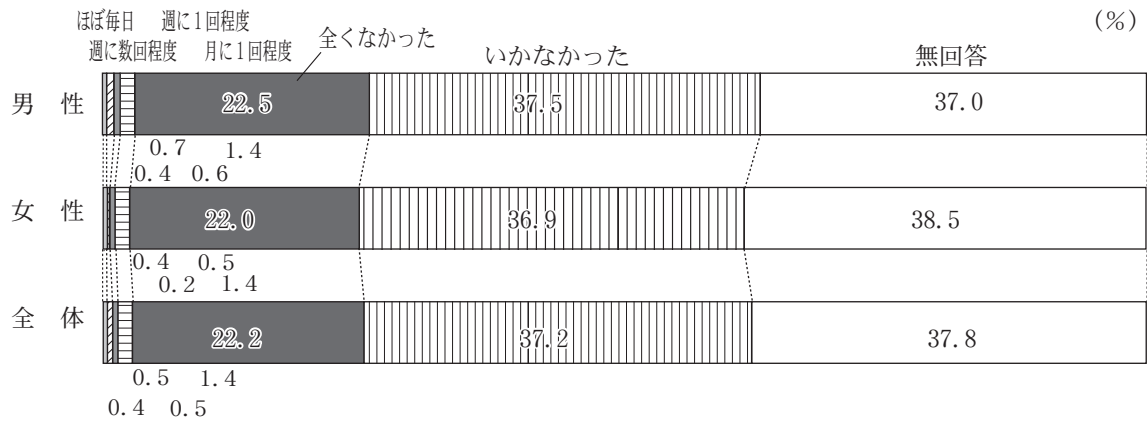

○健康増進施設

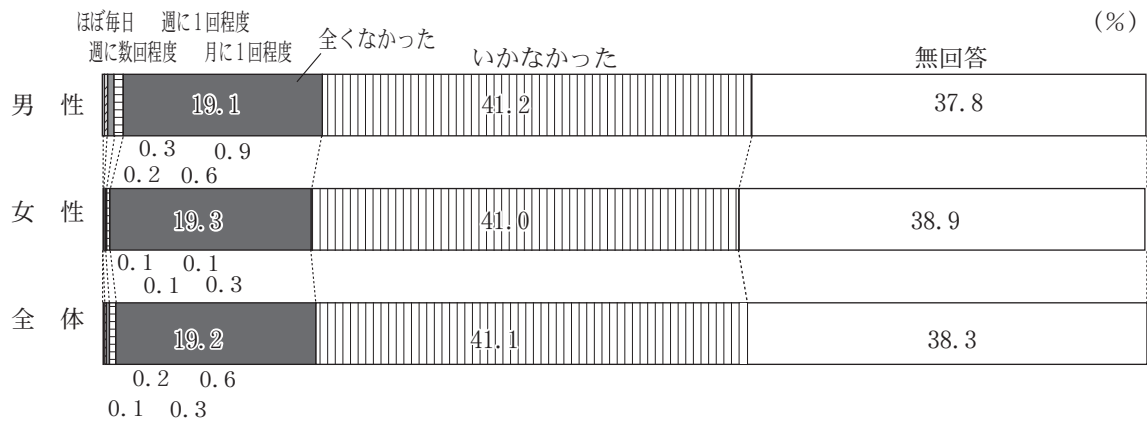

○家庭

	10	割合	20	割合	30	割合	40	割合	50	割合	64	割合	69	割合	70	割合	80	割合	90	割合	全体数	割合
1 上回答	11	14.5%	15	12.5%	27	13.1%	21	8.3%	30	11.0%	21	10.7%	10	4.1%	17	4.3%	8	3.9%	0	0.0%	160	8.0%
男性	8	11.8%	16	13.1%	28	16.2%	44	17.2%	52	15.7%	21	10.3%	26	10.2%	30	8.2%	14	5.6%	3	5.7%	242	11.6%
女性	3	2.9%	6	4.9%	12	6.9%	10	3.9%	10	3.0%	3	1.5%	8	3.1%	8	2.2%	7	2.8%	0	0.0%	18	0.9%
男女合計	19	13.2%	31	12.8%	55	14.5%	65	12.8%	82	13.6%	42	10.5%	36	7.2%	47	6.1%	22	4.9%	3	4.2%	402	9.9%
2 上回答	4	5.3%	4	3.3%	7	3.4%	6	2.4%	5	1.8%	2	1.0%	9	3.7%	7	1.8%	4	2.0%	0	0.0%	48	2.4%
男性	2	2.9%	6	4.9%	12	6.9%	10	3.9%	10	3.0%	3	1.5%	8	3.1%	8	2.2%	7	2.8%	0	0.0%	66	3.2%
女性	2	2.9%	4	3.3%	7	3.4%	6	2.4%	5	1.8%	2	1.0%	9	3.7%	7	1.8%	4	2.0%	0	0.0%	18	0.9%
男女合計	6	4.2%	10	4.1%	19	5.0%	16	3.1%	15	2.5%	5	1.3%	17	3.4%	15	2.0%	11	2.4%	0	0.0%	114	2.8%
3 上回答	1	1.3%	3	2.5%	3	1.5%	3	1.2%	3	1.1%	0	0.0%	1	0.4%	11	2.8%	4	2.0%	0	0.0%	29	1.5%
男性	2	2.9%	7	5.7%	9	5.2%	9	3.5%	9	2.7%	5	2.5%	4	1.6%	9	2.4%	2	0.8%	0	0.0%	56	2.7%
女性	3	2.1%	10	4.1%	12	3.2%	12	2.4%	12	2.0%	5	1.3%	5	1.0%	20	2.6%	6	1.3%	0	0.0%	85	2.1%
男女合計	3	2.1%	10	4.1%	12	3.2%	12	2.4%	12	2.0%	5	1.3%	5	1.0%	20	2.6%	6	1.3%	0	0.0%	85	2.1%
4 上回答	3	3.9%	4	3.3%	3	1.5%	6	2.4%	3	1.1%	4	2.0%	1	0.4%	9	2.3%	4	2.0%	0	0.0%	37	1.9%
男性	4	5.9%	6	4.9%	5	2.9%	8	3.1%	8	2.4%	3	1.5%	7	2.7%	7	1.9%	5	2.0%	1	1.9%	54	2.6%
女性	7	4.9%	10	4.1%	8	2.1%	14	2.8%	11	1.6%	7	1.8%	8	1.6%	16	2.1%	9	2.0%	1	1.4%	91	2.2%
男女合計	7	4.9%	10	4.1%	8	2.1%	14	2.8%	11	1.6%	7	1.8%	8	1.6%	16	2.1%	9	2.0%	1	1.4%	91	2.2%
5 上回答	39	51.3%	55	45.8%	101	49.0%	133	52.6%	137	50.4%	98	49.7%	132	53.9%	176	44.2%	98	48.3%	8	44.4%	977	49.1%
男性	34	50.0%	52	42.6%	84	48.6%	109	42.6%	175	52.9%	112	55.2%	123	48.2%	152	41.3%	85	34.1%	26	49.1%	952	45.8%
女性	5	6.3%	3	2.2%	17	7.4%	24	9.0%	62	22.2%	86	41.5%	109	41.0%	24	6.1%	13	5.1%	1	5.0%	25	1.2%
男女合計	73	50.7%	107	44.2%	185	48.8%	242	47.5%	312	51.7%	210	52.5%	255	51.0%	328	42.8%	183	40.5%	34	47.9%	1929	47.4%
6 上回答	11	14.5%	27	22.5%	43	20.9%	49	19.4%	52	19.1%	25	12.7%	36	14.7%	45	11.3%	18	8.9%	2	11.1%	308	15.5%
男性	12	17.6%	22	18.0%	22	12.7%	42	16.4%	49	14.8%	31	15.3%	39	15.3%	42	11.4%	45	18.1%	6	11.3%	310	14.9%
女性	23	16.0%	49	20.2%	65	17.2%	91	17.9%	101	16.7%	56	14.0%	75	15.0%	87	11.4%	63	13.9%	8	11.3%	618	15.2%
男女合計	23	16.0%	49	20.2%	65	17.2%	91	17.9%	101	16.7%	56	14.0%	75	15.0%	87	11.4%	63	13.9%	8	11.3%	618	15.2%
無回答	7	9.2%	12	10.0%	22	10.7%	35	13.8%	42	15.4%	47	23.9%	56	22.9%	133	33.4%	67	33.0%	8	44.4%	429	21.6%
男性	6	8.8%	13	10.7%	13	7.5%	34	13.3%	28	8.5%	28	13.8%	48	18.8%	120	32.6%	91	36.5%	17	32.1%	398	19.2%
女性	13	9.0%	25	10.3%	35	9.2%	69	13.6%	70	11.6%	75	18.8%	104	20.8%	158	33.0%	25	35.2%	25	35.2%	827	20.3%
男女合計	13	9.0%	25	10.3%	35	9.2%	69	13.6%	70	11.6%	75	18.8%	104	20.8%	158	33.0%	25	35.2%	25	35.2%	827	20.3%
全体(人)	76		120		206		253		272		197		245		398		203		18		1988	
男性	68		122		173		256		331		203		255		368		249		53		2078	
女性	144		242		379		509		603		400		500		766		452		71		4066	

○職場

	10	割合	20	割合	30	割合	40	割合	50	割合	64	割合	69	割合	70	割合	80	割合	90	割合	全体数	割合
1 上回答	3	3.9%	34	28.3%	76	36.9%	70	27.7%	76	27.9%	40	20.3%	30	12.2%	16	4.0%	1	0.5%	0	0.0%	346	17.4%
男性	1	1.5%	12	9.8%	17	9.8%	28	10.9%	23	6.9%	13	6.4%	3	1.2%	1	0.3%	3	1.2%	0	0.0%	101	4.9%
女性	4	2.8%	46	19.0%	93	24.5%	98	19.3%	99	16.4%	53	13.3%	33	6.6%	17	2.2%	4	0.9%	0	0.0%	447	11.0%
男女合計	1	1.3%	7	5.8%	33	16.0%	40	15.8%	44	16.2%	18	9.1%	11	4.5%	9	2.3%	1	0.5%	0	0.0%	164	8.2%
男性	3	4.4%	6	4.9%	9	5.2%	16	6.3%	15	4.5%	4	2.0%	4	1.6%	4	1.1%	0	0.0%	0	0.0%	61	2.9%
女性	4	2.8%	13	5.4%	42	11.1%	56	11.0%	59	9.8%	22	5.5%	15	3.0%	13	1.7%	1	0.2%	0	0.0%	225	5.5%
男女合計	2	1.3%	7	5.8%	10	4.9%	16	6.3%	13	4.8%	10	5.1%	8	3.3%	5	1.3%	2	1.0%	0	0.0%	72	3.6%
男性	1	1.3%	4	3.3%	5	2.9%	7	2.7%	12	3.6%	3	1.5%	1	0.4%	7	1.9%	0	0.0%	0	0.0%	41	2.0%
女性	3	2.1%	11	4.5%	15	4.0%	23	4.5%	25	4.1%	13	3.3%	9	1.8%	12	1.6%	2	0.4%	0	0.0%	113	2.8%
男女合計	0	0.0%	7	5.8%	14	6.8%	17	6.7%	17	6.3%	6	3.0%	5	2.0%	7	1.8%	2	1.0%	0	0.0%	75	3.8%
男性	0	0.0%	7	5.7%	8	4.6%	13	5.1%	6	1.8%	2	1.0%	2	0.8%	3	0.8%	0	0.0%	0	0.0%	41	2.0%
女性	0	0.0%	14	5.8%	22	5.8%	30	5.9%	23	3.8%	8	2.0%	7	1.4%	10	1.3%	2	0.4%	0	0.0%	116	2.9%
男女合計	18	23.7%	25	20.8%	45	21.8%	58	22.9%	62	22.8%	56	28.4%	55	22.4%	64	16.1%	44	21.7%	1	5.6%	428	21.5%
男性	16	23.5%	43	35.2%	67	38.7%	97	37.9%	134	40.5%	56	27.6%	64	25.1%	59	16.0%	25	10.0%	4	7.5%	565	27.2%
女性	34	23.6%	68	28.1%	112	29.6%	155	30.5%	196	32.5%	112	28.0%	119	23.8%	123	16.1%	69	15.3%	5	7.0%	993	24.4%
男女合計	39	51.3%	27	22.5%	13	6.3%	23	9.1%	28	10.3%	30	15.2%	65	26.5%	102	25.6%	38	18.7%	5	27.8%	370	18.6%
男性	31	45.6%	29	23.8%	50	28.9%	60	23.4%	86	26.0%	70	34.5%	64	25.1%	86	23.4%	64	25.7%	21	39.6%	561	27.0%
女性	70	48.6%	56	23.1%	63	16.6%	83	16.3%	114	18.9%	100	25.0%	129	25.8%	188	24.5%	102	22.6%	26	36.6%	931	22.9%
男女合計	14	18.4%	13	10.8%	15	7.3%	29	11.5%	32	11.8%	37	18.8%	71	29.0%	195	49.0%	115	56.7%	12	66.7%	533	26.8%
男性	15	22.1%	21	17.2%	17	9.8%	35	13.7%	55	16.6%	55	27.1%	117	45.9%	208	56.5%	157	63.1%	28	52.8%	708	34.1%
女性	29	20.1%	34	14.0%	32	8.4%	64	12.6%	87	14.4%	92	23.0%	188	37.6%	403	52.6%	272	60.2%	40	56.3%	1241	30.5%
男女合計	76		120		206		253		272		197		245		398		203		18		1988	
男性	68		122		173		256		331		203		255		368		249		53		2078	
女性	144		242		379		509		603		400		500		766		452		71		4066	

○学校

	10	割合	20	割合	30	割合	40	割合	50	割合	64	割合	69	割合	70	割合	80	割合	90	割合	全体数	割合
1 上回答	1	1.3%	1	0.8%	1	0.5%	1	0.4%	2	0.7%	1	0.5%	0	0.0%	0	0.0%	0	0.0%	0	0.0%	7	0.4%
男性	0	0.0%	1	0.8%	0	0.0%	1	0.4%	1	0.3%	0	0.0%	0	0.0%	0	0.0%	2	0.8%	0	0.0%	5	0.2%
女性	1	0.7%	2	0.8%	1	0.3%	2	0.4%	3	0.5%	1	0.3%	0	0.0%	0	0.0%	2	0.4%	0	0.0%	12	0.3%
男女合計	1	1.3%	3	2.5%	0	0.0%	0	0.0%	0	0.0%	0	0.0%	1	0.4%	1	0.3%	0	0.0%	0	0.0%	6	0.3%
男性	3	4.4%	2	1.6%	0	0.0%	0	0.0%	0	0.0%	0	0.0%	0	0.0%	0	0.0%	0	0.0%	0	0.0%	5	0.2%
女性	4	2.8%	5	2.1%	0	0.0%	0	0.0%	0	0.0%	0	0.0%	1	0.2%	1	0.1%	0	0.0%	0	0.0%	11	0.3%
男女合計	1	1.3%	1	0.8%	2	1.0%	0	0.0%	0	0.0%	0	0.0%										

○飲食店

	10	割合	20	割合	30	割合	40	割合	50	割合	64	割合	69	割合	70	割合	80	割合	90	割合	全体数	割合
1と回答	0	0.0%	1	0.8%	4	1.9%	4	1.6%	5	1.8%	4	2.0%	3	1.2%	3	0.8%	1	0.5%	0	0.0%	25	1.3%
男性	0	0.0%	0	0.0%	2	1.2%	2	0.8%	6	1.8%	2	1.0%	0	0.0%	3	0.8%	2	0.8%	0	0.0%	17	0.8%
女性	0	0.0%	1	0.4%	6	1.6%	6	1.2%	11	1.8%	6	1.5%	3	0.6%	6	0.8%	3	0.7%	0	0.0%	42	1.0%
男女合計	0	0.0%	1	0.4%	6	1.6%	6	1.2%	11	1.8%	6	1.5%	3	0.6%	6	0.8%	3	0.7%	0	0.0%	42	1.0%
2と回答	2	2.6%	15	12.5%	11	5.3%	16	6.3%	10	3.7%	6	3.0%	9	3.7%	12	3.0%	2	1.0%	0	0.0%	83	4.2%
男性	4	5.9%	5	4.1%	4	2.3%	6	2.3%	6	1.8%	2	1.0%	4	1.6%	5	1.4%	0	0.0%	0	0.0%	36	1.7%
女性	2	2.6%	15	12.5%	11	5.3%	16	6.3%	10	3.7%	6	3.0%	9	3.7%	12	3.0%	2	1.0%	0	0.0%	83	4.2%
男女合計	6	4.2%	20	8.3%	15	4.0%	22	4.3%	16	2.7%	8	2.0%	13	2.6%	17	2.2%	2	0.4%	0	0.0%	119	2.9%
3と回答	1	1.3%	6	5.0%	15	7.3%	27	10.7%	38	14.0%	11	5.6%	9	3.7%	13	3.3%	2	1.0%	0	0.0%	122	6.1%
男性	0	0.0%	9	7.4%	8	4.6%	15	5.9%	13	3.9%	5	2.5%	2	0.8%	5	1.4%	0	0.0%	0	0.0%	57	2.7%
女性	1	0.7%	15	6.2%	23	6.1%	42	8.3%	51	8.5%	16	4.0%	11	2.2%	18	2.3%	2	0.4%	0	0.0%	179	4.4%
男女合計	1	0.7%	15	6.2%	23	6.1%	42	8.3%	51	8.5%	16	4.0%	11	2.2%	18	2.3%	2	0.4%	0	0.0%	179	4.4%
4と回答	10	13.2%	18	15.0%	50	24.3%	55	21.7%	51	18.8%	38	19.3%	33	13.5%	32	8.0%	6	3.0%	2	11.1%	295	14.8%
男性	13	19.1%	30	24.6%	49	28.3%	49	19.1%	57	17.2%	21	10.3%	24	9.4%	13	3.5%	0	0.0%	1	1.9%	257	12.4%
女性	23	16.0%	48	19.8%	99	26.1%	104	20.4%	108	17.9%	59	14.8%	57	11.4%	45	5.9%	6	1.3%	3	4.2%	552	13.6%
男女合計	23	16.0%	48	19.8%	99	26.1%	104	20.4%	108	17.9%	59	14.8%	57	11.4%	45	5.9%	6	1.3%	3	4.2%	552	13.6%
5と回答	28	36.8%	34	28.3%	51	24.8%	60	23.7%	55	20.2%	56	28.4%	60	24.5%	80	20.1%	57	28.1%	2	11.1%	483	24.3%
男性	30	44.1%	40	32.8%	56	32.4%	79	30.9%	116	35.0%	60	29.6%	77	30.2%	92	25.0%	41	16.5%	8	15.1%	599	28.8%
女性	58	40.3%	74	30.6%	107	28.2%	139	27.3%	171	28.4%	116	29.0%	137	27.4%	172	22.5%	98	21.7%	10	14.1%	1082	26.6%
男女合計	58	40.3%	74	30.6%	107	28.2%	139	27.3%	171	28.4%	116	29.0%	137	27.4%	172	22.5%	98	21.7%	10	14.1%	1082	26.6%
6と回答	25	32.9%	22	18.3%	41	19.9%	43	17.0%	48	17.6%	26	13.2%	57	23.3%	80	20.1%	33	16.3%	3	16.7%	378	19.0%
男性	15	22.1%	17	13.9%	37	21.4%	60	23.4%	74	22.4%	54	26.6%	45	17.6%	61	16.6%	51	20.5%	19	35.8%	433	20.8%
女性	40	27.8%	39	16.1%	78	20.6%	103	20.2%	122	20.2%	80	20.0%	102	20.4%	141	18.4%	84	18.6%	22	31.0%	811	19.9%
男女合計	40	27.8%	39	16.1%	78	20.6%	103	20.2%	122	20.2%	80	20.0%	102	20.4%	141	18.4%	84	18.6%	22	31.0%	811	19.9%
無回答	10	13.2%	24	20.0%	34	16.5%	48	19.0%	65	23.9%	56	28.4%	74	30.2%	178	44.7%	102	50.2%	11	61.1%	602	30.3%
男性	6	8.8%	21	17.2%	17	9.8%	45	17.6%	59	17.8%	59	29.1%	103	40.4%	189	51.4%	155	62.2%	25	47.2%	679	32.7%
女性	16	11.1%	45	18.6%	51	13.5%	93	18.3%	124	20.6%	115	28.8%	177	35.4%	367	47.9%	257	56.9%	36	50.7%	1281	31.5%
男女合計	16	11.1%	45	18.6%	51	13.5%	93	18.3%	124	20.6%	115	28.8%	177	35.4%	367	47.9%	257	56.9%	36	50.7%	1281	31.5%
全体(人)	76		120		206		253		272		197		245		398		203		18		1988	
男性	68		122		173		256		331		203		255		368		249		53		2078	
女性	144		242		379		509		603		400		500		766		452		71		4066	
男女合計	144		242		379		509		603		400		500		766		452		71		4066	

○遊技場

	10	割合	20	割合	30	割合	40	割合	50	割合	64	割合	69	割合	70	割合	80	割合	90	割合	全体数	割合		
1と回答	0	0.0%	1	0.8%	5	2.4%	8	3.2%	8	2.9%	2	1.0%	1	0.4%	6	1.5%	0	0.0%	0	0.0%	0	0.0%	31	1.6%
男性	0	0.0%	0	0.0%	0	0.0%	3	1.2%	2	0.6%	0	0.0%	1	0.4%	1	0.3%	2	0.8%	0	0.0%	0	0.0%	9	0.4%
女性	0	0.0%	1	0.4%	5	1.3%	11	2.2%	10	1.7%	2	0.5%	2	0.4%	7	0.9%	2	0.4%	0	0.0%	0	0.0%	40	1.0%
男女合計	0	0.0%	1	0.4%	5	1.3%	11	2.2%	10	1.7%	2	0.5%	2	0.4%	7	0.9%	2	0.4%	0	0.0%	0	0.0%	40	1.0%
2と回答	0	0.0%	7	5.8%	8	3.9%	9	3.6%	10	3.7%	15	7.6%	14	5.7%	12	3.0%	3	1.5%	0	0.0%	78	3.9%		
男性	0	0.0%	2	1.6%	3	1.7%	3	1.2%	4	1.2%	1	0.5%	2	0.8%	2	0.5%	1	0.4%	0	0.0%	18	0.9%		
女性	0	0.0%	9	3.7%	11	2.9%	12	2.4%	14	2.3%	16	4.0%	16	3.2%	14	1.8%	4	0.9%	0	0.0%	96	2.4%		
男女合計	0	0.0%	9	3.7%	11	2.9%	12	2.4%	14	2.3%	16	4.0%	16	3.2%	14	1.8%	4	0.9%	0	0.0%	96	2.4%		
3と回答	2	2.6%	5	4.2%	13	6.3%	16	6.3%	15	5.5%	16	8.1%	12	4.9%	13	3.3%	2	1.0%	0	0.0%	94	4.7%		
男性	1	1.5%	5	4.1%	2	1.2%	10	3.9%	1	0.3%	4	2.0%	3	1.2%	2	0.5%	0	0.0%	0	0.0%	28	1.3%		
女性	3	2.1%	10	4.1%	15	4.0%	26	5.1%	16	2.7%	20	5.0%	15	3.0%	15	2.0%	2	0.4%	0	0.0%	122	3.0%		
男女合計	3	2.1%	10	4.1%	15	4.0%	26	5.1%	16	2.7%	20	5.0%	15	3.0%	15	2.0%	2	0.4%	0	0.0%	122	3.0%		
4と回答	4	5.3%	9	7.5%	21	10.2%	17	6.7%	17	6.3%	7	3.6%	12	4.9%	12	3.0%	3	1.5%	0	0.0%	102	5.1%		
男性	3	4.4%	7	5.7%	12	6.9%	9	3.5%	6	1.8%	4	2.0%	6	2.4%	5	1.4%	0	0.0%	0	0.0%	52	2.5%		
女性	7	4.9%	16	6.6%	33	8.7%	26	5.1%	23	3.8%	11	2.8%	18	3.6%	17	2.2%	3	0.7%	0	0.0%	154	3.8%		
男女合計	7	4.9%	16	6.6%	33	8.7%	26	5.1%	23	3.8%	11	2.8%	18	3.6%	17	2.2%	3	0.7%	0	0.0%	154	3.8%		
5と回答	18	23.7%	21	17.5%	30	14.6%	31	12.3%	26	9.6%	21	10.7%	25	10.2%	47	11.8%	33	16.3%	1	5.6%	253	12.7%		
男性	20	29.4%	21	17.2%	35	20.2%	32	12.5%	51	15.4%	25	12.3%	43	16.9%	40	10.9%	23	9.2%	4	7.5%	294	14.1%		
女性	38	26.4%	42	17.4%	65	17.2%	63	12.4%	77	12.8%	46	11.5%	68	13.6%	87	11.4%	56	12.4%	5	7.0%	547	13.5%		
男女合計	38	26.4%	42	17.4%	65	17.2%	63	12.4%	77	12.8%	46	11.5%	68	13.6%	87	11.4%	56	12.4%	5	7.0%	547	13.5%		
6と回答	41	53.9%	55	45.8%	92	44.7%	118	46.6%	125	46.0%	66	33.5%	92	37.6%	122	30.7%	48	23.6%	5	27.8%	764	38.4%		
男性	34	50.0%	64	52.5%	98	56.6%	148	57.8%	187	56.5%	99	48.8%	82	32.2%	105	28.5%	65	26.1%	21	39.6%	903	43.5%		
女性	75	52.1%	119	49.2%	190	50.1%	266	52.3%	312	51.7%	165	41.3%	174	34.8%	227	29.6%	113	25.0%	26	36.6%	1667	41.0%		
男女合計	75	52.1%	119	49.2%	190	50.1%	266	52.3%	312	51.7%	165	41.3%	174	34.8%	227	29.6%	113	25.0%	26	36.6%	1667	41.0%		
無回答	11	14.5%	22	18.3%	37	18.0%	54	21.3%	71	26.1%	70	35.5%	89	36.3%	186	46.7%	114	56.2%	12	66.7%	666	33.5%		
男性	10	14.7%	23	18.9%	23	13.3%	51	19.9%	80	24.2%	70	34.5%	118	46.3%	213	57.9%	158	63.5%	28	52.8%	774	37.2%		
女性	21	14.6%	45	18.6%	60	15.8%	105	20.6%	151	25.0%	140	35.0%	207	41.4%	399	52.1%	272	60.2%	40	56.3%	1440	35.4%		
男女合計	21	14.6%	45	18.6%	60	15.8%	105	20.6%	151	25.0%	140	35.0%	207	41.4%	399	52.1%	272	60.2%	40	56.3%	1440	35.4%		
全体(人)	76		120		206		253		272		197		245		398		203		18		1988			
男性	68		122		173		256		331		203		255		368		249							

○医療機関

	10	割合	20	割合	30	割合	40	割合	50	割合	64	割合	69	割合	70	割合	80	割合	90	割合	全体数	割合		
1 上回答																								
男性	0	0.0%	0	0.0%	2	1.0%	2	0.8%	1	0.4%	3	1.5%	1	0.4%	0	0.0%	0	0.0%	0	0.0%	9	0.5%		
女性	0	0.0%	1	0.8%	0	0.0%	0	0.0%	0	0.0%	0	0.0%	0	0.0%	0	0.0%	0	0.0%	2	0.8%	0	0.0%	3	0.1%
男女合計	0	0.0%	1	0.4%	2	0.5%	2	0.4%	1	0.2%	3	0.8%	1	0.2%	0	0.0%	2	0.4%	0	0.0%	12	0.3%		
2 上回答																								
男性	0	0.0%	1	0.8%	0	0.0%	0	0.0%	1	0.4%	2	1.0%	2	0.8%	2	0.5%	1	0.5%	0	0.0%	9	0.5%		
女性	0	0.0%	0	0.0%	0	0.0%	1	0.4%	0	0.0%	0	0.0%	3	1.2%	0	0.0%	0	0.0%	0	0.0%	4	0.2%		
男女合計	0	0.0%	1	0.4%	0	0.0%	1	0.2%	1	0.2%	2	0.5%	5	1.0%	2	0.3%	1	0.2%	0	0.0%	13	0.3%		
3 上回答																								
男性	0	0.0%	1	0.8%	0	0.0%	0	0.0%	0	0.0%	0	0.0%	1	0.4%	1	0.3%	0	0.0%	0	0.0%	3	0.2%		
女性	0	0.0%	0	0.0%	1	0.6%	1	0.4%	1	0.3%	0	0.0%	1	0.4%	2	0.5%	0	0.0%	0	0.0%	6	0.3%		
男女合計	0	0.0%	1	0.4%	1	0.3%	1	0.2%	1	0.2%	0	0.0%	2	0.4%	3	0.4%	0	0.0%	0	0.0%	9	0.2%		
4 上回答																								
男性	1	1.3%	4	3.3%	4	1.9%	4	1.6%	3	1.1%	2	1.0%	10	4.1%	7	1.8%	6	3.0%	2	11.1%	43	2.2%		
女性	0	0.0%	2	1.6%	1	0.6%	3	1.2%	3	0.9%	2	1.0%	5	2.0%	3	0.8%	3	1.2%	0	0.0%	22	1.1%		
男女合計	1	0.7%	6	2.5%	5	1.3%	7	1.4%	6	1.0%	4	1.0%	15	3.0%	10	1.3%	9	2.0%	2	2.8%	65	1.6%		
5 上回答																								
男性	20	26.3%	32	26.7%	61	29.6%	90	35.6%	94	34.6%	74	37.6%	85	34.7%	126	31.7%	66	32.5%	2	11.1%	650	32.7%		
女性	22	32.4%	49	40.2%	79	45.7%	106	41.4%	142	42.9%	87	42.9%	86	33.7%	103	28.0%	57	22.9%	15	28.3%	746	35.9%		
男女合計	42	29.2%	81	33.5%	140	36.9%	196	38.5%	236	39.1%	161	40.3%	171	34.2%	229	29.9%	123	27.2%	17	23.9%	1396	34.3%		
6 上回答																								
男性	44	57.9%	59	49.2%	98	47.6%	100	39.5%	98	36.0%	46	23.4%	51	20.8%	59	14.8%	22	10.8%	3	16.7%	580	29.2%		
女性	38	55.9%	47	38.5%	69	39.9%	93	36.3%	111	33.5%	50	24.6%	47	18.4%	55	14.9%	43	17.3%	12	22.6%	565	27.2%		
男女合計	82	56.9%	106	43.8%	167	44.1%	193	37.9%	209	34.7%	96	24.0%	98	19.6%	114	14.9%	65	14.4%	15	21.1%	1145	28.2%		
無回答																								
男性	11	14.5%	23	19.2%	41	19.9%	57	22.5%	75	27.6%	70	35.5%	95	38.8%	203	51.0%	108	53.2%	11	61.1%	694	34.9%		
女性	8	11.8%	23	18.9%	23	13.3%	52	20.3%	74	22.4%	64	31.5%	113	44.3%	205	55.7%	144	57.8%	26	49.1%	732	35.2%		
男女合計	19	13.2%	46	19.0%	64	16.9%	109	21.4%	149	24.7%	134	33.5%	208	41.6%	408	53.3%	252	55.8%	37	52.1%	1426	35.1%		
全体(人)																								
男性	76		120		206		253		272		197		245		398		203		18		1988			
女性	68		122		173		256		331		203		255		368		249		53		2078			
男女合計	144		242		379		509		603		400		500		766		452		71		4066			

○公共交通機関

	10	割合	20	割合	30	割合	40	割合	50	割合	64	割合	69	割合	70	割合	80	割合	90	割合	全体数	割合		
1 上回答																								
男性	2	2.6%	1	0.8%	2	1.0%	3	1.2%	2	0.7%	1	0.5%	0	0.0%	0	0.0%	0	0.0%	0	0.0%	11	0.6%		
女性	0	0.0%	0	0.0%	1	0.6%	0	0.0%	0	0.0%	0	0.0%	0	0.0%	0	0.0%	2	0.8%	0	0.0%	3	0.1%		
男女合計	2	1.4%	1	0.4%	3	0.8%	3	0.6%	2	0.3%	1	0.3%	0	0.0%	0	0.0%	2	0.4%	0	0.0%	14	0.3%		
2 上回答																								
男性	1	1.3%	3	2.5%	1	0.5%	0	0.0%	1	0.4%	4	2.0%	3	1.2%	0	0.0%	0	0.0%	0	0.0%	13	0.7%		
女性	2	2.9%	0	0.0%	0	0.0%	1	0.4%	1	0.3%	1	0.5%	1	0.4%	0	0.0%	0	0.0%	0	0.0%	6	0.3%		
男女合計	3	2.1%	3	1.2%	1	0.3%	1	0.2%	2	0.3%	5	1.3%	4	0.8%	0	0.0%	0	0.0%	0	0.0%	19	0.5%		
3 上回答																								
男性	1	1.3%	2	1.7%	3	1.5%	3	1.2%	2	0.7%	3	1.5%	2	0.8%	2	0.5%	0	0.0%	0	0.0%	18	0.9%		
女性	0	0.0%	2	1.6%	0	0.0%	1	0.4%	1	0.3%	0	0.0%	2	0.8%	3	0.8%	0	0.0%	0	0.0%	9	0.4%		
男女合計	1	0.7%	4	1.7%	3	0.8%	4	0.8%	3	0.5%	3	0.8%	4	0.8%	5	0.7%	0	0.0%	0	0.0%	27	0.7%		
4 上回答																								
男性	4	5.3%	5	4.2%	10	4.9%	15	5.9%	14	5.1%	3	1.5%	4	1.6%	5	1.3%	5	2.5%	1	5.6%	66	3.3%		
女性	4	5.9%	3	2.5%	5	2.9%	7	2.7%	8	2.4%	4	2.0%	3	1.2%	5	1.4%	1	0.4%	0	0.0%	40	1.9%		
男女合計	8	5.6%	8	3.3%	15	4.0%	22	4.3%	22	3.6%	7	1.8%	7	1.4%	10	1.3%	6	1.3%	1	1.4%	106	2.6%		
5 上回答																								
男性	28	36.8%	38	31.7%	57	27.7%	80	31.6%	83	30.5%	53	26.9%	64	26.1%	99	24.9%	54	26.6%	1	5.6%	557	28.0%		
女性	30	44.1%	54	44.3%	68	39.3%	94	36.7%	110	33.2%	63	31.0%	65	25.5%	80	21.7%	34	13.7%	4	7.5%	602	29.0%		
男女合計	58	40.3%	92	38.0%	125	33.0%	174	34.2%	193	32.0%	116	29.0%	129	25.8%	179	23.4%	88	19.5%	5	7.0%	1159	28.5%		
6 上回答																								
男性	29	38.2%	48	40.0%	95	46.1%	95	37.5%	98	36.0%	65	33.0%	81	33.1%	89	22.4%	33	16.3%	4	22.2%	637	32.0%		
女性	24	35.3%	40	32.8%	77	44.5%	100	39.1%	135	40.8%	66	32.5%	71	27.8%	74	20.1%	56	22.5%	21	39.6%	664	32.0%		
男女合計	53	36.8%	88	36.4%	172	45.4%	195	38.3%	233	38.6%	131	32.8%	152	30.4%	163	21.3%	89	19.7%	25	35.2%	1301	32.0%		
無回答																								
男性	11	14.5%	23	19.2%	38	18.4%	57	22.5%	72	26.5%	68	34.5%	91	37.1%	203	51.0%	111	54.7%	12	66.7%	686	34.5%		
女性	8	11.8%	23	18.9%	22	12.7%	53	20.7%	76	23.0%	69	34.0%	113	44.3%	206	56.0%	156	62.7%	28	52.8%	754	36.3%		
男女合計	19	13.2%	46	19.0%	60	15.8%	110	21.6%	148	24.5%	137	34.3%	204	40.8%	409	53.4%	267	59.1%	40	56.3%	1440	35.4%		
全体(人)																								
男性	76		120		206		253		272		197		245		398		203		18		1988			
女性	68		122		173		256		331		203		255		368		249		53		2078			
男女合計	144		242		379		509		603		400		500		766		452		71		4066			

○路上

	10	割合	20	割合	30	割合	40	割合	50	割合	64	割合	69	割合	70	割合	80	割合	90	割合	全体数	割合		
1 上回答																								
男性	2	2.6%	2	1.7%	3	1.5%	5	2.0%	4	1.5%	3	1.5%	2	0.8%	7	1.8%	0	0.0%	0	0.0%	28	1.4%		
女性	2	2.9%	0	0.0%	1	0.6%	3	1.2%	6	1.8%	2	1.0%	4	1.6%	4	1.1%	3	1.2%	0	0.0%	25	1.2%		
男女合計	4	2.8%	2	0.8%	4	1.1%	8	1.6%	10	1.7%	5	1.3%	6	1.2%	11	1.4%	3	0.7%	0	0.0%	53	1.3%		
2 上回答																								
男性	6	7.9%	14	11.7%	7																			

○子供が利用する屋外の空間

	10	割合	20	割合	30	割合	40	割合	50	割合	64	割合	69	割合	70	割合	80	割合	90	割合	全体数	割合
1と回答																						
男性	2	2.6%	0	0.0%	0	0.0%	1	0.4%	1	0.4%	2	1.0%	0	0.0%	1	0.3%	0	0.0%	0	0.0%	7	0.4%
女性	1	1.5%	0	0.0%	0	0.0%	2	0.8%	2	0.6%	1	0.5%	0	0.0%	0	0.0%	2	0.8%	0	0.0%	8	0.4%
男女合計	3	2.1%	0	0.0%	0	0.0%	3	0.6%	3	0.5%	3	0.8%	0	0.0%	1	0.1%	2	0.4%	0	0.0%	15	0.4%
2と回答																						
男性	1	1.3%	3	2.5%	1	0.5%	2	0.8%	0	0.0%	3	1.5%	4	1.6%	0	0.0%	0	0.0%	0	0.0%	14	0.7%
女性	0	0.0%	1	0.8%	0	0.0%	1	0.4%	1	0.3%	0	0.0%	1	0.4%	1	0.3%	0	0.0%	0	0.0%	5	0.2%
男女合計	1	0.7%	4	1.7%	1	0.3%	3	0.6%	1	0.2%	3	0.8%	5	1.0%	1	0.1%	0	0.0%	0	0.0%	19	0.5%
3と回答																						
男性	0	0.0%	3	2.5%	3	1.5%	2	0.8%	2	0.7%	1	0.5%	1	0.4%	0	0.0%	0	0.0%	0	0.0%	12	0.6%
女性	0	0.0%	1	0.8%	2	1.2%	3	1.2%	0	0.0%	1	0.5%	1	0.4%	2	0.5%	0	0.0%	0	0.0%	10	0.5%
男女合計	0	0.0%	4	1.7%	5	1.3%	5	1.0%	2	0.3%	2	0.5%	2	0.4%	2	0.3%	0	0.0%	0	0.0%	22	0.5%
4と回答																						
男性	4	5.3%	3	2.5%	6	2.9%	6	2.4%	4	1.5%	1	0.5%	2	0.8%	1	0.3%	1	0.5%	0	0.0%	28	1.4%
女性	3	4.4%	4	3.3%	7	4.0%	10	3.9%	3	0.9%	0	0.0%	0	0.0%	3	0.8%	0	0.0%	0	0.0%	30	1.4%
男女合計	7	4.9%	7	2.9%	13	3.4%	16	3.1%	7	1.2%	1	0.3%	2	0.4%	4	0.5%	1	0.2%	0	0.0%	58	1.4%
5と回答																						
男性	19	25.0%	26	21.7%	59	28.6%	76	30.0%	54	19.9%	40	20.3%	59	24.1%	68	17.1%	45	22.2%	1	5.6%	447	22.5%
女性	18	26.5%	34	27.9%	62	35.8%	68	26.6%	86	26.0%	45	22.2%	52	20.4%	58	15.8%	28	11.2%	6	11.3%	457	22.0%
男女合計	37	25.7%	60	24.8%	121	31.9%	144	28.3%	140	23.2%	85	21.3%	111	22.2%	126	16.4%	73	16.2%	7	9.9%	904	22.2%
6と回答																						
男性	39	51.3%	60	50.0%	98	47.6%	106	41.9%	136	50.0%	74	37.6%	79	32.2%	109	27.4%	39	19.2%	5	27.8%	745	37.5%
女性	37	54.4%	58	47.5%	79	45.7%	119	46.5%	157	47.4%	84	41.4%	73	28.6%	83	22.6%	58	23.3%	19	35.8%	767	36.9%
男女合計	76	52.8%	118	48.8%	177	46.7%	225	44.2%	293	48.6%	158	39.5%	152	30.4%	192	25.1%	97	21.5%	24	33.8%	1512	37.2%
無回答																						
男性	11	14.5%	25	20.8%	39	18.9%	60	23.7%	75	27.6%	76	38.6%	100	40.8%	219	55.0%	118	58.1%	12	66.7%	735	37.0%
女性	9	13.2%	24	19.7%	23	13.3%	53	20.7%	82	24.8%	72	35.5%	128	50.2%	221	60.1%	161	64.7%	28	52.8%	801	38.5%
男女合計	20	13.9%	49	20.2%	62	16.4%	113	22.2%	157	26.0%	148	37.0%	228	45.6%	440	57.4%	279	61.7%	40	56.3%	1536	37.8%
全体(人)																						
男性	76		120		206		253		272		197		245		398		203		18		1988	
女性	68		122		173		256		331		203		255		368		249		53		2078	
男女合計	144		242		379		509		603		400		500		766		452		71		4066	

○健康増進施設

	10	割合	20	割合	30	割合	40	割合	50	割合	64	割合	69	割合	70	割合	80	割合	90	割合	全体数	割合
1と回答																						
男性	0	0.0%	0	0.0%	0	0.0%	1	0.4%	1	0.4%	1	0.5%	0	0.0%	0	0.0%	0	0.0%	0	0.0%	3	0.2%
女性	0	0.0%	0	0.0%	0	0.0%	1	0.4%	0	0.0%	0	0.0%	0	0.0%	0	0.0%	2	0.8%	0	0.0%	3	0.1%
男女合計	0	0.0%	0	0.0%	0	0.0%	2	0.4%	1	0.2%	1	0.3%	0	0.0%	0	0.0%	2	0.4%	0	0.0%	6	0.1%
2と回答																						
男性	0	0.0%	1	0.8%	1	0.5%	1	0.4%	0	0.0%	1	0.5%	1	0.4%	0	0.0%	0	0.0%	0	0.0%	5	0.3%
女性	0	0.0%	0	0.0%	0	0.0%	2	0.8%	0	0.0%	1	0.5%	0	0.0%	0	0.0%	0	0.0%	0	0.0%	3	0.1%
男女合計	0	0.0%	1	0.4%	1	0.3%	3	0.6%	0	0.0%	2	0.5%	1	0.2%	0	0.0%	0	0.0%	0	0.0%	8	0.2%
3と回答																						
男性	0	0.0%	0	0.0%	2	1.0%	2	0.8%	2	0.7%	1	0.5%	1	0.4%	1	0.3%	2	1.0%	0	0.0%	11	0.6%
女性	0	0.0%	0	0.0%	0	0.0%	1	0.4%	0	0.0%	0	0.0%	0	0.0%	1	0.3%	1	0.4%	0	0.0%	3	0.1%
男女合計	0	0.0%	0	0.0%	2	0.5%	3	0.6%	2	0.3%	1	0.3%	1	0.2%	2	0.3%	3	0.7%	0	0.0%	14	0.3%
4と回答																						
男性	0	0.0%	2	1.7%	5	2.4%	3	1.2%	3	1.1%	1	0.5%	3	1.2%	0	0.0%	1	0.5%	0	0.0%	18	0.9%
女性	0	0.0%	0	0.0%	1	0.6%	3	1.2%	2	0.6%	0	0.0%	0	0.0%	1	0.3%	0	0.0%	0	0.0%	7	0.3%
男女合計	0	0.0%	2	0.8%	6	1.6%	6	1.2%	5	0.8%	1	0.3%	3	0.6%	1	0.1%	1	0.2%	0	0.0%	25	0.6%
5と回答																						
男性	26	34.2%	24	20.0%	42	20.4%	49	19.4%	58	21.3%	32	16.2%	51	20.8%	57	14.3%	40	19.7%	1	5.6%	380	19.1%
女性	13	19.1%	23	18.9%	44	25.4%	57	22.3%	71	21.5%	44	21.7%	53	20.8%	56	15.2%	36	14.5%	5	9.4%	402	19.3%
男女合計	39	27.1%	47	19.4%	86	22.7%	106	20.8%	129	21.4%	76	19.0%	104	20.8%	113	14.8%	76	16.8%	6	8.5%	782	19.2%
6と回答																						
男性	39	51.3%	68	56.7%	117	56.8%	132	52.2%	131	48.2%	80	40.6%	89	36.3%	120	30.2%	40	19.7%	4	22.2%	820	41.2%
女性	45	66.2%	75	61.5%	105	60.7%	141	55.1%	171	51.7%	82	40.4%	75	29.4%	85	23.1%	53	21.3%	20	37.7%	852	41.0%
男女合計	84	58.3%	143	59.1%	222	58.6%	273	53.6%	302	50.1%	162	40.5%	164	32.8%	205	26.8%	93	20.6%	24	33.8%	1672	41.1%
無回答																						
男性	11	14.5%	25	20.8%	39	18.9%	65	25.7%	77	28.3%	81	41.1%	100	40.8%	220	55.3%	120	59.1%	13	72.2%	751	37.8%
女性	10	14.7%	24	19.7%	23	13.3%	51	19.9%	87	26.3%	76	37.4%	127	49.8%	225	61.1%	157	63.1%	28	52.8%	808	38.9%
男女合計	21	14.6%	49	20.2%	62	16.4%	116	22.8%	164	27.2%	157	39.3%	227	45.4%	445	58.1%	277	61.3%	41	57.7%	1559	38.3%
全体(人)																						
男性	76		120		206		253		272		197		245		398		203		18		1988	
女性	68		122		173		256		331		203		255		368		249		53		2078	
男女合計	144		242		379		509		603		400		500		766		452		71		4066	

14 「COPD（慢性閉塞性肺疾患）」の認知度（満15歳以上対象）（調査票 問14）

問14 あなたは、「COPD（慢性閉塞性肺疾患）」という病気を知っていましたか。（○は1つ）

1 知っている 2 知らない

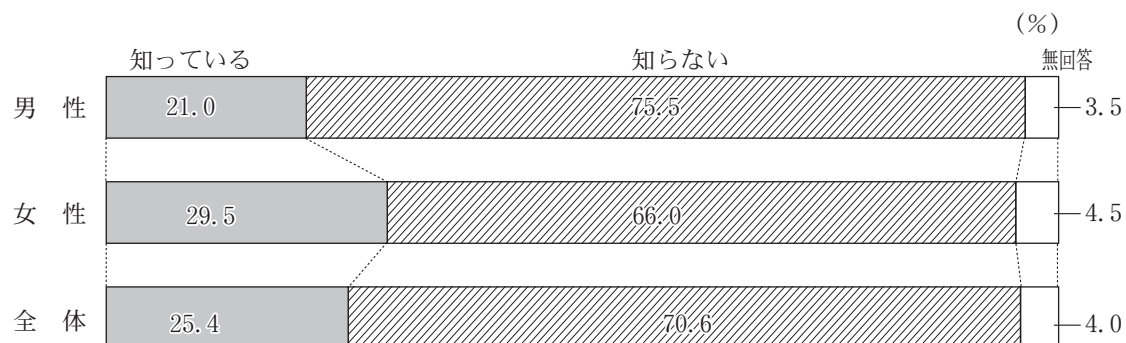

	10	割合	20	割合	30	割合	40	割合	50	割合	64	割合	69	割合	70	割合	80	割合	90	割合	全体数	割合
1と回答																						
男性	8	10.5%	23	19.2%	40	19.4%	78	30.8%	57	21.0%	47	23.9%	48	19.6%	86	21.6%	28	13.8%	3	16.7%	418	21.0%
女性	8	11.8%	47	38.5%	61	35.3%	101	39.5%	126	38.1%	62	30.5%	73	28.6%	98	26.6%	33	13.3%	4	7.5%	613	29.5%
男女合計	16	11.1%	70	28.9%	101	26.6%	179	35.2%	183	30.3%	109	27.3%	121	24.2%	184	24.0%	61	13.5%	7	9.9%	1031	25.4%
2と回答																						
男性	67	88.2%	91	75.8%	161	78.2%	163	64.4%	209	76.8%	146	74.1%	190	77.6%	298	74.9%	163	80.3%	12	66.7%	1500	75.5%
女性	58	85.3%	70	57.4%	110	63.6%	146	57.0%	192	58.0%	138	68.0%	175	68.6%	251	68.2%	193	77.5%	39	73.6%	1372	66.0%
男女合計	125	86.8%	161	66.5%	271	71.5%	309	60.7%	401	66.5%	284	71.0%	365	73.0%	549	71.7%	356	78.8%	51	71.8%	2872	70.6%
無回答																						
男性	1	1.3%	6	5.0%	5	2.4%	12	4.7%	6	2.2%	4	2.0%	7	2.9%	14	3.5%	12	5.9%	3	16.7%	70	3.5%
女性	2	2.9%	5	4.1%	2	1.2%	9	3.5%	13	3.9%	3	1.5%	7	2.7%	19	5.2%	23	9.2%	10	18.9%	93	4.5%
男女合計	3	2.1%	11	4.5%	7	1.8%	21	4.1%	19	3.2%	7	1.8%	14	2.8%	33	4.3%	35	7.7%	13	18.3%	163	4.0%
全体(人)																						
男性	76		120		206		253		272		197		245		398		203		18		1988	
女性	68		122		173		256		331		203		255		368		249		53		2078	
男女合計	144		242		379		509		603		400		500		766		452		71		4066	

県 北

	10	割合	20	割合	30	割合	40	割合	50	割合	64	割合	69	割合	70～	割合	全体数	割合
1と回答																		
男性	2	6.9%	7	18.4%	13	22.4%	25	35.2%	18	22.8%	12	21.4%	14	21.9%	32	18.8%	123	21.8%
女性	2	8.7%	13	28.9%	15	33.3%	29	42.6%	28	28.0%	14	28.0%	20	30.3%	32	17.7%	153	26.5%
男女合計	4	7.7%	20	24.1%	28	27.2%	54	38.8%	46	25.7%	26	24.5%	34	26.2%	64	18.2%	276	24.1%
2と回答																		
男性	26	89.7%	30	78.9%	43	74.1%	41	57.7%	59	74.7%	43	76.8%	48	75.0%	130	76.5%	420	74.3%
女性	19	82.6%	30	66.7%	28	62.2%	35	51.5%	69	69.0%	34	68.0%	42	63.6%	133	73.5%	390	67.5%
男女合計	45	86.5%	60	72.3%	71	68.9%	76	54.7%	128	71.5%	77	72.6%	90	69.2%	263	74.9%	810	70.9%
無回答																		
男性	1	3.4%	1	2.6%	2	3.4%	5	7.0%	2	2.5%	1	1.8%	2	3.1%	8	4.7%	22	3.9%
女性	2	8.7%	2	4.4%	2	4.4%	4	5.9%	3	3.0%	2	4.0%	4	6.1%	16	8.8%	35	6.1%
男女合計	3	5.8%	3	3.6%	4	3.9%	9	6.5%	5	2.8%	3	2.8%	6	4.6%	24	6.8%	57	5.0%
全体(人)																		
男性	29		38		58		71		79		56		64		170		565	
女性	23		45		45		68		100		50		66		181		578	
男女合計	52		83		103		139		179		106		130		351		1143	

県 中

	10	割合	20	割合	30	割合	40	割合	50	割合	64	割合	69	割合	70～	割合	全体数	割合
1と回答																		
男性	3	18.8%	2	8.3%	10	18.5%	20	28.2%	16	23.5%	13	29.5%	12	21.1%	18	16.4%	94	21.2%
女性	3	14.3%	11	34.4%	22	46.8%	30	42.9%	35	41.2%	17	36.2%	18	27.3%	21	19.8%	157	33.1%
男女合計	6	16.2%	13	23.2%	32	31.7%	50	35.5%	51	33.3%	30	33.0%	30	24.4%	39	18.1%	251	27.3%
2と回答																		
男性	13	81.3%	19	79.2%	44	81.5%	51	71.8%	51	75.0%	30	68.2%	42	73.7%	86	78.2%	336	75.7%
女性	18	85.7%	21	65.6%	25	53.2%	39	55.7%	46	54.1%	30	63.8%	47	71.2%	78	73.6%	304	64.1%
男女合計	31	83.8%	40	71.4%	69	68.3%	90	63.8%	97	63.4%	60	65.9%	89	72.4%	164	75.9%	640	69.7%
無回答																		
男性	0	0.0%	3	12.5%	0	0.0%	0	0.0%	1	1.5%	1	2.3%	3	5.3%	6	5.5%	14	3.2%
女性	0	0.0%	0	0.0%	0	0.0%	1	1.4%	4	4.7%	0	0.0%	1	1.5%	7	6.6%	13	2.7%
男女合計	0	0.0%	3	5.4%	0	0.0%	1	0.7%	5	3.3%	1	1.1%	4	3.3%	13	6.0%	27	2.9%
全体(人)																		
男性	16		24		54		71		68		44		57		110		444	
女性	21		32		47		70		85		47		66		106		474	
男女合計	37		56		101		141		153		91		123		216		918	

県 南

	10	割合	20	割合	30	割合	40	割合	50	割合	64	割合	69	割合	70～	割合	全体数	割合
1と回答																		
男性	0	0.0%	5	38.5%	1	8.3%	5	23.8%	3	10.3%	4	19.0%	4	16.0%	13	21.0%	35	19.0%
女性	0	0.0%	3	75.0%	6	60.0%	8	38.1%	14	50.0%	9	36.0%	10	38.5%	13	18.8%	63	33.7%
男女合計	0	0.0%	8	47.1%	7	31.8%	13	31.0%	17	29.8%	13	28.3%	14	27.5%	26	19.8%	98	26.4%
2と回答																		
男性	1	100.0%	8	61.5%	11	91.7%	16	76.2%	25	86.2%	17	81.0%	21	84.0%	48	77.4%	147	79.9%
女性	4	100.0%	1	25.0%	4	40.0%	13	61.9%	12	42.9%	16	64.0%	16	61.5%	50	72.5%	116	62.0%
男女合計	5	100.0%	9	52.9%	15	68.2%	29	69.0%	37	64.9%	33	71.7%	37	72.5%	98	74.8%	263	70.9%
無回答																		
男性	0	0.0%	0	0.0%	0	0.0%	0	0.0%	1	3.4%	0	0.0%	0	0.0%	1	1.6%	2	1.1%
女性	0	0.0%	0	0.0%	0	0.0%	0	0.0%	2	7.1%	0	0.0%	0	0.0%	6	8.7%	8	4.3%
男女合計	0	0.0%	0	0.0%	0	0.0%	0	0.0%	3	5.3%	0	0.0%	0	0.0%	7	5.3%	10	2.7%
全体(人)																		
男性	1		13		12		21		29		21		25		62		184	
女性	4		4		10		21		28		25		26		69		187	
男女合計	5		17		22		42		57		46		51		131		371	

会 津

	10	割合	20	割合	30	割合	40	割合	50	割合	64	割合	69	割合	70～	割合	全体数	割合
1と回答																		
男性	2	16.7%	2	15.4%	6	30.0%	9	36.0%	11	34.4%	8	22.9%	6	18.2%	25	21.0%	69	23.9%
女性	1	20.0%	8	57.1%	9	40.9%	12	44.4%	15	40.5%	9	28.1%	10	31.3%	27	20.8%	91	30.4%
男女合計	3	17.6%	10	37.0%	15	35.7%	21	40.4%	26	37.7%	17	25.4%	16	24.6%	52	20.9%	160	27.2%
2と回答																		
男性	10	83.3%	11	84.6%	12	60.0%	13	52.0%	20	62.5%	26	74.3%	26	78.8%	86	72.3%	204	70.6%
女性	4	80.0%	5	35.7%	13	59.1%	14	51.9%	20	54.1%	22	68.8%	21	65.6%	93	71.5%	192	64.2%
男女合計	14	82.4%	16	59.3%	25	59.5%	27	51.9%	40	58.0%	48	71.6%	47	72.3%	179	71.9%	396	67.3%
無回答																		
男性	0	0.0%	0	0.0%	2	10.0%	3	12.0%	1	3.1%	1	2.9%	1	3.0%	8	6.7%	16	5.5%
女性	0	0.0%	1	7.1%	0	0.0%	1	3.7%	2	5.4%	1	3.1%	1	3.1%	10	7.7%	16	5.4%
男女合計	0	0.0%	1	3.7%	2	4.8%	4	7.7%	3	4.3%	2	3.0%	2	3.1%	18	7.2%	32	5.4%
全体(人)																		
男性	12		13		20		25		32		35		33		119		289	
女性	5		14		22		27		37		32		32		130		299	
男女合計	17		27		42		52		69		67		65		249		588	

南会津

	10	割合	20	割合	30	割合	40	割合	50	割合	64	割合	69	割合	70～	割合	全体数	割合
1と回答																		
男性	0	0.0%	0	0.0%	0	0.0%	0	0.0%	1	33.3%	1	33.3%	2	50.0%	3	15.0%	7	18.4%
女性	0	0.0%	0	0.0%	0	0.0%	2	40.0%	2	66.7%	1	50.0%	2	33.3%	0	0.0%	7	20.0%
男女合計	0	0.0%	0	0.0%	0	0.0%	2	25.0%	3	50.0%	2	40.0%	4	40.0%	3	8.6%	14	19.2%
2と回答																		
男性	2	100.0%	2	100.0%	1	100.0%	3	100.0%	2	66.7%	1	33.3%	2	50.0%	16	80.0%	29	76.3%
女性	3	100.0%	0	0.0%	1	100.0%	3	60.0%	1	33.3%	1	50.0%	4	66.7%	11	73.3%	24	68.6%
男女合計	5	100.0%	2	100.0%	2	100.0%	6	75.0%	3	50.0%	2	40.0%	6	60.0%	27	77.1%	53	72.6%
無回答																		
男性	0	0.0%	0	0.0%	0	0.0%	0	0.0%	0	0.0%	1	33.3%	0	0.0%	1	5.0%	2	5.3%
女性	0	0.0%	0	0.0%	0	0.0%	0	0.0%	0	0.0%	0	0.0%	0	0.0%	4	26.7%	4	11.4%
男女合計	0	0.0%	0	0.0%	0	0.0%	0	0.0%	0	0.0%	1	20.0%	0	0.0%	5	14.3%	6	8.2%
全体(人)																		
男性	2		2		1		3		3		3		4		20		38	
女性	3		0		1		5		3		2		6		15		35	
男女合計	5		2		2		8		6		5		10		35		73	

相 双

	10	割合	20	割合	30	割合	40	割合	50	割合	64	割合	69	割合	70～	割合	全体数	割合
1と回答																		
男性	0	0.0%	4	44.4%	1	10.0%	3	37.5%	3	25.0%	4	30.8%	4	16.0%	5	12.8%	24	20.0%
女性	0	0.0%	2	40.0%	1	12.5%	3	27.3%	5	23.8%	5	33.3%	7	30.4%	8	16.7%	31	23.5%
男女合計	0	0.0%	6	42.9%	2	11.1%	6	31.6%	8	24.2%	9	32.1%	11	22.9%	13	14.9%	55	21.8%
2と回答																		
男性	4	100.0%	5	55.6%	9	90.0%	3	37.5%	9	75.0%	9	69.2%	20	80.0%	34	87.2%	93	77.5%
女性	1	100.0%	3	60.0%	7	87.5%	7	63.6%	16	76.2%	10	66.7%	16	69.6%	38	79.2%	98	74.2%
男女合計	5	100.0%	8	57.1%	16	88.9%	10	52.6%	25	75.8%	19	67.9%	36	75.0%	72	82.8%	191	75.8%
無回答																		
男性	0	0.0%	0	0.0%	0	0.0%	2	25.0%	0	0.0%	0	0.0%	1	4.0%	0	0.0%	3	2.5%
女性	0	0.0%	0	0.0%	0	0.0%	1	9.1%	0	0.0%	0	0.0%	0	0.0%	2	4.2%	3	2.3%
男女合計	0	0.0%	0	0.0%	0	0.0%	3	15.8%	0	0.0%	0	0.0%	1	2.1%	2	2.3%	6	2.4%
全体(人)																		
男性	4		9		10		8		12		13		25		39		120	
女性	1		5		8		11		21		15		23		48		132	
男女合計	5		14		18		19		33		28		48		87		252	

いわき

	10	割合	20	割合	30	割合	40	割合	50	割合	64	割合	69	割合	70～	割合	全体数	割合
1と回答																		
男性	1	8.3%	3	14.3%	9	17.6%	16	29.6%	5	10.2%	5	20.0%	6	16.2%	21	21.2%	66	19.0%
女性	2	18.2%	10	45.5%	8	20.0%	17	31.5%	27	47.4%	7	21.9%	6	16.7%	34	28.1%	111	29.8%
男女合計	3	13.0%	13	30.2%	17	18.7%	33	30.6%	32	30.2%	12	21.1%	12	16.4%	55	25.0%	177	24.5%
2と回答																		
男性	11	91.7%	16	76.2%	41	80.4%	36	66.7%	43	87.8%	20	80.0%	31	83.8%	73	73.7%	271	77.9%
女性	9	81.8%	10	45.5%	32	80.0%	35	64.8%	28	49.1%	25	78.1%	29	80.6%	80	66.1%	248	66.5%
男女合計	20	87.0%	26	60.5%	73	80.2%	71	65.7%	71	67.0%	45	78.9%	60	82.2%	153	69.5%	519	72.0%
無回答																		
男性	0	0.0%	2	9.5%	1	2.0%	2	3.7%	1	2.0%	0	0.0%	0	0.0%	5	5.1%	11	3.2%
女性	0	0.0%	2	9.1%	0	0.0%	2	3.7%	2	3.5%	0	0.0%	1	2.8%	7	5.8%	14	3.8%
男女合計	0	0.0%	4	9.3%	1	1.1%	4	3.7%	3	2.8%	0	0.0%	1	1.4%	12	5.5%	25	3.5%
全体(人)																		
男性	12		21		51		54		49		25		37		99		348	
女性	11		22		40		54		57		32		36		121		373	
男女合計	23		43		91		108		106		57		73		220		721	

全県(60歳以上・再掲)

	64	割合	69	割合	70	割合	80	割合	90	割合	全体数	割合
1と回答												
男性	47	23.9%	48	19.6%	86	21.6%	28	13.8%	3	16.7%	212	20.0%
女性	62	30.5%	73	28.6%	98	26.6%	33	13.3%	4	7.5%	270	23.9%
男女合計	109	27.3%	121	24.2%	184	24.0%	61	13.5%	7	9.9%	482	22.0%
2と回答												
男性	146	74.1%	190	77.6%	298	74.9%	163	80.3%	12	66.7%	809	76.2%
女性	138	68.0%	175	68.6%	251	68.2%	193	77.5%	39	73.6%	796	70.6%
男女合計	284	71.0%	365	73.0%	549	71.7%	356	78.8%	51	71.8%	1605	73.3%
無回答												
男性	4	2.0%	7	2.9%	14	3.5%	12	5.9%	3	16.7%	40	3.8%
女性	3	1.5%	7	2.7%	19	5.2%	23	9.2%	10	18.9%	62	5.5%
男女合計	7	1.8%	14	2.8%	33	4.3%	35	7.7%	13	18.3%	102	4.7%
全体(人)												
男性	197		245		398		203		18		1061	
女性	203		255		368		249		53		1128	
男女合計	400		500		766		452		71		2189	

15 飲酒の状況（満20歳以上対象）（調査票 問15）

（1） 飲酒の頻度

問15 あなたは、どのくらいお酒を飲んでいますか。あてはまる番号を1つ選んで○をつけてください。

- 1 毎日飲んでいる
- 2 週に5～6回飲んでいる
- 3 週に3～4回飲んでいる
- 4 たまに飲む程度
- 5 以前は飲んでいましたが、今は飲んでいない
- 6 もともと飲まない

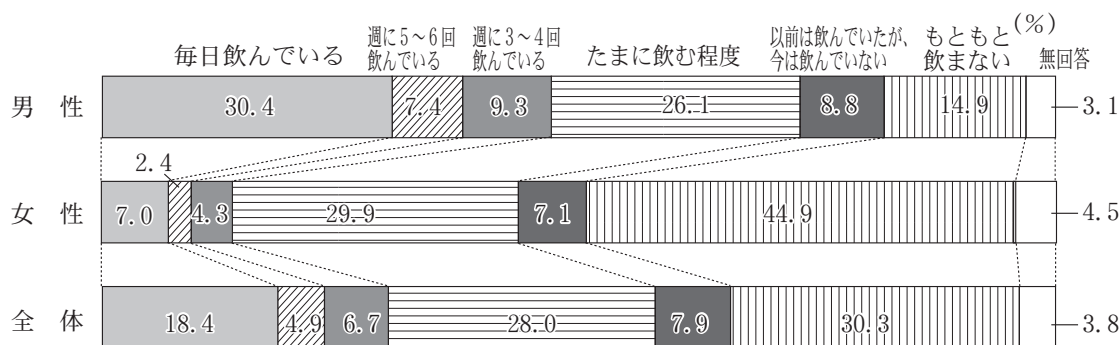

	20	割合	30	割合	40	割合	50	割合	64	割合	69	割合	70	割合	80	割合	90	割合	全体数	割合
1と回答																				
男性	6	5.0%	22	10.7%	79	31.2%	105	38.6%	74	37.6%	90	36.7%	145	36.4%	57	28.1%	3	16.7%	581	30.4%
女性	4	3.3%	10	5.8%	32	12.5%	35	10.6%	15	7.4%	17	6.7%	22	6.0%	3	1.2%	2	3.8%	140	7.0%
男女合計	10	4.1%	32	8.4%	111	21.8%	140	23.2%	89	22.3%	107	21.4%	167	21.8%	60	13.3%	5	7.0%	721	18.4%
2と回答																				
男性	4	3.3%	14	6.8%	23	9.1%	19	7.0%	19	9.6%	21	8.6%	39	9.8%	3	1.5%	0	0.0%	142	7.4%
女性	0	0.0%	8	4.6%	8	3.1%	16	4.8%	3	1.5%	7	2.7%	6	1.6%	1	0.4%	0	0.0%	49	2.4%
男女合計	4	1.7%	22	5.8%	31	6.1%	35	5.8%	22	5.5%	28	5.6%	45	5.9%	4	0.9%	0	0.0%	191	4.9%
3と回答																				
男性	11	9.2%	24	11.7%	27	10.7%	26	9.6%	23	11.7%	29	11.8%	27	6.8%	11	5.4%	0	0.0%	178	9.3%
女性	5	4.1%	8	4.6%	22	8.6%	20	6.0%	4	2.0%	13	5.1%	11	3.0%	3	1.2%	0	0.0%	86	4.3%
男女合計	16	6.6%	32	8.4%	49	9.6%	46	7.6%	27	6.8%	42	8.4%	38	5.0%	14	3.1%	0	0.0%	264	6.7%
4と回答																				
男性	68	56.7%	89	43.2%	79	31.2%	71	26.1%	57	28.9%	49	20.0%	60	15.1%	23	11.3%	3	16.7%	499	26.1%
女性	68	55.7%	69	39.9%	91	35.5%	121	36.6%	62	30.5%	64	25.1%	85	23.1%	38	15.3%	2	3.8%	600	29.9%
男女合計	136	56.2%	158	41.7%	170	33.4%	192	31.8%	119	29.8%	113	22.6%	145	18.9%	61	13.5%	5	7.0%	1099	28.0%
5と回答																				
男性	4	3.3%	6	2.9%	5	2.0%	18	6.6%	4	2.0%	22	9.0%	62	15.6%	40	19.7%	7	38.9%	168	8.8%
女性	9	7.4%	24	13.9%	17	6.6%	17	5.1%	22	10.8%	18	7.1%	16	4.3%	17	6.8%	2	3.8%	142	7.1%
男女合計	13	5.4%	30	7.9%	22	4.3%	35	5.8%	26	6.5%	40	8.0%	78	10.2%	57	12.6%	9	12.7%	310	7.9%
6と回答																				
男性	21	17.5%	46	22.3%	30	11.9%	27	9.9%	16	8.1%	28	11.4%	56	14.1%	57	28.1%	3	16.7%	284	14.9%
女性	29	23.8%	51	29.5%	78	30.5%	112	33.8%	95	46.8%	130	51.0%	206	56.0%	164	65.9%	38	71.7%	903	44.9%
男女合計	50	20.7%	97	25.6%	108	21.2%	139	23.1%	111	27.8%	158	31.6%	262	34.2%	221	48.9%	41	57.7%	1187	30.3%
無回答																				
男性	6	5.0%	5	2.4%	10	4.0%	6	2.2%	4	2.0%	6	2.4%	9	2.3%	12	5.9%	2	11.1%	60	3.1%
女性	7	5.7%	3	1.7%	8	3.1%	10	3.0%	2	1.0%	6	2.4%	22	6.0%	23	9.2%	9	17.0%	90	4.5%
男女合計	13	5.4%	8	2.1%	18	3.5%	16	2.7%	6	1.5%	12	2.4%	31	4.0%	35	7.7%	11	15.5%	150	3.8%
全体(人)																				
男性	120		206		253		272		197		245		398		203		18		1912	
女性	122		173		256		331		203		255		368		249		53		2010	
男女合計	242		379		509		603		400		500		766		452		71		3922	

県 北

	20	割合	30	割合	40	割合	50	割合	64	割合	69	割合	70～	割合	全体数	割合
1と回答																
男性	2	5.3%	6	10.3%	19	26.8%	34	43.0%	20	35.7%	20	31.3%	65	38.2%	166	31.0%
女性	2	4.4%	3	6.7%	7	10.3%	7	7.0%	5	10.0%	3	4.5%	9	5.0%	36	6.5%
男女合計	4	4.8%	9	8.7%	26	18.7%	41	22.9%	25	23.6%	23	17.7%	74	21.1%	202	18.5%
2と回答																
男性	0	0.0%	2	3.4%	6	8.5%	3	3.8%	5	8.9%	8	12.5%	13	7.6%	37	6.9%
女性	0	0.0%	2	4.4%	1	1.5%	3	3.0%	2	4.0%	1	1.5%	4	2.2%	13	2.3%
男女合計	0	0.0%	4	3.9%	7	5.0%	6	3.4%	7	6.6%	9	6.9%	17	4.8%	50	4.6%
3と回答																
男性	3	7.9%	8	13.8%	9	12.7%	9	11.4%	5	8.9%	10	15.6%	12	7.1%	56	10.4%
女性	3	6.7%	2	4.4%	4	5.9%	4	4.0%	0	0.0%	5	7.6%	3	1.7%	21	3.8%
男女合計	6	7.2%	10	9.7%	13	9.4%	13	7.3%	5	4.7%	15	11.5%	15	4.3%	77	7.1%
4と回答																
男性	23	60.5%	24	41.4%	26	36.6%	21	26.6%	19	33.9%	12	18.8%	27	15.9%	152	28.4%
女性	21	46.7%	23	51.1%	29	42.6%	36	36.0%	15	30.0%	13	19.7%	36	19.9%	173	31.2%
男女合計	44	53.0%	47	45.6%	55	39.6%	57	31.8%	34	32.1%	25	19.2%	63	17.9%	325	29.8%
5と回答																
男性	1	2.6%	3	5.2%	1	1.4%	2	2.5%	1	1.8%	7	10.9%	23	13.5%	38	7.1%
女性	5	11.1%	3	6.7%	5	7.4%	7	7.0%	6	12.0%	6	9.1%	12	6.6%	44	7.9%
男女合計	6	7.2%	6	5.8%	6	4.3%	9	5.0%	7	6.6%	13	10.0%	35	10.0%	82	7.5%
6と回答																
男性	8	21.1%	13	22.4%	5	7.0%	8	10.1%	5	8.9%	5	7.8%	24	14.1%	68	12.7%
女性	11	24.4%	9	20.0%	19	27.9%	41	41.0%	20	40.0%	35	53.0%	103	56.9%	238	42.9%
男女合計	19	22.9%	22	21.4%	24	17.3%	49	27.4%	25	23.6%	40	30.8%	127	36.2%	306	28.0%
無回答																
男性	1	2.6%	2	3.4%	5	7.0%	2	2.5%	1	1.8%	2	3.1%	6	3.5%	19	3.5%
女性	3	6.7%	3	6.7%	3	4.4%	2	2.0%	2	4.0%	3	4.5%	14	7.7%	30	5.4%
男女合計	4	4.8%	5	4.9%	8	5.8%	4	2.2%	3	2.8%	5	3.8%	20	5.7%	49	4.5%
全体(人)																
男性	38		58		71		79		56		64		170		536	
女性	45		45		68		100		50		66		181		555	
男女合計	83		103		139		179		106		130		351		1091	

県 中

	20	割合	30	割合	40	割合	50	割合	64	割合	69	割合	70～	割合	全体数	割合
1と回答																
男性	0	0.0%	6	11.1%	23	32.4%	25	36.8%	18	40.9%	23	40.4%	29	26.4%	124	29.0%
女性	1	3.1%	4	8.5%	8	11.4%	8	9.4%	1	2.1%	5	7.6%	5	4.7%	32	7.1%
男女合計	1	1.8%	10	9.9%	31	22.0%	33	21.6%	19	20.9%	28	22.8%	34	15.7%	156	17.7%
2と回答																
男性	1	4.2%	8	14.8%	11	15.5%	7	10.3%	4	9.1%	4	7.0%	12	10.9%	47	11.0%
女性	0	0.0%	3	6.4%	3	4.3%	6	7.1%	0	0.0%	1	1.5%	0	0.0%	13	2.9%
男女合計	1	1.8%	11	10.9%	14	9.9%	13	8.5%	4	4.4%	5	4.1%	12	5.6%	60	6.8%
3と回答																
男性	3	12.5%	7	13.0%	7	9.9%	5	7.4%	5	11.4%	6	10.5%	7	6.4%	40	9.3%
女性	1	3.1%	0	0.0%	10	14.3%	6	7.1%	1	2.1%	2	3.0%	4	3.8%	24	5.3%
男女合計	4	7.1%	7	6.9%	17	12.1%	11	7.2%	6	6.6%	8	6.5%	11	5.1%	64	7.3%
4と回答																
男性	14	58.3%	20	37.0%	19	26.8%	16	23.5%	12	27.3%	10	17.5%	12	10.9%	103	24.1%
女性	18	56.3%	15	31.9%	26	37.1%	30	35.3%	13	27.7%	20	30.3%	15	14.2%	137	30.2%
男女合計	32	57.1%	35	34.7%	45	31.9%	46	30.1%	25	27.5%	30	24.4%	27	12.5%	240	27.2%
5と回答																
男性	0	0.0%	2	3.7%	1	1.4%	3	4.4%	0	0.0%	3	5.3%	18	16.4%	27	6.3%
女性	2	6.3%	8	17.0%	4	5.7%	6	7.1%	5	10.6%	3	4.5%	3	2.8%	31	6.8%
男女合計	2	3.6%	10	9.9%	5	3.5%	9	5.9%	5	5.5%	6	4.9%	21	9.7%	58	6.6%
6と回答																
男性	3	12.5%	11	20.4%	10	14.1%	11	16.2%	4	9.1%	8	14.0%	27	24.5%	74	17.3%
女性	10	31.3%	17	36.2%	18	25.7%	26	30.6%	27	57.4%	34	51.5%	71	67.0%	203	44.8%
男女合計	13	23.2%	28	27.7%	28	19.9%	37	24.2%	31	34.1%	42	34.1%	98	45.4%	277	31.4%
無回答																
男性	3	12.5%	0	0.0%	0	0.0%	1	1.5%	1	2.3%	3	5.3%	5	4.5%	13	3.0%
女性	0	0.0%	0	0.0%	1	1.4%	3	3.5%	0	0.0%	1	1.5%	8	7.5%	13	2.9%
男女合計	3	5.4%	0	0.0%	1	0.7%	4	2.6%	1	1.1%	4	3.3%	13	6.0%	26	3.0%
全体(人)																
男性	24		54		71		68		44		57		110		428	
女性	32		47		70		85		47		66		106		453	
男女合計	56		101		141		153		91		123		216		881	

県 南

	20	割合	30	割合	40	割合	50	割合	64	割合	69	割合	70～	割合	全体数	割合
1と回答																
男性	1	7.7%	1	8.3%	5	23.8%	12	41.4%	10	47.6%	10	40.0%	20	32.3%	59	32.2%
女性	0	0.0%	1	10.0%	3	14.3%	5	17.9%	2	8.0%	2	7.7%	2	2.9%	15	8.2%
男女合計	1	5.9%	2	9.1%	8	19.0%	17	29.8%	12	26.1%	12	23.5%	22	16.8%	74	20.2%
2と回答																
男性	0	0.0%	2	16.7%	3	14.3%	2	6.9%	2	9.5%	2	8.0%	2	3.2%	13	7.1%
女性	0	0.0%	0	0.0%	0	0.0%	1	3.6%	0	0.0%	0	0.0%	0	0.0%	1	0.5%
男女合計	0	0.0%	2	9.1%	3	7.1%	3	5.3%	2	4.3%	2	3.9%	2	1.5%	14	3.8%
3と回答																
男性	2	15.4%	0	0.0%	3	14.3%	2	6.9%	2	9.5%	2	8.0%	3	4.8%	14	7.7%
女性	0	0.0%	1	10.0%	0	0.0%	2	7.1%	1	4.0%	3	11.5%	0	0.0%	7	3.8%
男女合計	2	11.8%	1	4.5%	3	7.1%	4	7.0%	3	6.5%	5	9.8%	3	2.3%	21	5.7%
4と回答																
男性	8	61.5%	4	33.3%	6	28.6%	6	20.7%	5	23.8%	4	16.0%	10	16.1%	43	23.5%
女性	2	50.0%	4	40.0%	10	47.6%	7	25.0%	8	32.0%	6	23.1%	12	17.4%	49	26.8%
男女合計	10	58.8%	8	36.4%	16	38.1%	13	22.8%	13	28.3%	10	19.6%	22	16.8%	92	25.1%
5と回答																
男性	0	0.0%	0	0.0%	1	4.8%	4	13.8%	0	0.0%	4	16.0%	12	19.4%	21	11.5%
女性	0	0.0%	1	10.0%	1	4.8%	1	3.6%	3	12.0%	2	7.7%	2	2.9%	10	5.5%
男女合計	0	0.0%	1	4.5%	2	4.8%	5	8.8%	3	6.5%	6	11.8%	14	10.7%	31	8.5%
6と回答																
男性	2	15.4%	5	41.7%	3	14.3%	2	6.9%	2	9.5%	3	12.0%	14	22.6%	31	16.9%
女性	2	50.0%	3	30.0%	7	33.3%	10	35.7%	11	44.0%	13	50.0%	48	69.6%	94	51.4%
男女合計	4	23.5%	8													

いわき

	20	割合	30	割合	40	割合	50	割合	64	割合	69	割合	70～	割合	全体数	割合
1と回答																
男性	0	0.0%	7	13.7%	23	42.6%	20	40.8%	11	44.0%	16	43.2%	29	29.3%	106	31.5%
女性	1	4.5%	2	5.0%	9	16.7%	11	19.3%	5	15.6%	1	2.8%	3	2.5%	32	8.8%
男女合計	1	2.3%	9	9.9%	32	29.6%	31	29.2%	16	28.1%	17	23.3%	32	14.5%	138	19.8%
2と回答																
男性	2	9.5%	2	3.9%	3	5.6%	2	4.1%	3	12.0%	3	8.1%	5	5.1%	20	6.0%
女性	0	0.0%	3	7.5%	3	5.6%	2	3.5%	0	0.0%	1	2.8%	0	0.0%	9	2.5%
男女合計	2	4.7%	5	5.5%	6	5.6%	4	3.8%	3	5.3%	4	5.5%	5	2.3%	29	4.2%
3と回答																
男性	1	4.8%	4	7.8%	5	9.3%	5	10.2%	1	4.0%	3	8.1%	10	10.1%	29	8.6%
女性	1	4.5%	0	0.0%	7	13.0%	4	7.0%	0	0.0%	1	2.8%	2	1.7%	15	4.1%
男女合計	2	4.7%	4	4.4%	12	11.1%	9	8.5%	1	1.8%	4	5.5%	12	5.5%	44	6.3%
4と回答																
男性	13	61.9%	25	49.0%	14	25.9%	15	30.6%	7	28.0%	3	8.1%	18	18.2%	95	28.3%
女性	13	59.1%	19	47.5%	12	22.2%	23	40.4%	7	21.9%	6	16.7%	26	21.5%	106	29.3%
男女合計	26	60.5%	44	48.4%	26	24.1%	38	35.8%	14	24.6%	9	12.3%	44	20.0%	201	28.8%
5と回答																
男性	3	14.3%	1	2.0%	0	0.0%	4	8.2%	1	4.0%	6	16.2%	19	19.2%	34	10.1%
女性	1	4.5%	4	10.0%	5	9.3%	1	1.8%	3	9.4%	4	11.1%	4	3.3%	22	6.1%
男女合計	4	9.3%	5	5.5%	5	4.6%	5	4.7%	4	7.0%	10	13.7%	23	10.5%	56	8.0%
6と回答																
男性	0	0.0%	11	21.6%	8	14.8%	2	4.1%	2	8.0%	6	16.2%	15	15.2%	44	13.1%
女性	4	18.2%	12	30.0%	17	31.5%	15	26.3%	17	53.1%	22	61.1%	77	63.6%	164	45.3%
男女合計	4	9.3%	23	25.3%	25	23.1%	17	16.0%	19	33.3%	28	38.4%	92	41.8%	208	29.8%
無回答																
男性	2	9.5%	1	2.0%	1	1.9%	1	2.0%	0	0.0%	0	0.0%	3	3.0%	8	2.4%
女性	2	9.1%	0	0.0%	1	1.9%	1	1.8%	0	0.0%	1	2.8%	9	7.4%	14	3.9%
男女合計	4	9.3%	1	1.1%	2	1.9%	2	1.9%	0	0.0%	1	1.4%	12	5.5%	22	3.2%
全体(人)																
男性	21		51		54		49		25		37		99		336	
女性	22		40		54		57		32		36		121		362	
男女合計	43		91		108		106		57		73		220		698	

(2) 飲酒の量 (調査票 問15付問)

付問 問15で1～4を選んだ方におたずねします。あなたが1回に飲む量はどれくらいですか。

「日本酒にあてはめて計算し、あてはまる番号を1つ選んで○をつけてください。(計算の仕方は、下記のとおりです。)

1 極少量	2 1合程度	3 2合程度	4 3合以上
-------	--------	--------	--------

焼酎1合は……………日本酒約1.5合に当たる。
 ビール1瓶は……………日本酒約1合に当たる。
 ウィスキーダブル1杯は…日本酒約1合に当たる。
 ワイングラス2杯は……………日本酒約1合に当たる。
 うすめて飲むときは、もとの量で計算してください。

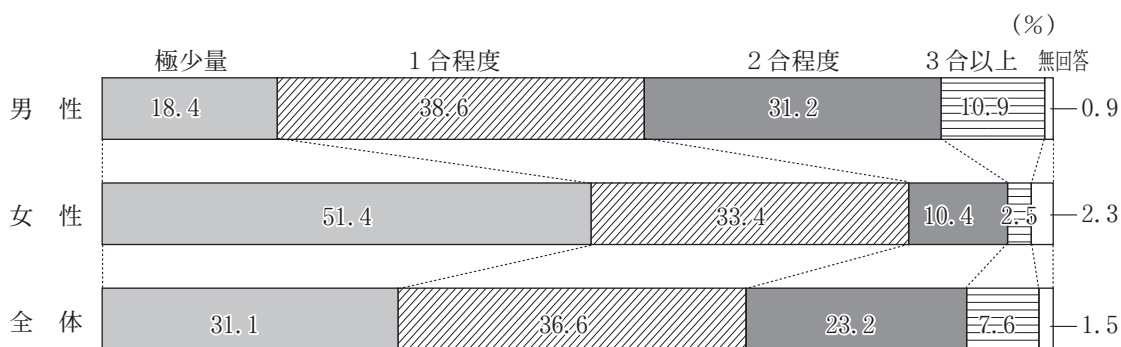

	20	割合	30	割合	40	割合	50	割合	64	割合	69	割合	70	割合	80	割合	90	割合	全体数	割合
1と回答																				
男性	26	29.2%	40	26.8%	35	16.8%	23	10.4%	25	14.5%	28	14.8%	57	21.0%	21	22.3%	2	33.3%	257	18.4%
女性	42	54.5%	47	49.5%	63	41.2%	86	44.8%	42	50.0%	63	62.4%	73	58.9%	31	68.9%	3	75.0%	450	51.4%
男女合計	68	41.0%	87	35.7%	98	27.1%	109	26.4%	67	26.1%	91	31.4%	130	32.9%	52	37.4%	5	50.0%	707	31.1%
2と回答																				
男性	29	32.6%	68	45.6%	81	38.9%	73	33.0%	59	34.1%	70	37.0%	110	40.6%	47	50.0%	4	66.7%	541	38.6%
女性	24	31.2%	29	30.5%	60	39.2%	75	39.1%	31	36.9%	24	23.8%	40	32.3%	8	17.8%	1	25.0%	292	33.4%
男女合計	53	31.9%	97	39.8%	141	39.1%	148	35.8%	90	35.0%	94	32.4%	150	38.0%	55	39.6%	5	50.0%	833	36.6%
3と回答																				
男性	20	22.5%	24	16.1%	63	30.3%	86	38.9%	60	34.7%	74	39.2%	89	32.8%	21	22.3%	0	0.0%	437	31.2%
女性	7	9.1%	14	14.7%	25	16.3%	24	12.5%	7	8.3%	7	6.9%	6	4.8%	1	2.2%	0	0.0%	91	10.4%
男女合計	27	16.3%	38	15.6%	88	24.4%	110	26.6%	67	26.1%	81	27.9%	95	24.1%	22	15.8%	0	0.0%	528	23.2%
4と回答																				
男性	13	14.6%	15	10.1%	28	13.5%	37	16.7%	27	15.6%	16	8.5%	12	4.4%	4	4.3%	0	0.0%	152	10.9%
女性	4	5.2%	4	4.2%	4	2.6%	7	3.6%	1	1.2%	1	1.0%	1	0.8%	0	0.0%	0	0.0%	22	2.5%
男女合計	17	10.2%	19	7.8%	32	8.9%	44	10.7%	28	10.9%	17	5.9%	13	3.3%	4	2.9%	0	0.0%	174	7.6%
無回答																				
男性	1	1.1%	2	1.3%	1	0.5%	2	0.9%	2	1.2%	1	0.5%	3	1.1%	1	1.1%	0	0.0%	13	0.9%
女性	0	0.0%	1	1.1%	1	0.7%	0	0.0%	3	3.6%	6	5.9%	4	3.2%	5	11.1%	0	0.0%	20	2.3%
男女合計	1	0.6%	3	1.2%	2	0.6%	2	0.5%	5	1.9%	7	2.4%	7	1.8%	6	4.3%	0	0.0%	33	1.5%
全体(人)																				
男性	89		149		208		221		173		189		271		94		6		1400	
女性	77		95		153		192		84		101		124		45		4		875	
男女合計	166		244		361		413		257		290		395		139		10		2275	

県 北

	20	割合	30	割合	40	割合	50	割合	64	割合	69	割合	70～	割合	全体数	割合
1と回答																
男性	10	35.7%	15	37.5%	13	21.7%	7	10.4%	8	16.3%	9	18.0%	23	19.7%	85	20.7%
女性	16	61.5%	17	56.7%	20	48.8%	21	42.0%	9	40.9%	15	68.2%	30	57.7%	128	52.7%
男女合計	26	48.1%	32	45.7%	33	32.7%	28	23.9%	17	23.9%	24	33.3%	53	31.4%	213	32.6%
2と回答																
男性	8	28.6%	20	50.0%	26	43.3%	21	31.3%	21	42.9%	15	30.0%	54	46.2%	165	40.1%
女性	8	30.8%	8	26.7%	17	41.5%	22	44.0%	11	50.0%	3	13.6%	14	26.9%	83	34.2%
男女合計	16	29.6%	28	40.0%	43	42.6%	43	36.8%	32	45.1%	18	25.0%	68	40.2%	248	37.9%
3と回答																
男性	5	17.9%	3	7.5%	16	26.7%	23	34.3%	10	20.4%	21	42.0%	35	29.9%	113	27.5%
女性	2	7.7%	4	13.3%	3	7.3%	6	12.0%	1	4.5%	1	4.5%	2	3.8%	19	7.8%
男女合計	7	13.0%	7	10.0%	19	18.8%	29	24.8%	11	15.5%	22	30.6%	37	21.9%	132	20.2%
4と回答																
男性	4	14.3%	2	5.0%	4	6.7%	15	22.4%	9	18.4%	5	10.0%	4	3.4%	43	10.5%
女性	0	0.0%	1	3.3%	0	0.0%	1	2.0%	0	0.0%	1	4.5%	1	1.9%	4	1.6%
男女合計	4	7.4%	3	4.3%	4	4.0%	16	13.7%	9	12.7%	6	8.3%	5	3.0%	47	7.2%
無回答																
男性	1	3.6%	0	0.0%	1	1.7%	1	1.5%	1	2.0%	0	0.0%	1	0.9%	5	1.2%
女性	0	0.0%	0	0.0%	1	2.4%	0	0.0%	1	4.5%	2	9.1%	5	9.6%	9	3.7%
男女合計	1	1.9%	0	0.0%	2	2.0%	1	0.9%	2	2.8%	2	2.8%	6	3.6%	14	2.1%
全体(人)																
男性	28		40		60		67		49		50		117		411	
女性	26		30		41		50		22		22		52		243	
男女合計	54		70		101		117		71		72		169		654	

県 中

	20	割合	30	割合	40	割合	50	割合	64	割合	69	割合	70～	割合	全体数	割合
1と回答																
男性	6	33.3%	6	14.6%	9	15.0%	5	9.4%	4	10.3%	5	11.6%	11	18.3%	46	14.6%
女性	10	50.0%	8	36.4%	14	29.8%	20	40.0%	8	53.3%	19	67.9%	13	54.2%	92	44.7%
男女合計	16	42.1%	14	22.2%	23	21.5%	25	24.3%	12	22.2%	24	33.8%	24	28.6%	138	26.5%
2と回答																
男性	7	38.9%	21	51.2%	22	36.7%	16	30.2%	15	38.5%	17	39.5%	29	48.3%	127	40.4%
女性	5	25.0%	10	45.5%	20	42.6%	19	38.0%	6	40.0%	5	17.9%	8	33.3%	73	35.4%
男女合計	12	31.6%	31	49.2%	42	39.3%	35	34.0%	21	38.9%	22	31.0%	37	44.0%	200	38.5%
3と回答																
男性	3	16.7%	12	29.3%	21	35.0%	22	41.5%	14	35.9%	16	37.2%	14	23.3%	102	32.5%
女性	3	15.0%	4	18.2%	10	21.3%	10	20.0%	0	0.0%	3	10.7%	2	8.3%	32	15.5%
男女合計	6	15.8%	16	25.4%	31	29.0%	32	31.1%	14	25.9%	19	26.8%	16	19.0%	134	25.8%
4と回答																
男性	2	11.1%	0	0.0%	8	13.3%	10	18.9%	6	15.4%	4	9.3%	6	10.0%	36	11.5%
女性	2	10.0%	0	0.0%	3	6.4%	1	2.0%	0	0.0%	0	0.0%	0	0.0%	6	2.9%
男女合計	4	10.5%	0	0.0%	11	10.3%	11	10.7%	6	11.1%	4	5.6%	6	7.1%	42	8.1%
無回答																
男性	0	0.0%	2	4.9%	0	0.0%	0	0.0%	0	0.0%	1	2.3%	0	0.0%	3	1.0%
女性	0	0.0%	0	0.0%	0	0.0%	0	0.0%	1	6.7%	1	3.6%	1	4.2%	3	1.5%
男女合計	0	0.0%	2	3.2%	0	0.0%	0	0.0%	1	1.9%	2	2.8%	1	1.2%	6	1.2%
全体(人)																
男性	18		41		60		53		39		43		60		314	
女性	20		22		47		50		15		28		24		206	
男女合計	38		63		107		103		54		71		84		520	

県 南

	20	割合	30	割合	40	割合	50	割合	64	割合	69	割合	70～	割合	全体数	割合
1と回答																
男性	3	27.3%	3	42.9%	2	11.8%	2	9.1%	2	10.5%	4	22.2%	11	31.4%	27	20.9%
女性	2	100.0%	4	66.7%	7	53.8%	7	46.7%	5	45.5%	6	54.5%	11	78.6%	42	58.3%
男女合計	5	38.5%	7	53.8%	9	30.0%	9	24.3%	7	23.3%	10	34.5%	22	44.9%	69	34.3%
2と回答																
男性	3	27.3%	1	14.3%	8	47.1%	10	45.5%	6	31.6%	6	33.3%	11	31.4%	45	34.9%
女性	0	0.0%	0	0.0%	3	23.1%	5	33.3%	4	36.4%	4	36.4%	3	21.4%	19	26.4%
男女合計	3	23.1%	1	7.7%	11	36.7%	15	40.5%	10	33.3%	10	34.5%	14	28.6%	64	31.8%
3と回答																
男性	3	27.3%	0	0.0%	5	29.4%	8	36.4%	5	26.3%	5	27.8%	10	28.6%	36	27.9%
女性	0	0.0%	2	33.3%	3	23.1%	2	13.3%	0	0.0%	0	0.0%	0	0.0%	7	9.7%
男女合計	3	23.1%	2	15.4%	8	26.7%	10	27.0%	5	16.7%	5	17.2%	10	20.4%	43	21.4%
4と回答																
男性	2	18.2%	3	42.9%	2	11.8%	2	9.1%	6	31.6%	3	16.7%	2	5.7%	20	15.5%
女性	0	0.0%	0	0.0%	0	0.0%	1	6.7%	1	9.1%	0	0.0%	0	0.0%	2	2.8%
男女合計	2	15.4%	3	23.1%	2	6.7%	3	8.1%	7	23.3%	3	10.3%	2	4.1%	22	10.9%
無回答																
男性	0	0.0%	0	0.0%	0	0.0%	0	0.0%	0	0.0%	0	0.0%	1	2.9%	1	0.8%
女性	0	0.0%	0	0.0%	0	0.0%	0	0.0%	1	9.1%	1	9.1%	0	0.0%	2	2.8%
男女合計	0	0.0%	0	0.0%	0	0.0%	0	0.0%	1	3.3%	1	3.4%	1	2.0%	3	1.5%
全体(人)																
男性	11		7		17		22		19		18		35		129	
女性	2		6		13		15		11		11		14		72	
男女合計	13		13		30		37		30		29		49		201	

会 津

	20	割合	30	割合	40	割合	50	割合	64	割合	69	割合	70～	割合	全体数	割合
1と回答																
男性	2	25.0%	3	18.8%	5	29.4%	4	17.4%	5	16.7%	5	16.7%	12	17.4%	36	18.7%
女性	5	45.5%	4	40.0%	5	41.7%	12	54.5%	14	73.7%	12	70.6%	20	57.1%	72	57.1%
男女合計	7	36.8%	7	26.9%	10	34.5%	16	35.6%	19	38.8%	17	36.2%	32	30.8%	108	33.9%
2と回答																
男性	1	12.5%	9	56.3%	4	23.5%	8	34.8%	7	23.3%	12	40.0%	30	43.5%	71	36.8%
女性	5	45.5%	4	40.0%	6	50.0%	7	31.8%	3	15.8%	3	17.6%	15	42.9%	43	34.1%
男女合計	6	31.6%	13	50.0%	10	34.5%	15	33.3%	10	20.4%	15	31.9%	45	43.3%	114	35.7%
3と回答																
男性	4	50.0%	3	18.8%	3	17.6%	9	39.1%	13	43.3%	12	40.0%	24	34.8%	68	35.2%
女性	0	0.0%	1	10.0%	1	8.3%	2	9.1%	2	10.5%	0	0.0%	0	0.0%	6	4.8%
男女合計	4	21.1%	4	15.4%	4	13.8%	11	24.4%	15	30.6%	12	25.5%	24	23.1%	74	23.2%
4と回答																
男性	1	12.5%	1	6.3%	5	29.4%	2	8.7%	5	16.7%	1	3.3%	3	4.3%	18	9.3%
女性	1	9.1%	1	10.0%	0	0.0%	1	4.5%	0	0.0%	0	0.0%	0	0.0%	3	2.4%
男女合計	2	10.5%	2	7.7%	5	17.2%	3	6.7%	5	10.2%	1	2.1%	3	2.9%	21	6.6%
無回答																
男性	0	0.0%	0	0.0%	0	0.0%	0	0.0%	0	0.0%	0	0.0%	0	0.0%	0	0.0%
女性	0	0.0%	0	0.0%	0	0.0%	0	0.0%	0	0.0%	2	11.8%	0	0.0%	2	1.6%
男女合計	0	0.0%	0	0.0%	0	0.0%	0	0.0%	0	0.0%	2	4.3%	0	0.0%	2	0.6%
全体(人)																
男性	8		16		17		23		30		30		69		193	
女性	11		10		12		22		19		17		35		126	
男女合計	19		26		29		45		49		47		104		319	

南 会 津

	20	割合	30	割合	40	割合	50	割合	64	割合	69	割合	70～	割合	全体数	割合
1と回答																
男性	1	50.0%	1	100.0%	1	33.3%	0	0.0%	0	0.0%	0	0.0%	2	16.7%	5	18.5%
女性	0	0.0%	0	0.0%	2	50.0%	2	66.7%	0	0.0%	0	0.0%	1	33.3%	5	50.0%
男女合計	1	50.0%	1	100.0%	3	42.9%	2	33.3%	0	0.0%	0	0.0%	3	20.0%	10	27.0%
2と回答																
男性	0	0.0%	0	0.0%	1	33.3%	0	0.0%	0	0.0%	3	75.0%	5	41.7%	9	33.3%
女性	0	0.0%	0	0.0%	1	25.0%	1	33.3%	0	0.0%	0	0.0%	1	33.3%	3	30.0%
男女合計	0	0.0%	0	0.0%	2	28.6%	1	16.7%	0	0.0%	3	75.0%	6	40.0%	12	32.4%
3と回答																
男性	0	0.0%	0	0.0%	1	33.3%	3	100.0%	2	100.0%	1	25.0%	5	41.7%	12	44.4%
女性	0	0.0%	0	0.0%	1	25.0%	0	0.0%	0	0.0%	0	0.0%	1	33.3%	2	20.0%
男女合計	0	0.0%	0	0.0%	2	28.6%	3	50.0%	2	100.0%	1	25.0%	6	40.0%	14	37.8%
4と回答																
男性	1	50.0%	0	0.0%	0	0.0%	0	0.0%	0	0.0%	0	0.0%	0	0.0%	1	3.7%
女性	0	0.0%	0	0.0%	0	0.0%	0	0.0%	0	0.0%	0	0.0%	0	0.0%	0	0.0%
男女合計	1	50.0%	0	0.0%	0	0.0%	0	0.0%	0	0.0%	0	0.0%	0	0.0%	1	2.7%
無回答																
男性	0	0.0%	0	0.0%	0	0.0%	0	0.0%	0	0.0%	0	0.0%	0	0.0%	0	0.0%
女性	0	0.0%	0	0.0%	0	0.0%	0	0.0%	0	0.0%	0	0.0%	0	0.0%	0	0.0%
男女合計	0	0.0%	0	0.0%	0	0.0%	0	0.0%	0	0.0%	0	0.0%	0	0.0%	0	0.0%
全体(人)																
男性	2		1		3		3		2		4		12		27	
女性	0		0		4		3		0		0		3		10	
男女合計	2		1		7		6		2		4		15		37	

相 双

	20	割合	30	割合	40	割合	50	割合	64	割合	69	割合	70～	割合	全体数	割合
1と回答																
男性	1	16.7%	0	0.0%	0	0.0%	1	9.1%	0	0.0%	2	10.5%	4	25.0%	8	10.5%
女性	2	66.7%	1	33.3%	2	40.0%	4	33.3%	2	40.0%	7	50.0%	10	71.4%	28	50.0%
男女合計	3	33.3%	1	11.1%	2	18.2%	5	21.7%	2	11.8%	9	27.3%	14	46.7%	36	27.3%
2と回答																
男性	1	16.7%	4	66.7%	3	50.0%	4	36.4%	6	50.0%	8	42.1%	7	43.8%	33	43.4%
女性	1	33.3%	1	33.3%	2	40.0%	6	50.0%	2	40.0%	5	35.7%	3	21.4%	20	35.7%
男女合計	2	22.2%	5	55.6%	5	45.5%	10	43.5%	8	47.1%	13	39.4%	10	33.3%	53	40.2%
3と回答																
男性	3	50.0%	2	33.3%	1	16.7%	5	45.5%	4	33.3%	7	36.8%	4	25.0%	26	34.2%
女性	0	0.0%	0	0.0%	1	20.0%	1	8.3%	1	20.0%	2	14.3%	1	7.1%	6	10.7%
男女合計	3	33.3%	2	22.2%	2	18.2%	6	26.1%	5	29.4%	9	27.3%	5	16.7%	32	24.2%
4と回答																
男性	1	16.7%	0	0.0%	2	33.3%	1	9.1%	1	8.3%	2	10.5%	0	0.0%	7	9.2%
女性	0	0.0%	1	33.3%	0	0.0%	1	8.3%	0	0.0%	0	0.0%	0	0.0%	2	3.6%
男女合計	1	11.1%	1	11.1%	2	18.2%	2	8.7%	1	5.9%	2	6.1%	0	0.0%	9	6.8%
無回答																
男性	0	0.0%	0	0.0%	0	0.0%	0	0.0%	1	8.3%	0	0.0%	1	6.3%	2	2.6%
女性	0	0.0%	0	0.0%	0	0.0%	0	0.0%	0	0.0%	0	0.0%	0	0.0%	0	0.0%
男女合計	0	0.0%	0	0.0%	0	0.0%	0	0.0%	1	5.9%	0	0.0%	1	3.3%	2	1.5%
全体(人)																
男性	6		6		6		11		12		19		16		76	
女性	3		3		5		12		5		14		14		56	
男女合計	9		9		11		23		17		33		30		132	

いわき

	20	割合	30	割合	40	割合	50	割合	64	割合	69	割合	70～	割合	全体数	割合
1と回答																
男性	3	18.8%	12	31.6%	5	11.1%	4	9.5%	6	27.3%	3	12.0%	17	27.4%	50	20.0%
女性	7	46.7%	13	54.2%	13	41.9%	20	50.0%	4	33.3%	4	44.4%	22	71.0%	83	51.2%
男女合計	10	32.3%	25	40.3%	18	23.7%	24	29.3%	10	29.4%	7	20.6%	39	41.9%	133	32.3%
2と回答																
男性	9	56.3%	13	34.2%	17	37.8%	14	33.3%	4	18.2%	9	36.0%	25	40.3%	91	36.4%
女性	5	33.3%	6	25.0%	11	35.5%	15	37.5%	5	41.7%	4	44.4%	5	16.1%	51	31.5%
男女合計	14	45.2%	19	30.6%	28	36.8%	29	35.4%	9	26.5%	13	38.2%	30	32.3%	142	34.5%
3と回答																
男性	2	12.5%	4	10.5%	16	35.6%	16	38.1%	12	54.5%	12	48.0%	18	29.0%	80	32.0%
女性	2	13.3%	3	12.5%	6	19.4%	3	7.5%	3	25.0%	1	11.1%	1	3.2%	19	11.7%
男女合計	4	12.9%	7	11.3%	22	28.9%	19	23.2%	15	44.1%	13	38.2%	19	20.4%	99	24.0%
4と回答																
男性	2	12.5%	9	23.7%	7	15.6%	7	16.7%	0	0.0%	1	4.0%	1	1.6%	27	10.8%
女性	1	6.7%	1	4.2%	1	3.2%	2	5.0%	0	0.0%	0	0.0%	0	0.0%	5	3.1%
男女合計	3	9.7%	10	16.1%	8	10.5%	9	11.0%	0	0.0%	1	2.9%	1	1.1%	32	7.8%
無回答																
男性	0	0.0%	0	0.0%	0	0.0%	1	2.4%	0	0.0%	0	0.0%	1	1.6%	2	0.8%
女性	0	0.0%	1	4.2%	0	0.0%	0	0.0%	0	0.0%	0	0.0%	3	9.7%	4	2.5%
男女合計	0	0.0%	1	1.6%	0	0.0%	1	1.2%	0	0.0%	0	0.0%	4	4.3%	6	1.5%
全体(人)																
男性	16		38		45		42		22		25		62		250	
女性	15		24		31		40		12		9		31		162	
男女合計	31		62		76		82		34		34		93		412	

(3) 飲酒の状況

(「(1) 飲酒の頻度」及び「(2) 飲酒の量」の回答に関するクロス集計)

	20	割合	30	割合	40	割合	50	割合	64	割合	69	割合	70	割合	80	割合	90	割合	全体数	割合
毎日、極少量お酒を飲んでいる。																				
男性	0	0.0%	0	0.0%	3	1.2%	3	1.1%	4	2.0%	4	1.6%	13	3.3%	9	4.4%	0	0.0%	36	1.9%
女性	3	2.5%	1	0.6%	4	1.6%	5	1.5%	4	2.0%	5	2.0%	5	1.4%	2	0.8%	2	3.8%	31	1.5%
男女合計	3	1.2%	1	0.3%	7	1.4%	8	1.3%	8	2.0%	9	1.8%	18	2.3%	11	2.4%	2	2.8%	67	1.7%
毎日、1合程度お酒を飲んでいる。																				
男性	2	1.7%	14	6.8%	35	13.8%	22	8.1%	16	8.1%	26	10.6%	57	14.3%	26	12.8%	3	16.7%	201	10.5%
女性	0	0.0%	4	2.3%	16	6.3%	21	6.3%	7	3.4%	6	2.4%	11	3.0%	1	0.4%	0	0.0%	66	3.3%
男女合計	2	0.8%	18	4.7%	51	10.0%	43	7.1%	23	5.8%	32	6.4%	68	8.9%	27	6.0%	3	4.2%	267	6.8%
毎日、2合程度お酒を飲んでいる。																				
男性	2	1.7%	5	2.4%	26	10.3%	53	19.5%	37	18.8%	50	20.4%	66	16.6%	18	8.9%	0	0.0%	257	13.4%
女性	0	0.0%	4	2.3%	10	3.9%	7	2.1%	3	1.5%	5	2.0%	5	1.4%	0	0.0%	0	0.0%	34	1.7%
男女合計	2	0.8%	9	2.4%	36	7.1%	60	10.0%	40	10.0%	55	11.0%	71	9.3%	18	4.0%	0	0.0%	291	7.4%
毎日、3合以上お酒を飲んでいる。																				
男性	2	1.7%	3	1.5%	15	5.9%	27	9.9%	17	8.6%	10	4.1%	9	2.3%	4	2.0%	0	0.0%	87	4.6%
女性	1	0.8%	1	0.6%	2	0.8%	2	0.6%	1	0.5%	1	0.4%	1	0.3%	0	0.0%	0	0.0%	9	0.4%
男女合計	3	1.2%	4	1.1%	17	3.3%	29	4.8%	18	4.5%	11	2.2%	10	1.3%	4	0.9%	0	0.0%	96	2.4%
毎日、お酒を飲んでいる。(飲む量未回答)																				
男性	0	0.0%	0	0.0%	0	0.0%	0	0.0%	0	0.0%	0	0.0%	0	0.0%	0	0.0%	0	0.0%	0	0.0%
女性	0	0.0%	0	0.0%	0	0.0%	0	0.0%	0	0.0%	0	0.0%	0	0.0%	0	0.0%	0	0.0%	0	0.0%
男女合計	0	0.0%	0	0.0%	0	0.0%	0	0.0%	0	0.0%	0	0.0%	0	0.0%	0	0.0%	0	0.0%	0	0.0%
週に5～6回、極少量お酒を飲んでいる。																				
男性	1	0.8%	2	1.0%	1	0.4%	0	0.0%	0	0.0%	1	0.4%	10	2.5%	1	0.5%	0	0.0%	16	0.8%
女性	0	0.0%	3	1.7%	3	1.2%	3	0.9%	1	0.5%	4	1.6%	3	0.8%	1	0.4%	0	0.0%	18	0.9%
男女合計	1	0.4%	5	1.3%	4	0.8%	3	0.5%	1	0.3%	5	1.0%	13	1.7%	2	0.4%	0	0.0%	34	0.9%
週に5～6回、1合程度お酒を飲んでいる。																				
男性	3	2.5%	8	3.9%	8	3.2%	7	2.6%	9	4.6%	11	4.5%	18	4.5%	2	1.0%	0	0.0%	66	3.5%
女性	0	0.0%	4	2.3%	3	1.2%	9	2.7%	2	1.0%	3	1.2%	3	0.8%	0	0.0%	0	0.0%	24	1.2%
男女合計	3	1.2%	12	3.2%	11	2.2%	16	2.7%	11	2.8%	14	2.8%	21	2.7%	2	0.4%	0	0.0%	90	2.3%
週に5～6回、2合程度お酒を飲んでいる。																				
男性	0	0.0%	2	1.0%	14	5.5%	10	3.7%	9	4.6%	7	2.9%	11	2.8%	0	0.0%	0	0.0%	53	2.8%
女性	0	0.0%	1	0.6%	1	0.4%	4	1.2%	0	0.0%	0	0.0%	0	0.0%	0	0.0%	0	0.0%	6	0.3%
男女合計	0	0.0%	3	0.8%	15	2.9%	14	2.3%	9	2.3%	7	1.4%	11	1.4%	0	0.0%	0	0.0%	59	1.5%
週に5～6回、3合以上お酒を飲んでいる。																				
男性	0	0.0%	1	0.5%	0	0.0%	2	0.7%	1	0.5%	2	0.8%	0	0.0%	0	0.0%	0	0.0%	6	0.3%
女性	0	0.0%	0	0.0%	1	0.4%	0	0.0%	0	0.0%	0	0.0%	0	0.0%	0	0.0%	0	0.0%	1	0.0%
男女合計	0	0.0%	1	0.3%	1	0.2%	2	0.3%	1	0.3%	2	0.4%	0	0.0%	0	0.0%	0	0.0%	7	0.2%

	20	割合	30	割合	40	割合	50	割合	64	割合	69	割合	70	割合	80	割合	90	割合	全体数	割合		
週に5～6回、お酒を飲んでいる。(飲む量未回答)																						
男性	0	0.0%	1	0.5%	0	0.0%	0	0.0%	0	0.0%	0	0.0%	0	0.0%	0	0.0%	0	0.0%	1	0.1%		
女性	0	0.0%	0	0.0%	0	0.0%	0	0.0%	0	0.0%	0	0.0%	0	0.0%	0	0.0%	0	0.0%	0	0.0%		
男女合計	0	0.0%	1	0.3%	0	0.0%	0	0.0%	0	0.0%	0	0.0%	0	0.0%	0	0.0%	0	0.0%	1	0.0%		
週に3～4回、極少量お酒を飲んでいる。																						
男性	2	1.7%	3	1.5%	4	1.6%	1	0.4%	2	1.0%	4	1.6%	6	1.5%	1	0.5%	0	0.0%	23	1.2%		
女性	2	1.6%	2	1.2%	5	2.0%	6	1.8%	1	0.5%	7	2.7%	7	1.9%	1	0.4%	0	0.0%	31	1.5%		
男女合計	4	1.7%	5	1.3%	9	1.8%	7	1.2%	3	0.8%	11	2.2%	13	1.7%	2	0.4%	0	0.0%	54	1.4%		
週に3～4回、1合程度お酒を飲んでいる。																						
男性	6	5.0%	14	6.8%	13	5.1%	9	3.3%	12	6.1%	14	5.7%	9	2.3%	8	3.9%	0	0.0%	85	4.4%		
女性	0	0.0%	4	2.3%	12	4.7%	10	3.0%	3	1.5%	5	2.0%	4	1.1%	1	0.4%	0	0.0%	39	1.9%		
男女合計	6	2.5%	18	4.7%	25	4.9%	19	3.2%	15	3.8%	19	3.8%	13	1.7%	9	2.0%	0	0.0%	124	3.2%		
週に3～4回、2合程度お酒を飲んでいる。																						
男性	3	2.5%	5	2.4%	7	2.8%	11	4.0%	6	3.0%	8	3.3%	9	2.3%	2	1.0%	0	0.0%	51	2.7%		
女性	2	1.6%	1	0.6%	4	1.6%	3	0.9%	0	0.0%	0	0.0%	0	0.0%	1	0.4%	0	0.0%	11	0.5%		
男女合計	5	2.1%	6	1.6%	11	2.2%	14	2.3%	6	1.5%	8	1.6%	9	1.2%	3	0.7%	0	0.0%	62	1.6%		
週に3～4回、3合以上お酒を飲んでいる。																						
男性	0	0.0%	2	1.0%	3	1.2%	3	1.1%	3	1.5%	3	1.2%	2	0.5%	0	0.0%	0	0.0%	16	0.8%		
女性	1	0.8%	1	0.6%	1	0.4%	1	0.3%	0	0.0%	0	0.0%	0	0.0%	0	0.0%	0	0.0%	4	0.2%		
男女合計	1	0.4%	3	0.8%	4	0.8%	4	0.7%	3	0.8%	3	0.6%	2	0.3%	0	0.0%	0	0.0%	20	0.5%		
週に3～4回、お酒を飲んでいる。(飲む量未回答)																						
男性	0	0.0%	0	0.0%	0	0.0%	2	0.7%	0	0.0%	0	0.0%	1	0.3%	0	0.0%	0	0.0%	3	0.2%		
女性	0	0.0%	0	0.0%	0	0.0%	0	0.0%	0	0.0%	1	0.4%	0	0.0%	0	0.0%	0	0.0%	1	0.0%		
男女合計	0	0.0%	0	0.0%	0	0.0%	2	0.3%	0	0.0%	1	0.2%	1	0.1%	0	0.0%	0	0.0%	4	0.1%		
たまに、極少量お酒を飲んでいる。																						
男性	23	19.2%	35	17.0%	27	10.7%	19	7.0%	19	9.6%	19	7.8%	28	7.0%	10	4.9%	2	11.1%	182	9.5%		
女性	37	30.3%	41	23.7%	51	19.9%	72	21.8%	36	17.7%	47	18.4%	58	15.8%	27	10.8%	1	1.9%	370	18.4%		
男女合計	60	24.8%	76	20.1%	78	15.3%	91	15.1%	55	13.8%	66	13.2%	86	11.2%	37	8.2%	3	4.2%	552	14.1%		
たまに、1合程度お酒を飲んでいる。																						
男性	18	15.0%	32	15.5%	25	9.9%	35	12.9%	22	11.2%	19	7.8%	26	6.5%	11	5.4%	1	5.6%	189	9.9%		
女性	24	19.7%	17	9.8%	29	11.3%	35	10.6%	19	9.4%	10	3.9%	22	6.0%	6	2.4%	1	1.9%	163	8.1%		
男女合計	42	17.4%	49	12.9%	54	10.6%	70	11.6%	41	10.3%	29	5.8%	48	6.3%	17	3.8%	2	2.8%	352	9.0%		
たまに、2合程度お酒を飲んでいる。																						
男性	15	12.5%	12	5.8%	16	6.3%	12	4.4%	8	4.1%	9	3.7%	3	0.8%	1	0.5%	0	0.0%	76	4.0%		
女性	5	4.1%	8	4.6%	10	3.9%	10	3.0%	4	2.0%	2	0.8%	1	0.3%	0	0.0%	0	0.0%	40	2.0%		
男女合計	20	8.3%	20	5.3%	26	5.1%	22	3.6%	12	3.0%	11	2.2%	4	0.5%	1	0.2%	0	0.0%	116	3.0%		
たまに、3合以上お酒を飲んでいる。																						
男性	11	9.2%	9	4.4%	10	4.0%	5	1.8%	6	3.0%	1	0.4%	1	0.3%	0	0.0%	0	0.0%	43	2.2%		
女性	2	1.6%	2	1.2%	0	0.0%	4	1.2%	0	0.0%	0	0.0%	0	0.0%	0	0.0%	0	0.0%	8	0.4%		
男女合計	13	5.4%	11	2.9%	10	2.0%	9	1.5%	6	1.5%	1	0.2%	1	0.1%	0	0.0%	0	0.0%	51	1.3%		
たまに、お酒を飲んでいる。(飲む量未回答)																						
男性	1	0.8%	1	0.5%	1	0.4%	0	0.0%	2	1.0%	1	0.4%	2	0.5%	1	0.5%	0	0.0%	9	0.5%		
女性	0	0.0%	1	0.6%	1	0.4%	0	0.0%	3	1.5%	5	2.0%	4	1.1%	5	2.0%	0	0.0%	19	0.9%		
男女合計	1	0.4%	2	0.5%	2	0.4%	0	0.0%	5	1.3%	6	1.2%	6	0.8%	6	1.3%	0	0.0%	28	0.7%		
*参考 以前は飲んでいたが、今は飲んでいない。																						
男性	4	3.3%	6	2.9%	5	2.0%	18	6.6%	4	2.0%	22	9.0%	62	15.6%	40	19.7%	7	38.9%	168	8.8%		
女性	9	7.4%	24	13.9%	17	6.6%	17	5.1%	22	10.8%	18	7.1%	16	4.3%	17	6.8%	2	3.8%	142	7.1%		
男女合計	13	5.4%	30	7.9%	22	4.3%	35	5.8%	26	6.5%	40	8.0%	78	10.2%	57	12.6%	9	12.7%	310	7.9%		
*参考 もともと飲まない。																						
男性	21	17.5%	46	22.3%	30	11.9%	27	9.9%	16	8.1%	28	11.4%	56	14.1%	57	28.1%	3	16.7%	284	14.9%		
女性	29	23.8%	51	29.5%	78	30.5%	112	33.8%	95	46.8%	130	51.0%	206	56.0%	164	65.9%	38	71.7%	903	44.9%		
男女合計	50	20.7%	97	25.6%	108	21.2%	139	23.1%	111	27.8%	158	31.6%	262	34.2%	221	48.9%	41	57.7%	1187	30.3%		
無回答																						
男性	6	5.0%	5	2.4%	10	4.0%	6	2.2%	4	2.0%	6	2.4%	9	2.3%	12	5.9%	2	11.1%	60	3.1%		
女性	7	5.7%	3	1.7%	8	3.1%	10	3.0%	2	1.0%	6	2.4%	22	6.0%	23	9.2%	9	17.0%	90	4.5%		
男女合計	13	5.4%	8	2.1%	18	3.5%	16	2.7%	6	1.5%	12	2.4%	31	4.0%	35	7.7%	11	15.5%	150	3.8%		
全体(人)																						
男性	120		206		253		272		197		245		398		203		18		1912			
女性	122		173		256		331		203		255		368		249		53		2010			
男女合計	242		379		509		603		400		500		766		452		71		3922			

16 定期的な歯科検診（満15歳以上対象）（調査票 問16）

問16 あなたは定期的に歯科健診（歯石の除去、歯面清掃を含む）を受けていますか。

1 はい 2 いいえ

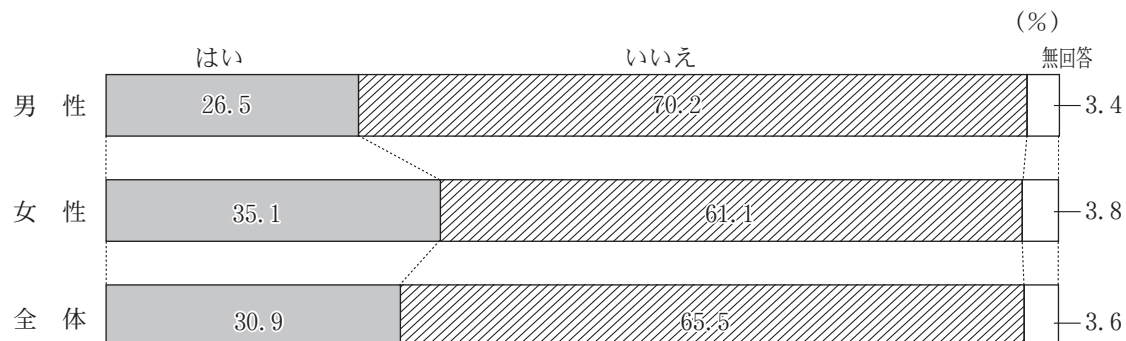

	10	割合	20	割合	30	割合	40	割合	50	割合	64	割合	69	割合	70	割合	80	割合	90	割合	全体数	割合
1と回答																						
男性	26	34.2%	20	16.7%	43	20.9%	54	21.3%	68	25.0%	64	32.5%	75	30.6%	115	28.9%	58	28.6%	3	16.7%	526	26.5%
女性	24	35.3%	25	20.5%	63	36.4%	106	41.4%	131	39.6%	81	39.9%	103	40.4%	138	37.5%	55	22.1%	3	5.7%	729	35.1%
男女合計	50	34.7%	45	18.6%	106	28.0%	160	31.4%	199	33.0%	145	36.3%	178	35.6%	253	33.0%	113	25.0%	6	8.5%	1255	30.9%
2と回答																						
男性	49	64.5%	94	78.3%	157	76.2%	189	74.7%	197	72.4%	129	65.5%	163	66.5%	271	68.1%	133	65.5%	13	72.2%	1395	70.2%
女性	43	63.2%	92	75.4%	108	62.4%	141	55.1%	190	57.4%	120	59.1%	145	56.9%	217	59.0%	173	69.5%	41	77.4%	1270	61.1%
男女合計	92	63.9%	186	76.9%	265	69.9%	330	64.8%	387	64.2%	249	62.3%	308	61.6%	488	63.7%	306	67.7%	54	76.1%	2665	65.5%
無回答																						
男性	1	1.3%	6	5.0%	6	2.9%	10	4.0%	7	2.6%	4	2.0%	7	2.9%	12	3.0%	12	5.9%	2	11.1%	67	3.4%
女性	1	1.5%	5	4.1%	2	1.2%	9	3.5%	10	3.0%	2	1.0%	7	2.7%	13	3.5%	21	8.4%	9	17.0%	79	3.8%
男女合計	2	1.4%	11	4.5%	8	2.1%	19	3.7%	17	2.8%	6	1.5%	14	2.8%	25	3.3%	33	7.3%	11	15.5%	146	3.6%
全体(人)																						
男性	76		120		206		253		272		197		245		398		203		18		1988	
女性	68		122		173		256		331		203		255		368		249		53		2078	
男女合計	144		242		379		509		603		400		500		766		452		71		4066	

県 北

	10	割合	20	割合	30	割合	40	割合	50	割合	64	割合	69	割合	70～	割合	全体数	割合
1と回答																		
男性	6	20.7%	11	28.9%	12	20.7%	8	11.3%	22	27.8%	20	35.7%	24	37.5%	44	25.9%	147	26.0%
女性	11	47.8%	9	20.0%	16	35.6%	29	42.6%	40	40.0%	17	34.0%	28	42.4%	62	34.3%	212	36.7%
男女合計	17	32.7%	20	24.1%	28	27.2%	37	26.6%	62	34.6%	37	34.9%	52	40.0%	106	30.2%	359	31.4%
2と回答																		
男性	22	75.9%	26	68.4%	44	75.9%	58	81.7%	55	69.6%	35	62.5%	38	59.4%	119	70.0%	397	70.3%
女性	11	47.8%	34	75.6%	27	60.0%	36	52.9%	58	58.0%	32	64.0%	35	53.0%	107	59.1%	340	58.8%
男女合計	33	63.5%	60	72.3%	71	68.9%	94	67.6%	113	63.1%	67	63.2%	73	56.2%	226	64.4%	737	64.5%
無回答																		
男性	1	3.4%	1	2.6%	2	3.4%	5	7.0%	2	2.5%	1	1.8%	2	3.1%	7	4.1%	21	3.7%
女性	1	4.3%	2	4.4%	2	4.4%	3	4.4%	2	2.0%	1	2.0%	3	4.5%	12	6.6%	26	4.5%
男女合計	2	3.8%	3	3.6%	4	3.9%	8	5.8%	4	2.2%	2	1.9%	5	3.8%	19	5.4%	47	4.1%
全体(人)																		
男性	29		38		58		71		79		56		64		170		565	
女性	23		45		45		68		100		50		66		181		578	
男女合計	52		83		103		139		179		106		130		351		1143	

県 中

	10	割合	20	割合	30	割合	40	割合	50	割合	64	割合	69	割合	70～	割合	全体数	割合
1と回答																		
男性	8	50.0%	1	4.2%	11	20.4%	15	21.1%	24	35.3%	12	27.3%	14	24.6%	38	34.5%	123	27.7%
女性	6	28.6%	5	15.6%	16	34.0%	31	44.3%	36	42.4%	17	36.2%	29	43.9%	27	25.5%	167	35.2%
男女合計	14	37.8%	6	10.7%	27	26.7%	46	32.6%	60	39.2%	29	31.9%	43	35.0%	65	30.1%	290	31.6%
2と回答																		
男性	8	50.0%	20	83.3%	42	77.8%	56	78.9%	42	61.8%	31	70.5%	40	70.2%	68	61.8%	307	69.1%
女性	15	71.4%	27	84.4%	31	66.0%	37	52.9%	46	54.1%	29	61.7%	36	54.5%	74	69.8%	295	62.2%
男女合計	23	62.2%	47	83.9%	73	72.3%	93	66.0%	88	57.5%	60	65.9%	76	61.8%	142	65.7%	602	65.6%
無回答																		
男性	0	0.0%	3	12.5%	1	1.9%	0	0.0%	2	2.9%	1	2.3%	3	5.3%	4	3.6%	14	3.2%
女性	0	0.0%	0	0.0%	0	0.0%	2	2.9%	3	3.5%	1	2.1%	1	1.5%	5	4.7%	12	2.5%
男女合計	0	0.0%	3	5.4%	1	1.0%	2	1.4%	5	3.3%	2	2.2%	4	3.3%	9	4.2%	26	2.8%
全体(人)																		
男性	16		24		54		71		68		44		57		110		444	
女性	21		32		47		70		85		47		66		106		474	
男女合計	37		56		101		141		153		91		123		216		918	

県 南

	10	割合	20	割合	30	割合	40	割合	50	割合	64	割合	69	割合	70～	割合	全体数	割合
1と回答																		
男性	1	100.0%	3	23.1%	3	25.0%	6	28.6%	7	24.1%	4	19.0%	9	36.0%	19	30.6%	52	28.3%
女性	2	50.0%	0	0.0%	1	10.0%	10	47.6%	11	39.3%	11	44.0%	11	42.3%	24	34.8%	70	37.4%
男女合計	3	60.0%	3	17.6%	4	18.2%	16	38.1%	18	31.6%	15	32.6%	20	39.2%	43	32.8%	122	32.9%
2と回答																		
男性	0	0.0%	10	76.9%	9	75.0%	15	71.4%	21	72.4%	17	81.0%	16	64.0%	43	69.4%	131	71.2%
女性	2	50.0%	4	100.0%	9	90.0%	10	47.6%	15	53.6%	14	56.0%	15	57.7%	39	56.5%	108	57.8%
男女合計	2	40.0%	14	82.4%	18	81.8%	25	59.5%	36	63.2%	31	67.4%	31	60.8%	82	62.6%	239	64.4%
無回答																		
男性	0	0.0%	0	0.0%	0	0.0%	0	0.0%	1	3.4%	0	0.0%	0	0.0%	0	0.0%	1	0.5%
女性	0	0.0%	0	0.0%	0	0.0%	1	4.8%	2	7.1%	0	0.0%	0	0.0%	6	8.7%	9	4.8%
男女合計	0	0.0%	0	0.0%	0	0.0%	1	2.4%	3	5.3%	0	0.0%	0	0.0%	6	4.6%	10	2.7%
全体(人)																		
男性	1		13		12		21		29		21		25		62		184	
女性	4		4		10		21		28		25		26		69		187	
男女合計	5		17		22		42		57		46		51		131		371	

会 津

	10	割合	20	割合	30	割合	40	割合	50	割合	64	割合	69	割合	70～	割合	全体数	割合
1と回答																		
男性	4	33.3%	1	7.7%	4	20.0%	6	24.0%	5	15.6%	11	31.4%	10	30.3%	30	25.2%	71	24.6%
女性	1	20.0%	4	28.6%	9	40.9%	7	25.9%	11	29.7%	15	46.9%	10	31.3%	28	21.5%	85	28.4%
男女合計	5	29.4%	5	18.5%	13	31.0%	13	25.0%	16	23.2%	26	38.8%	20	30.8%	58	23.3%	156	26.5%
2と回答																		
男性	8	66.7%	12	92.3%	14	70.0%	17	68.0%	26	81.3%	23	65.7%	22	66.7%	80	67.2%	202	69.9%
女性	4	80.0%	9	64.3%	13	59.1%	19	70.4%	24	64.9%	17	53.1%	21	65.6%	93	71.5%	200	66.9%
男女合計	12	70.6%	21	77.8%	27	64.3%	36	69.2%	50	72.5%	40	59.7%	43	66.2%	173	69.5%	402	68.4%
無回答																		
男性	0	0.0%	0	0.0%	2	10.0%	2	8.0%	1	3.1%	1	2.9%	1	3.0%	9	7.6%	16	5.5%
女性	0	0.0%	1	7.1%	0	0.0%	1	3.7%	2	5.4%	0	0.0%	1	3.1%	9	6.9%	14	4.7%
男女合計	0	0.0%	1	3.7%	2	4.8%	3	5.8%	3	4.3%	1	1.5%	2	3.1%	18	7.2%	30	5.1%
全体(人)																		
男性	12		13		20		25		32		35		33		119		289	
女性	5		14		22		27		37		32		32		130		299	
男女合計	17		27		42		52		69		67		65		249		588	

南会津

	10	割合	20	割合	30	割合	40	割合	50	割合	64	割合	69	割合	70～	割合	全体数	割合
1と回答																		
男性	0	0.0%	1	50.0%	1	100.0%	1	33.3%	0	0.0%	1	33.3%	2	50.0%	5	25.0%	11	28.9%
女性	1	33.3%	0	0.0%	0	0.0%	1	20.0%	1	33.3%	1	50.0%	2	33.3%	3	20.0%	9	25.7%
男女合計	1	20.0%	1	50.0%	1	50.0%	2	25.0%	1	16.7%	2	40.0%	4	40.0%	8	22.9%	20	27.4%
2と回答																		
男性	2	100.0%	1	50.0%	0	0.0%	2	66.7%	3	100.0%	1	33.3%	2	50.0%	15	75.0%	26	68.4%
女性	2	66.7%	0	0.0%	1	100.0%	4	80.0%	2	66.7%	1	50.0%	4	66.7%	9	60.0%	23	65.7%
男女合計	4	80.0%	1	50.0%	1	50.0%	6	75.0%	5	83.3%	2	40.0%	6	60.0%	24	68.6%	49	67.1%
無回答																		
男性	0	0.0%	0	0.0%	0	0.0%	0	0.0%	0	0.0%	1	33.3%	0	0.0%	0	0.0%	1	2.6%
女性	0	0.0%	0	0.0%	0	0.0%	0	0.0%	0	0.0%	0	0.0%	0	0.0%	3	20.0%	3	8.6%
男女合計	0	0.0%	0	0.0%	0	0.0%	0	0.0%	0	0.0%	1	20.0%	0	0.0%	3	8.6%	4	5.5%
全体(人)																		
男性	2		2		1		3		3		3		4		20		38	
女性	3		0		1		5		3		2		6		15		35	
男女合計	5		2		2		8		6		5		10		35		73	

相 双

	10	割合	20	割合	30	割合	40	割合	50	割合	64	割合	69	割合	70～	割合	全体数	割合
1と回答																		
男性	1	25.0%	2	22.2%	1	10.0%	2	25.0%	1	8.3%	9	69.2%	8	32.0%	12	30.8%	36	30.0%
女性	0	0.0%	2	40.0%	2	25.0%	7	63.6%	8	38.1%	7	46.7%	12	52.2%	14	29.2%	52	39.4%
男女合計	1	20.0%	4	28.6%	3	16.7%	9	47.4%	9	27.3%	16	57.1%	20	41.7%	26	29.9%	88	34.9%
2と回答																		
男性	3	75.0%	7	77.8%	9	90.0%	4	50.0%	11	91.7%	4	30.8%	16	64.0%	27	69.2%	81	67.5%
女性	1	100.0%	3	60.0%	6	75.0%	3	27.3%	13	61.9%	8	53.3%	11	47.8%	33	68.8%	78	59.1%
男女合計	4	80.0%	10	71.4%	15	83.3%	7	36.8%	24	72.7%	12	42.9%	27	56.3%	60	69.0%	159	63.1%
無回答																		
男性	0	0.0%	0	0.0%	0	0.0%	2	25.0%	0	0.0%	0	0.0%	1	4.0%	0	0.0%	3	2.5%
女性	0	0.0%	0	0.0%	0	0.0%	1	9.1%	0	0.0%	0	0.0%	0	0.0%	1	2.1%	2	1.5%
男女合計	0	0.0%	0	0.0%	0	0.0%	3	15.8%	0	0.0%	0	0.0%	1	2.1%	1	1.1%	5	2.0%
全体(人)																		
男性	4		9		10		8		12		13		25		39		120	
女性	1		5		8		11		21		15		23		48		132	
男女合計	5		14		18		19		33		28		48		87		252	

いわき

	10	割合	20	割合	30	割合	40	割合	50	割合	64	割合	69	割合	70～	割合	全体数	割合
1と回答																		
男性	6	50.0%	1	4.8%	11	21.6%	16	29.6%	9	18.4%	7	28.0%	8	21.6%	28	28.3%	86	24.7%
女性	3	27.3%	5	22.7%	19	47.5%	21	38.9%	24	42.1%	13	40.6%	11	30.6%	38	31.4%	134	35.9%
男女合計	9	39.1%	6	14.0%	30	33.0%	37	34.3%	33	31.1%	20	35.1%	19	26.0%	66	30.0%	220	30.5%
2と回答																		
男性	6	50.0%	18	85.7%	39	76.5%	37	68.5%	39	79.6%	18	72.0%	29	78.4%	65	65.7%	251	72.1%
女性	8	72.7%	15	68.2%	21	52.5%	32	59.3%	32	56.1%	19	59.4%	23	63.9%	76	62.8%	226	60.6%
男女合計	14	60.9%	33	76.7%	60	65.9%	69	63.9%	71	67.0%	37	64.9%	52	71.2%	141	64.1%	477	66.2%
無回答																		
男性	0	0.0%	2	9.5%	1	2.0%	1	1.9%	1	2.0%	0	0.0%	0	0.0%	6	6.1%	11	3.2%
女性	0	0.0%	2	9.1%	0	0.0%	1	1.9%	1	1.8%	0	0.0%	2	5.6%	7	5.8%	13	3.5%
男女合計	0	0.0%	4	9.3%	1	1.1%	2	1.9%	2	1.9%	0	0.0%	2	2.7%	13	5.9%	24	3.3%
全体(人)																		
男性	12		21		51		54		49		25		37		99		348	
女性	11		22		40		54		57		32		36		121		373	
男女合計	23		43		91		108		106		57		73		220		721	

全県 (60歳以上・再掲)

	64	割合	69	割合	70	割合	80	割合	90	割合	全体数	割合
1と回答												
男性	64	32.5%	75	30.6%	115	28.9%	58	28.6%	3	16.7%	315	29.7%
女性	81	39.9%	103	40.4%	138	37.5%	55	22.1%	3	5.7%	380	33.7%
男女合計	145	36.3%	178	35.6%	253	33.0%	113	25.0%	6	8.5%	695	31.7%
2と回答												
男性	129	65.5%	163	66.5%	271	68.1%	133	65.5%	13	72.2%	709	66.8%
女性	120	59.1%	145	56.9%	217	59.0%	173	69.5%	41	77.4%	696	61.7%
男女合計	249	62.3%	308	61.6%	488	63.7%	306	67.7%	54	76.1%	1405	64.2%
無回答												
男性	4	2.0%	7	2.9%	12	3.0%	12	5.9%	2	11.1%	37	3.5%
女性	2	1.0%	7	2.7%	13	3.5%	21	8.4%	9	17.0%	52	4.6%
男女合計	6	1.5%	14	2.8%	25	3.3%	33	7.3%	11	15.5%	89	4.1%
全体(人)												
男性	197		245		398		203		18		1061	
女性	203		255		368		249		53		1128	
男女合計	400		500		766		452		71		2189	

17 歯みがきの状況（満15歳以上対象）（調査票 問17）

問17 あなたは毎食後（1日3回以上）歯をみがいていますか。

1 はい 2 いいえ

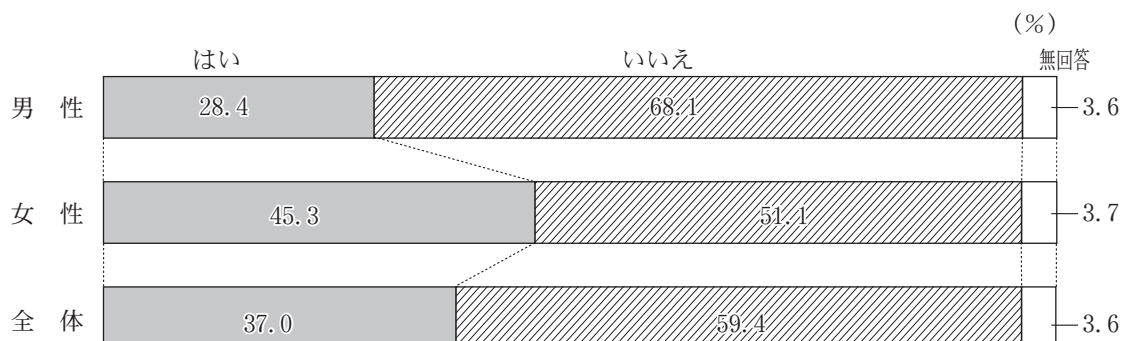

	10	割合	20	割合	30	割合	40	割合	50	割合	64	割合	69	割合	70	割合	80	割合	90	割合	全体数	割合
1と回答																						
男性	16	21.1%	40	33.3%	50	24.3%	62	24.5%	66	24.3%	59	29.9%	74	30.2%	126	31.7%	66	32.5%	5	27.8%	564	28.4%
女性	24	35.3%	61	50.0%	86	49.7%	121	47.3%	148	44.7%	87	42.9%	119	46.7%	179	48.6%	98	39.4%	18	34.0%	941	45.3%
男女合計	40	27.8%	101	41.7%	136	35.9%	183	36.0%	214	35.5%	146	36.5%	193	38.6%	305	39.8%	164	36.3%	23	32.4%	1505	37.0%
2と回答																						
男性	56	73.7%	76	63.3%	149	72.3%	182	71.9%	200	73.5%	134	68.0%	165	67.3%	255	64.1%	125	61.6%	11	61.1%	1353	68.1%
女性	42	61.8%	55	45.1%	85	49.1%	128	50.0%	174	52.6%	113	55.7%	129	50.6%	175	47.6%	131	52.6%	29	54.7%	1061	51.1%
男女合計	98	68.1%	131	54.1%	234	61.7%	310	60.9%	374	62.0%	247	61.8%	294	58.8%	430	56.1%	256	56.6%	40	56.3%	2414	59.4%
無回答																						
男性	4	5.3%	4	3.3%	7	3.4%	9	3.6%	6	2.2%	4	2.0%	6	2.4%	17	4.3%	12	5.9%	2	11.1%	71	3.6%
女性	2	2.9%	6	4.9%	2	1.2%	7	2.7%	9	2.7%	3	1.5%	7	2.7%	14	3.8%	20	8.0%	6	11.3%	76	3.7%
男女合計	6	4.2%	10	4.1%	9	2.4%	16	3.1%	15	2.5%	7	1.8%	13	2.6%	31	4.0%	32	7.1%	8	11.3%	147	3.6%
全体(人)																						
男性	76		120		206		253		272		197		245		398		203		18		1988	
女性	68		122		173		256		331		203		255		368		249		53		2078	
男女合計	144		242		379		509		603		400		500		766		452		71		4066	

県 北

	10	割合	20	割合	30	割合	40	割合	50	割合	64	割合	69	割合	70～	割合	全体数	割合
1と回答																		
男性	7	24.1%	13	34.2%	15	25.9%	24	33.8%	23	29.1%	17	30.4%	28	43.8%	55	32.4%	182	32.2%
女性	10	43.5%	27	60.0%	26	57.8%	36	52.9%	50	50.0%	23	46.0%	31	47.0%	78	43.1%	281	48.6%
男女合計	17	32.7%	40	48.2%	41	39.8%	60	43.2%	73	40.8%	40	37.7%	59	45.4%	133	37.9%	463	40.5%
2と回答																		
男性	20	69.0%	24	63.2%	40	69.0%	43	60.6%	53	67.1%	37	66.1%	34	53.1%	105	61.8%	356	63.0%
女性	12	52.2%	16	35.6%	17	37.8%	29	42.6%	48	48.0%	27	54.0%	31	47.0%	95	52.5%	275	47.6%
男女合計	32	61.5%	40	48.2%	57	55.3%	72	51.8%	101	56.4%	64	60.4%	65	50.0%	200	57.0%	631	55.2%
無回答																		
男性	2	6.9%	1	2.6%	3	5.2%	4	5.6%	3	3.8%	2	3.6%	2	3.1%	10	5.9%	27	4.8%
女性	1	4.3%	2	4.4%	2	4.4%	3	4.4%	2	2.0%	0	0.0%	4	6.1%	8	4.4%	22	3.8%
男女合計	3	5.8%	3	3.6%	5	4.9%	7	5.0%	5	2.8%	2	1.9%	6	4.6%	18	5.1%	49	4.3%
全体(人)																		
男性	29		38		58		71		79		56		64		170		565	
女性	23		45		45		68		100		50		66		181		578	
男女合計	52		83		103		139		179		106		130		351		1143	

県 中

	10	割合	20	割合	30	割合	40	割合	50	割合	64	割合	69	割合	70～	割合	全体数	割合
1と回答																		
男性	2	12.5%	9	37.5%	16	29.6%	15	21.1%	16	23.5%	10	22.7%	17	29.8%	32	29.1%	117	26.4%
女性	4	19.0%	13	40.6%	28	59.6%	35	50.0%	32	37.6%	20	42.6%	29	43.9%	40	37.7%	201	42.4%
男女合計	6	16.2%	22	39.3%	44	43.6%	50	35.5%	48	31.4%	30	33.0%	46	37.4%	72	33.3%	318	34.6%
2と回答																		
男性	13	81.3%	14	58.3%	37	68.5%	56	78.9%	51	75.0%	33	75.0%	38	66.7%	72	65.5%	314	70.7%
女性	16	76.2%	18	56.3%	19	40.4%	35	50.0%	51	60.0%	26	55.3%	35	53.0%	56	52.8%	256	54.0%
男女合計	29	78.4%	32	57.1%	56	55.4%	91	64.5%	102	66.7%	59	64.8%	73	59.3%	128	59.3%	570	62.1%
無回答																		
男性	1	6.3%	1	4.2%	1	1.9%	0	0.0%	1	1.5%	1	2.3%	2	3.5%	6	5.5%	13	2.9%
女性	1	4.8%	1	3.1%	0	0.0%	0	0.0%	2	2.4%	1	2.1%	2	3.0%	10	9.4%	17	3.6%
男女合計	2	5.4%	2	3.6%	1	1.0%	0	0.0%	3	2.0%	2	2.2%	4	3.3%	16	7.4%	30	3.3%
全体(人)																		
男性	16		24		54		71		68		44		57		110		444	
女性	21		32		47		70		85		47		66		106		474	
男女合計	37		56		101		141		153		91		123		216		918	

県 南

	10	割合	20	割合	30	割合	40	割合	50	割合	64	割合	69	割合	70～	割合	全体数	割合
1と回答																		
男性	0	0.0%	6	46.2%	1	8.3%	4	19.0%	8	27.6%	8	38.1%	5	20.0%	21	33.9%	53	28.8%
女性	1	25.0%	2	50.0%	6	60.0%	10	47.6%	13	46.4%	11	44.0%	14	53.8%	33	47.8%	90	48.1%
男女合計	1	20.0%	8	47.1%	7	31.8%	14	33.3%	21	36.8%	19	41.3%	19	37.3%	54	41.2%	143	38.5%
2と回答																		
男性	1	100.0%	7	53.8%	11	91.7%	17	81.0%	21	72.4%	13	61.9%	20	80.0%	40	64.5%	130	70.7%
女性	3	75.0%	2	50.0%	4	40.0%	11	52.4%	14	50.0%	14	56.0%	12	46.2%	31	44.9%	91	48.7%
男女合計	4	80.0%	9	52.9%	15	68.2%	28	66.7%	35	61.4%	27	58.7%	32	62.7%	71	54.2%	221	59.6%
無回答																		
男性	0	0.0%	0	0.0%	0	0.0%	0	0.0%	0	0.0%	0	0.0%	0	0.0%	1	1.6%	1	0.5%
女性	0	0.0%	0	0.0%	0	0.0%	0	0.0%	1	3.6%	0	0.0%	0	0.0%	5	7.2%	6	3.2%
男女合計	0	0.0%	0	0.0%	0	0.0%	0	0.0%	1	1.8%	0	0.0%	0	0.0%	6	4.6%	7	1.9%
全体(人)																		
男性	1		13		12		21		29		21		25		62		184	
女性	4		4		10		21		28		25		26		69		187	
男女合計	5		17		22		42		57		46		51		131		371	

会 津

	10	割合	20	割合	30	割合	40	割合	50	割合	64	割合	69	割合	70～	割合	全体数	割合
1と回答																		
男性	3	25.0%	4	30.8%	3	15.0%	8	32.0%	10	31.3%	7	20.0%	6	18.2%	42	35.3%	83	28.7%
女性	3	60.0%	9	64.3%	9	40.9%	10	37.0%	19	51.4%	14	43.8%	14	43.8%	61	46.9%	139	46.5%
男女合計	6	35.3%	13	48.1%	12	28.6%	18	34.6%	29	42.0%	21	31.3%	20	30.8%	103	41.4%	222	37.8%
2と回答																		
男性	8	66.7%	9	69.2%	15	75.0%	15	60.0%	21	65.6%	27	77.1%	26	78.8%	70	58.8%	191	66.1%
女性	2	40.0%	4	28.6%	13	59.1%	16	59.3%	16	43.2%	17	53.1%	18	56.3%	60	46.2%	146	48.8%
男女合計	10	58.8%	13	48.1%	28	66.7%	31	59.6%	37	53.6%	44	65.7%	44	67.7%	130	52.2%	337	57.3%
無回答																		
男性	1	8.3%	0	0.0%	2	10.0%	2	8.0%	1	3.1%	1	2.9%	1	3.0%	7	5.9%	15	5.2%
女性	0	0.0%	1	7.1%	0	0.0%	1	3.7%	2	5.4%	1	3.1%	0	0.0%	9	6.9%	14	4.7%
男女合計	1	5.9%	1	3.7%	2	4.8%	3	5.8%	3	4.3%	2	3.0%	1	1.5%	16	6.4%	29	4.9%
全体(人)																		
男性	12		13		20		25		32		35		33		119		289	
女性	5		14		22		27		37		32		32		130		299	
男女合計	17		27		42		52		69		67		65		249		588	

南会津

	10	割合	20	割合	30	割合	40	割合	50	割合	64	割合	69	割合	70～	割合	全体数	割合
1と回答																		
男性	1	50.0%	0	0.0%	1	100.0%	1	33.3%	2	66.7%	2	66.7%	1	25.0%	6	30.0%	14	36.8%
女性	2	66.7%	0	0.0%	0	0.0%	4	80.0%	2	66.7%	0	0.0%	2	33.3%	6	40.0%	16	45.7%
男女合計	3	60.0%	0	0.0%	1	50.0%	5	62.5%	4	66.7%	2	40.0%	3	30.0%	12	34.3%	30	41.1%
2と回答																		
男性	1	50.0%	2	100.0%	0	0.0%	2	66.7%	1	33.3%	1	33.3%	3	75.0%	13	65.0%	23	60.5%
女性	1	33.3%	0	0.0%	1	100.0%	1	20.0%	0	0.0%	2	100.0%	4	66.7%	6	40.0%	15	42.9%
男女合計	2	40.0%	2	100.0%	1	50.0%	3	37.5%	1	16.7%	3	60.0%	7	70.0%	19	54.3%	38	52.1%
無回答																		
男性	0	0.0%	0	0.0%	0	0.0%	0	0.0%	0	0.0%	0	0.0%	0	0.0%	1	5.0%	1	2.6%
女性	0	0.0%	0	0.0%	0	0.0%	0	0.0%	1	33.3%	0	0.0%	0	0.0%	3	20.0%	4	11.4%
男女合計	0	0.0%	0	0.0%	0	0.0%	0	0.0%	1	16.7%	0	0.0%	0	0.0%	4	11.4%	5	6.8%
全体(人)																		
男性	2		2		1		3		3		3		4		20		38	
女性	3		0		1		5		3		2		6		15		35	
男女合計	5		2		2		8		6		5		10		35		73	

相 双

	10	割合	20	割合	30	割合	40	割合	50	割合	64	割合	69	割合	70～	割合	全体数	割合
1と回答																		
男性	1	25.0%	1	11.1%	3	30.0%	1	12.5%	1	8.3%	6	46.2%	11	44.0%	15	38.5%	39	32.5%
女性	0	0.0%	2	40.0%	3	37.5%	5	45.5%	6	28.6%	5	33.3%	13	56.5%	22	45.8%	56	42.4%
男女合計	1	20.0%	3	21.4%	6	33.3%	6	31.6%	7	21.2%	11	39.3%	24	50.0%	37	42.5%	95	37.7%
2と回答																		
男性	3	75.0%	8	88.9%	7	70.0%	5	62.5%	11	91.7%	7	53.8%	13	52.0%	23	59.0%	77	64.2%
女性	1	100.0%	3	60.0%	5	62.5%	5	45.5%	15	71.4%	9	60.0%	10	43.5%	25	52.1%	73	55.3%
男女合計	4	80.0%	11	78.6%	12	66.7%	10	52.6%	26	78.8%	16	57.1%	23	47.9%	48	55.2%	150	59.5%
無回答																		
男性	0	0.0%	0	0.0%	0	0.0%	2	25.0%	0	0.0%	0	0.0%	1	4.0%	1	2.6%	4	3.3%
女性	0	0.0%	0	0.0%	0	0.0%	1	9.1%	0	0.0%	1	6.7%	0	0.0%	1	2.1%	3	2.3%
男女合計	0	0.0%	0	0.0%	0	0.0%	3	15.8%	0	0.0%	1	3.6%	1	2.1%	2	2.3%	7	2.8%
全体(人)																		
男性	4		9		10		8		12		13		25		39		120	
女性	1		5		8		11		21		15		23		48		132	
男女合計	5		14		18		19		33		28		48		87		252	

いわき

	10	割合	20	割合	30	割合	40	割合	50	割合	64	割合	69	割合	70～	割合	全体数	割合
1と回答																		
男性	2	16.7%	7	33.3%	11	21.6%	9	16.7%	6	12.2%	9	36.0%	6	16.2%	26	26.3%	76	21.8%
女性	4	36.4%	8	36.4%	14	35.0%	21	38.9%	26	45.6%	14	43.8%	16	44.4%	55	45.5%	158	42.4%
男女合計	6	26.1%	15	34.9%	25	27.5%	30	27.8%	32	30.2%	23	40.4%	22	30.1%	81	36.8%	234	32.5%
2と回答																		
男性	10	83.3%	12	57.1%	39	76.5%	44	81.5%	42	85.7%	16	64.0%	31	83.8%	68	68.7%	262	75.3%
女性	7	63.6%	12	54.5%	26	65.0%	31	57.4%	30	52.6%	18	56.3%	19	52.8%	62	51.2%	205	55.0%
男女合計	17	73.9%	24	55.8%	65	71.4%	75	69.4%	72	67.9%	34	59.6%	50	68.5%	130	59.1%	467	64.8%
無回答																		
男性	0	0.0%	2	9.5%	1	2.0%	1	1.9%	1	2.0%	0	0.0%	0	0.0%	5	5.1%	10	2.9%
女性	0	0.0%	2	9.1%	0	0.0%	2	3.7%	1	1.8%	0	0.0%	1	2.8%	4	3.3%	10	2.7%
男女合計	0	0.0%	4	9.3%	1	1.1%	3	2.8%	2	1.9%	0	0.0%	1	1.4%	9	4.1%	20	2.8%
全体(人)																		
男性	12		21		51		54		49		25		37		99		348	
女性	11		22		40		54		57		32		36		121		373	
男女合計	23		43		91		108		106		57		73		220		721	

全県(60歳以上・再掲)

	64	割合	69	割合	70	割合	80	割合	90	割合	全体数	割合
1と回答												
男性	59	29.9%	74	30.2%	126	31.7%	66	32.5%	5	27.8%	330	31.1%
女性	87	42.9%	119	46.7%	179	48.6%	98	39.4%	18	34.0%	501	44.4%
男女合計	146	36.5%	193	38.6%	305	39.8%	164	36.3%	23	32.4%	831	38.0%
2と回答												
男性	134	68.0%	165	67.3%	255	64.1%	125	61.6%	11	61.1%	690	65.0%
女性	113	55.7%	129	50.6%	175	47.6%	131	52.6%	29	54.7%	577	51.2%
男女合計	247	61.8%	294	58.8%	430	56.1%	256	56.6%	40	56.3%	1267	57.9%
無回答												
男性	4	2.0%	6	2.4%	17	4.3%	12	5.9%	2	11.1%	41	3.9%
女性	3	1.5%	7	2.7%	14	3.8%	20	8.0%	6	11.3%	50	4.4%
男女合計	7	1.8%	13	2.6%	31	4.0%	32	7.1%	8	11.3%	91	4.2%
全体(人)												
男性	197		245		398		203		18		1061	
女性	203		255		368		249		53		1128	
男女合計	400		500		766		452		71		2189	

18 外出の状況（満15歳以上対象）（調査票 問18）

問18 あなたは積極的に外出するほうですか。
（外出には日常生活の中での買物や散歩を含めます）

1 はい 2 いいえ

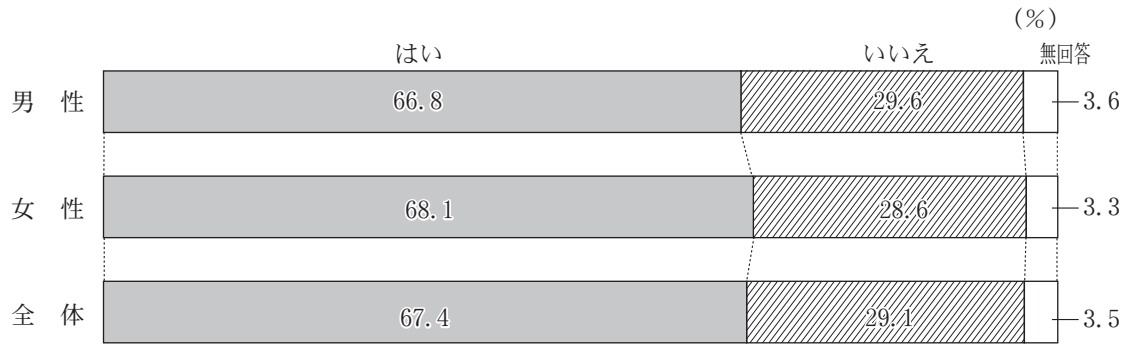

	10	割合	20	割合	30	割合	40	割合	50	割合	64	割合	69	割合	70	割合	80	割合	90	割合	全体数	割合
1と回答																						
男性	42	55.3%	80	66.7%	141	68.4%	149	58.9%	192	70.6%	139	70.6%	173	70.6%	276	69.3%	127	62.6%	8	44.4%	1327	66.8%
女性	41	60.3%	78	63.9%	126	72.8%	196	76.6%	232	70.1%	151	74.4%	196	76.9%	275	74.7%	114	45.8%	6	11.3%	1415	68.1%
男女合計	83	57.6%	158	65.3%	267	70.4%	345	67.8%	424	70.3%	290	72.5%	369	73.8%	551	71.9%	241	53.3%	14	19.7%	2742	67.4%
2と回答																						
男性	29	38.2%	36	30.0%	60	29.1%	96	37.9%	74	27.2%	52	26.4%	64	26.1%	106	26.6%	64	31.5%	8	44.4%	589	29.6%
女性	26	38.2%	39	32.0%	45	26.0%	52	20.3%	88	26.6%	50	24.6%	51	20.0%	82	22.3%	120	48.2%	41	77.4%	594	28.6%
男女合計	55	38.2%	75	31.0%	105	27.7%	148	29.1%	162	26.9%	102	25.5%	115	23.0%	188	24.5%	184	40.7%	49	69.0%	1183	29.1%
無回答																						
男性	5	6.6%	4	3.3%	5	2.4%	8	3.2%	6	2.2%	6	3.0%	8	3.3%	16	4.0%	12	5.9%	2	11.1%	72	3.6%
女性	1	1.5%	5	4.1%	2	1.2%	8	3.1%	11	3.3%	2	1.0%	8	3.1%	11	3.0%	15	6.0%	6	11.3%	69	3.3%
男女合計	6	4.2%	9	3.7%	7	1.8%	16	3.1%	17	2.8%	8	2.0%	16	3.2%	27	3.5%	27	6.0%	8	11.3%	141	3.5%
全体(人)																						
男性	76	120	206	253	272	197	245	398	203	18											1988	
女性	68	122	173	256	331	203	255	368	249	53											2078	
男女合計	144	242	379	509	603	400	500	766	452	71											4066	

県 北

	10	割合	20	割合	30	割合	40	割合	50	割合	64	割合	69	割合	70～	割合	全体数	割合
1と回答																		
男性	20	69.0%	22	57.9%	40	69.0%	44	62.0%	58	73.4%	40	71.4%	50	78.1%	113	66.5%	387	68.5%
女性	15	65.2%	29	64.4%	32	71.1%	49	72.1%	71	71.0%	39	78.0%	47	71.2%	103	56.9%	385	66.6%
男女合計	35	67.3%	51	61.4%	72	69.9%	93	66.9%	129	72.1%	79	74.5%	97	74.6%	216	61.5%	772	67.5%
2と回答																		
男性	7	24.1%	15	39.5%	16	27.6%	23	32.4%	18	22.8%	14	25.0%	12	18.8%	46	27.1%	151	26.7%
女性	7	30.4%	14	31.1%	11	24.4%	16	23.5%	26	26.0%	11	22.0%	15	22.7%	70	38.7%	170	29.4%
男女合計	14	26.9%	29	34.9%	27	26.2%	39	28.1%	44	24.6%	25	23.6%	27	20.8%	116	33.0%	321	28.1%
無回答																		
男性	2	6.9%	1	2.6%	2	3.4%	4	5.6%	3	3.8%	2	3.6%	2	3.1%	11	6.5%	27	4.8%
女性	1	4.3%	2	4.4%	2	4.4%	3	4.4%	3	3.0%	0	0.0%	4	6.1%	8	4.4%	23	4.0%
男女合計	3	5.8%	3	3.6%	4	3.9%	7	5.0%	6	3.4%	2	1.9%	6	4.6%	19	5.4%	50	4.4%
全体(人)																		
男性	29		38		58		71		79		56		64		170		565	
女性	23		45		45		68		100		50		66		181		578	
男女合計	52		83		103		139		179		106		130		351		1143	

県 中

	10	割合	20	割合	30	割合	40	割合	50	割合	64	割合	69	割合	70～	割合	全体数	割合
1と回答																		
男性	9	56.3%	16	66.7%	39	72.2%	43	60.6%	51	75.0%	32	72.7%	41	71.9%	69	62.7%	300	67.6%
女性	11	52.4%	21	65.6%	34	72.3%	54	77.1%	54	63.5%	33	70.2%	51	77.3%	55	51.9%	313	66.0%
男女合計	20	54.1%	37	66.1%	73	72.3%	97	68.8%	105	68.6%	65	71.4%	92	74.8%	124	57.4%	613	66.8%
2と回答																		
男性	6	37.5%	7	29.2%	15	27.8%	28	39.4%	16	23.5%	10	22.7%	13	22.8%	35	31.8%	130	29.3%
女性	10	47.6%	11	34.4%	13	27.7%	15	21.4%	29	34.1%	13	27.7%	13	19.7%	43	40.6%	147	31.0%
男女合計	16	43.2%	18	32.1%	28	27.7%	43	30.5%	45	29.4%	23	25.3%	26	21.1%	78	36.1%	277	30.2%
無回答																		
男性	1	6.3%	1	4.2%	0	0.0%	0	0.0%	1	1.5%	2	4.5%	3	5.3%	6	5.5%	14	3.2%
女性	0	0.0%	0	0.0%	0	0.0%	1	1.4%	2	2.4%	1	2.1%	2	3.0%	8	7.5%	14	3.0%
男女合計	1	2.7%	1	1.8%	0	0.0%	1	0.7%	3	2.0%	3	3.3%	5	4.1%	14	6.5%	28	3.1%
全体(人)																		
男性	16		24		54		71		68		44		57		110		444	
女性	21		32		47		70		85		47		66		106		474	
男女合計	37		56		101		141		153		91		123		216		918	

県 南

	10	割合	20	割合	30	割合	40	割合	50	割合	64	割合	69	割合	70～	割合	全体数	割合
1と回答																		
男性	1	100.0%	8	61.5%	8	66.7%	9	42.9%	18	62.1%	18	85.7%	18	72.0%	42	67.7%	122	66.3%
女性	1	25.0%	3	75.0%	7	70.0%	18	85.7%	22	78.6%	20	80.0%	20	76.9%	46	66.7%	137	73.3%
男女合計	2	40.0%	11	64.7%	15	68.2%	27	64.3%	40	70.2%	38	82.6%	38	74.5%	88	67.2%	259	69.8%
2と回答																		
男性	0	0.0%	5	38.5%	4	33.3%	12	57.1%	11	37.9%	3	14.3%	7	28.0%	20	32.3%	62	33.7%
女性	3	75.0%	1	25.0%	3	30.0%	3	14.3%	5	17.9%	5	20.0%	6	23.1%	19	27.5%	45	24.1%
男女合計	3	60.0%	6	35.3%	7	31.8%	15	35.7%	16	28.1%	8	17.4%	13	25.5%	39	29.8%	107	28.8%
無回答																		
男性	0	0.0%	0	0.0%	0	0.0%	0	0.0%	0	0.0%	0	0.0%	0	0.0%	0	0.0%	0	0.0%
女性	0	0.0%	0	0.0%	0	0.0%	0	0.0%	1	3.6%	0	0.0%	0	0.0%	4	5.8%	5	2.7%
男女合計	0	0.0%	0	0.0%	0	0.0%	0	0.0%	1	1.8%	0	0.0%	0	0.0%	4	3.1%	5	1.3%
全体(人)																		
男性	1		13		12		21		29		21		25		62		184	
女性	4		4		10		21		28		25		26		69		187	
男女合計	5		17		22		42		57		46		51		131		371	

会 津

	10	割合	20	割合	30	割合	40	割合	50	割合	64	割合	69	割合	70～	割合	全体数	割合
1と回答																		
男性	3	25.0%	11	84.6%	13	65.0%	16	64.0%	18	56.3%	19	54.3%	21	63.6%	86	72.3%	187	64.7%
女性	3	60.0%	11	78.6%	15	68.2%	21	77.8%	28	75.7%	24	75.0%	24	75.0%	75	57.7%	201	67.2%
男女合計	6	35.3%	22	81.5%	28	66.7%	37	71.2%	46	66.7%	43	64.2%	45	69.2%	161	64.7%	388	66.0%
2と回答																		
男性	7	58.3%	2	15.4%	5	25.0%	8	32.0%	13	40.6%	15	42.9%	10	30.3%	26	21.8%	86	29.8%
女性	2	40.0%	2	14.3%	7	31.8%	5	18.5%	7	18.9%	7	21.9%	7	21.9%	50	38.5%	87	29.1%
男女合計	9	52.9%	4	14.8%	12	28.6%	13	25.0%	20	29.0%	22	32.8%	17	26.2%	76	30.5%	173	29.4%
無回答																		
男性	2	16.7%	0	0.0%	2	10.0%	1	4.0%	1	3.1%	1	2.9%	2	6.1%	7	5.9%	16	5.5%
女性	0	0.0%	1	7.1%	0	0.0%	1	3.7%	2	5.4%	1	3.1%	1	3.1%	5	3.8%	11	3.7%
男女合計	2	11.8%	1	3.7%	2	4.8%	2	3.8%	3	4.3%	2	3.0%	3	4.6%	12	4.8%	27	4.6%
全体(人)																		
男性	12		13		20		25		32		35		33		119		289	
女性	5		14		22		27		37		32		32		130		299	
男女合計	17		27		42		52		69		67		65		249		588	

南会津

	10	割合	20	割合	30	割合	40	割合	50	割合	64	割合	69	割合	70～	割合	全体数	割合
1と回答																		
男性	0	0.0%	1	50.0%	1	100.0%	2	66.7%	3	100.0%	3	100.0%	3	75.0%	13	65.0%	26	68.4%
女性	2	66.7%	0	0.0%	0	0.0%	5	100.0%	1	33.3%	1	50.0%	5	83.3%	8	53.3%	22	62.9%
男女合計	2	40.0%	1	50.0%	1	50.0%	7	87.5%	4	66.7%	4	80.0%	8	80.0%	21	60.0%	48	65.8%
2と回答																		
男性	2	100.0%	1	50.0%	0	0.0%	1	33.3%	0	0.0%	0	0.0%	1	25.0%	6	30.0%	11	28.9%
女性	1	33.3%	0	0.0%	1	100.0%	0	0.0%	1	33.3%	1	50.0%	1	16.7%	5	33.3%	10	28.6%
男女合計	3	60.0%	1	50.0%	1	50.0%	1	12.5%	1	16.7%	1	20.0%	2	20.0%	11	31.4%	21	28.8%
無回答																		
男性	0	0.0%	0	0.0%	0	0.0%	0	0.0%	0	0.0%	0	0.0%	0	0.0%	1	5.0%	1	2.6%
女性	0	0.0%	0	0.0%	0	0.0%	0	0.0%	1	33.3%	0	0.0%	0	0.0%	2	13.3%	3	8.6%
男女合計	0	0.0%	0	0.0%	0	0.0%	0	0.0%	1	16.7%	0	0.0%	0	0.0%	3	8.6%	4	5.5%
全体(人)																		
男性	2		2		1		3		3		3		4		20		38	
女性	3		0		1		5		3		2		6		15		35	
男女合計	5		2		2		8		6		5		10		35		73	

相 双

	10	割合	20	割合	30	割合	40	割合	50	割合	64	割合	69	割合	70～	割合	全体数	割合
1と回答																		
男性	3	75.0%	7	77.8%	5	50.0%	5	62.5%	8	66.7%	13	100.0%	15	60.0%	26	66.7%	82	68.3%
女性	1	100.0%	2	40.0%	6	75.0%	6	54.5%	13	61.9%	11	73.3%	20	87.0%	34	70.8%	93	70.5%
男女合計	4	80.0%	9	64.3%	11	61.1%	11	57.9%	21	63.6%	24	85.7%	35	72.9%	60	69.0%	175	69.4%
2と回答																		
男性	1	25.0%	2	22.2%	5	50.0%	1	12.5%	4	33.3%	0	0.0%	9	36.0%	12	30.8%	34	28.3%
女性	0	0.0%	3	60.0%	2	25.0%	4	36.4%	8	38.1%	4	26.7%	3	13.0%	13	27.1%	37	28.0%
男女合計	1	20.0%	5	35.7%	7	38.9%	5	26.3%	12	36.4%	4	14.3%	12	25.0%	25	28.7%	71	28.2%
無回答																		
男性	0	0.0%	0	0.0%	0	0.0%	2	25.0%	0	0.0%	0	0.0%	1	4.0%	1	2.6%	4	3.3%
女性	0	0.0%	0	0.0%	0	0.0%	1	9.1%	0	0.0%	0	0.0%	0	0.0%	1	2.1%	2	1.5%
男女合計	0	0.0%	0	0.0%	0	0.0%	3	15.8%	0	0.0%	0	0.0%	1	2.1%	2	2.3%	6	2.4%
全体(人)																		
男性	4		9		10		8		12		13		25		39		120	
女性	1		5		8		11		21		15		23		48		132	
男女合計	5		14		18		19		33		28		48		87		252	

いわき

	10	割合	20	割合	30	割合	40	割合	50	割合	64	割合	69	割合	70～	割合	全体数	割合
1と回答																		
男性	6	50.0%	15	71.4%	35	68.6%	30	55.6%	36	73.5%	14	56.0%	25	67.6%	62	62.6%	223	64.1%
女性	8	72.7%	12	54.5%	32	80.0%	43	79.6%	43	75.4%	23	71.9%	29	80.6%	74	61.2%	264	70.8%
男女合計	14	60.9%	27	62.8%	67	73.6%	73	67.6%	79	74.5%	37	64.9%	54	74.0%	136	61.8%	487	67.5%
2と回答																		
男性	6	50.0%	4	19.0%	15	29.4%	23	42.6%	12	24.5%	10	40.0%	12	32.4%	33	33.3%	115	33.0%
女性	3	27.3%	8	36.4%	8	20.0%	9	16.7%	12	21.1%	9	28.1%	6	16.7%	43	35.5%	98	26.3%
男女合計	9	39.1%	12	27.9%	23	25.3%	32	29.6%	24	22.6%	19	33.3%	18	24.7%	76	34.5%	213	29.5%
無回答																		
男性	0	0.0%	2	9.5%	1	2.0%	1	1.9%	1	2.0%	1	4.0%	0	0.0%	4	4.0%	10	2.9%
女性	0	0.0%	2	9.1%	0	0.0%	2	3.7%	2	3.5%	0	0.0%	1	2.8%	4	3.3%	11	2.9%
男女合計	0	0.0%	4	9.3%	1	1.1%	3	2.8%	3	2.8%	1	1.8%	1	1.4%	8	3.6%	21	2.9%
全体(人)																		
男性	12		21		51		54		49		25		37		99		348	
女性	11		22		40		54		57		32		36		121		373	
男女合計	23		43		91		108		106		57		73		220		721	

全県 (60歳以上・再掲)

	64	割合	69	割合	70	割合	80	割合	90	割合	全体数	割合
1と回答												
男性	139	70.6%	173	70.6%	276	69.3%	127	62.6%	8	44.4%	723	68.1%
女性	151	74.4%	196	76.9%	275	74.7%	114	45.8%	6	11.3%	742	65.8%
男女合計	290	72.5%	369	73.8%	551	71.9%	241	53.3%	14	19.7%	1465	66.9%
2と回答												
男性	52	26.4%	64	26.1%	106	26.6%	64	31.5%	8	44.4%	294	27.7%
女性	50	24.6%	51	20.0%	82	22.3%	120	48.2%	41	77.4%	344	30.5%
男女合計	102	25.5%	115	23.0%	188	24.5%	184	40.7%	49	69.0%	638	29.1%
無回答												
男性	6	3.0%	8	3.3%	16	4.0%	12	5.9%	2	11.1%	44	4.1%
女性	2	1.0%	8	3.1%	11	3.0%	15	6.0%	6	11.3%	42	3.7%
男女合計	8	2.0%	16	3.2%	27	3.5%	27	6.0%	8	11.3%	86	3.9%
全体(人)												
男性	197		245		398		203		18		1061	
女性	203		255		368		249		53		1128	
男女合計	400		500		766		452		71		2189	

19 地域活動の実施状況（満15歳以上対象）（調査票 問19）

問19 あなたは何らかの地域活動を実施していますか。あてはまる番号に○をつけてください。（○はいくつでも）

- 1 老人クラブ
- 2 健康・スポーツの集まりや団体
- 3 趣味の集まりや団体
- 4 社会奉仕団体（ボランティア団体）
- 5 町内会、自治会の活動
- 6 宗教団体
- 7 職場のクラブ活動など
- 8 その他
- 9 何も参加していない

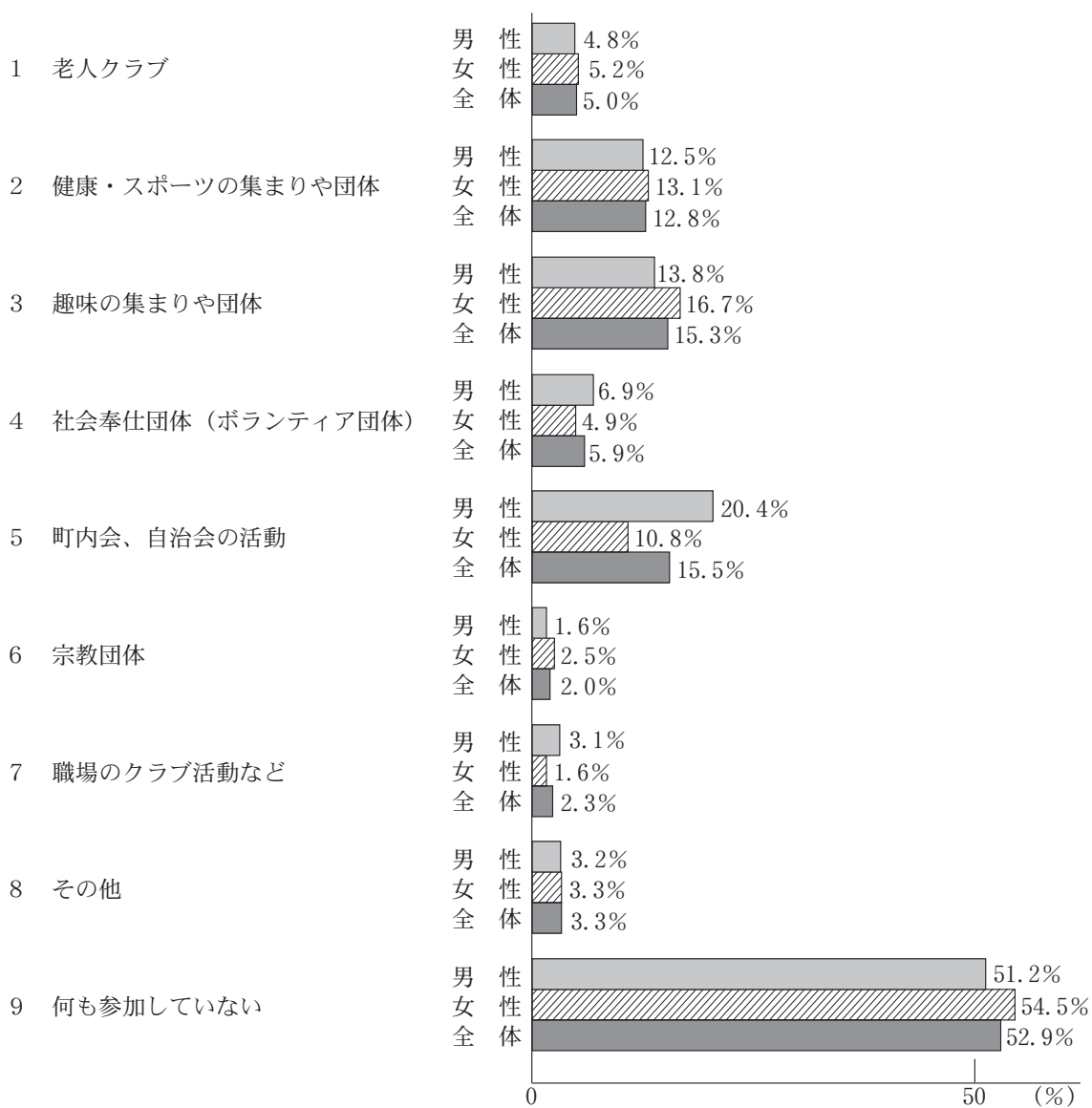

1. 老人クラブと回答した人

	10	割合	20	割合	30	割合	40	割合	50	割合	64	割合	69	割合	70	割合	80	割合	90	割合	全体数	割合
1に○																						
男性	0	0.0%	0	0.0%	0	0.0%	0	0.0%	1	0.4%	1	0.5%	9	3.7%	47	11.8%	34	16.7%	4	22.2%	96	4.8%
女性	0	0.0%	0	0.0%	0	0.0%	0	0.0%	0	0.0%	1	0.5%	6	2.4%	47	12.8%	48	19.3%	6	11.3%	108	5.2%
男女合計	0	0.0%	0	0.0%	0	0.0%	0	0.0%	1	0.2%	2	0.5%	15	3.0%	94	12.3%	82	18.1%	10	14.1%	204	5.0%
全体(人)																						
男性	76		120		206		253		272		197		245		398		203		18		1988	
女性	68		122		173		256		331		203		255		368		249		53		2078	
男女合計	144		242		379		509		603		400		500		766		452		71		4066	

2. 健康・スポーツの集まりや団体と回答した人

	10	割合	20	割合	30	割合	40	割合	50	割合	64	割合	69	割合	70	割合	80	割合	90	割合	全体数	割合
2に○																						
男性	8	10.5%	16	13.3%	21	10.2%	22	8.7%	25	9.2%	32	16.2%	35	14.3%	60	15.1%	28	13.8%	2	11.1%	249	12.5%
女性	2	2.9%	8	6.6%	10	5.8%	17	6.6%	34	10.3%	26	12.8%	53	20.8%	87	23.6%	33	13.3%	2	3.8%	272	13.1%
男女合計	10	6.9%	24	9.9%	31	8.2%	39	7.7%	59	9.8%	58	14.5%	88	17.6%	147	19.2%	61	13.5%	4	5.6%	521	12.8%
全体(人)																						
男性	76		120		206		253		272		197		245		398		203		18		1988	
女性	68		122		173		256		331		203		255		368		249		53		2078	
男女合計	144		242		379		509		603		400		500		766		452		71		4066	

3. 趣味の集まりや団体と回答した人

	10	割合	20	割合	30	割合	40	割合	50	割合	64	割合	69	割合	70	割合	80	割合	90	割合	全体数	割合
3に○																						
男性	4	5.3%	11	9.2%	22	10.7%	19	7.5%	27	9.9%	19	9.6%	40	16.3%	92	23.1%	38	18.7%	2	11.1%	274	13.8%
女性	4	5.9%	5	4.1%	9	5.2%	22	8.6%	36	10.9%	47	23.2%	67	26.3%	110	29.9%	45	18.1%	3	5.7%	348	16.7%
男女合計	8	5.6%	16	6.6%	31	8.2%	41	8.1%	63	10.4%	66	16.5%	107	21.4%	202	26.4%	83	18.4%	5	7.0%	622	15.3%
全体(人)																						
男性	76		120		206		253		272		197		245		398		203		18		1988	
女性	68		122		173		256		331		203		255		368		249		53		2078	
男女合計	144		242		379		509		603		400		500		766		452		71		4066	

4. 社会奉仕団体（ボランティア団体）と回答した人

	10	割合	20	割合	30	割合	40	割合	50	割合	64	割合	69	割合	70	割合	80	割合	90	割合	全体数	割合
4に○																						
男性	1	1.3%	4	3.3%	9	4.4%	12	4.7%	14	5.1%	14	7.1%	23	9.4%	44	11.1%	16	7.9%	0	0.0%	137	6.9%
女性	1	1.5%	1	0.8%	6	3.5%	5	2.0%	12	3.6%	9	4.4%	21	8.2%	36	9.8%	10	4.0%	0	0.0%	101	4.9%
男女合計	2	1.4%	5	2.1%	15	4.0%	17	3.3%	26	4.3%	23	5.8%	44	8.8%	80	10.4%	26	5.8%	0	0.0%	238	5.9%
全体(人)																						
男性	76		120		206		253		272		197		245		398		203		18		1988	
女性	68		122		173		256		331		203		255		368		249		53		2078	
男女合計	144		242		379		509		603		400		500		766		452		71		4066	

5. 町内会、自治会の活動と回答した人

	10	割合	20	割合	30	割合	40	割合	50	割合	64	割合	69	割合	70	割合	80	割合	90	割合	全体数	割合
5に○																						
男性	2	2.6%	7	5.8%	28	13.6%	40	15.8%	61	22.4%	72	36.5%	68	27.8%	98	24.6%	30	14.8%	0	0.0%	406	20.4%
女性	1	1.5%	4	3.3%	21	12.1%	26	10.2%	42	12.7%	34	16.7%	31	12.2%	48	13.0%	17	6.8%	1	1.9%	225	10.8%
男女合計	3	2.1%	11	4.5%	49	12.9%	66	13.0%	103	17.1%	106	26.5%	99	19.8%	146	19.1%	47	10.4%	1	1.4%	631	15.5%
全体(人)																						
男性	76		120		206		253		272		197		245		398		203		18		1988	
女性	68		122		173		256		331		203		255		368		249		53		2078	
男女合計	144		242		379		509		603		400		500		766		452		71		4066	

6. 宗教団体と回答した人

	10	割合	20	割合	30	割合	40	割合	50	割合	64	割合	69	割合	70	割合	80	割合	90	割合	全体数	割合
6に○																						
男性	0	0.0%	0	0.0%	0	0.0%	2	0.8%	2	0.7%	3	1.5%	6	2.4%	12	3.0%	7	3.4%	0	0.0%	32	1.6%
女性	1	1.5%	0	0.0%	1	0.6%	2	0.8%	11	3.3%	5	2.5%	9	3.5%	13	3.5%	9	3.6%	0	0.0%	51	2.5%
男女合計	1	0.7%	0	0.0%	1	0.3%	4	0.8%	13	2.2%	8	2.0%	15	3.0%	25	3.3%	16	3.5%	0	0.0%	83	2.0%
全体(人)																						
男性	76		120		206		253		272		197		245		398		203		18		1988	
女性	68		122		173		256		331		203		255		368		249		53		2078	
男女合計	144		242		379		509		603		400		500		766		452		71		4066	

7. 職場のクラブ活動などと回答した人

	10	割合	20	割合	30	割合	40	割合	50	割合	64	割合	69	割合	70	割合	80	割合	90	割合	全体数	割合
7に○																						
男性	4	5.3%	7	5.8%	14	6.8%	12	4.7%	13	4.8%	4	2.0%	2	0.8%	3	0.8%	2	1.0%	0	0.0%	61	3.1%
女性	3	4.4%	7	5.7%	6	3.5%	8	3.1%	3	0.9%	1	0.5%	1	0.4%	3	0.8%	1	0.4%	0	0.0%	33	1.6%
男女合計	7	4.9%	14	5.8%	20	5.3%	20	3.9%	16	2.7%	5	1.3%	3	0.6%	6	0.8%	3	0.7%	0	0.0%	94	2.3%
全体(人)																						
男性	76		120		206		253		272		197		245		398		203		18		1988	
女性	68		122		173		256		331		203		255		368		249		53		2078	
男女合計	144		242		379		509		603		400		500		766		452		71		4066	

8. その他と回答した人

	10	割合	20	割合	30	割合	40	割合	50	割合	64	割合	69	割合	70	割合	80	割合	90	割合	全体数	割合
8に○																						
男性	2	2.6%	1	0.8%	9	4.4%	7	2.8%	6	2.2%	4	2.0%	7	2.9%	20	5.0%	7	3.4%	1	5.6%	64	3.2%
女性	2	2.9%	2	1.6%	8	4.6%	5	2.0%	5	1.5%	2	1.0%	9	3.5%	20	5.4%	13	5.2%	3	5.7%	69	3.3%
男女合計	4	2.8%	3	1.2%	17	4.5%	12	2.4%	11	1.8%	6	1.5%	16	3.2%	40	5.2%	20	4.4%	4	5.6%	133	3.3%
全体(人)																						
男性	76		120		206		253		272		197		245		398		203		18		1988	
女性	68		122		173		256		331		203		255		368		249		53		2078	
男女合計	144		242		379		509		603		400		500		766		452		71		4066	

9. 何も参加していないと回答した人

	10	割合	20	割合	30	割合	40	割合	50	割合	64	割合	69	割合	70	割合	80	割合	90	割合	全体数	割合
9に○																						
男性	46	60.5%	75	62.5%	125	60.7%	158	62.5%	147	54.0%	79	40.1%	128	52.2%	159	39.9%	92	45.3%	9	50.0%	1018	51.2%
女性	54	79.4%	96	78.7%	110	63.6%	171	66.8%	203	61.3%	99	48.8%	111	43.5%	135	36.7%	117	47.0%	36	67.9%	1132	54.5%
男女合計	100	69.4%	171	70.7%	235	62.0%	329	64.6%	350	58.0%	178	44.5%	239	47.8%	294	38.4%	209	46.2%	45	63.4%	2150	52.9%
全体(人)																						
男性	76		120		206		253		272		197		245		398		203		18		1988	
女性	68		122		173		256		331		203		255		368		249		53		2078	
男女合計	144		242		379		509		603		400		500		766		452		71		4066	

20 健診（検診）受診の状況（満15歳以上対象）（調査票 問20）

問20 あなたは過去1年間に、健診等（健康診断、健康診査および人間ドック）を受けたことがありますか。（○は1つ）

1 ある 2 ない

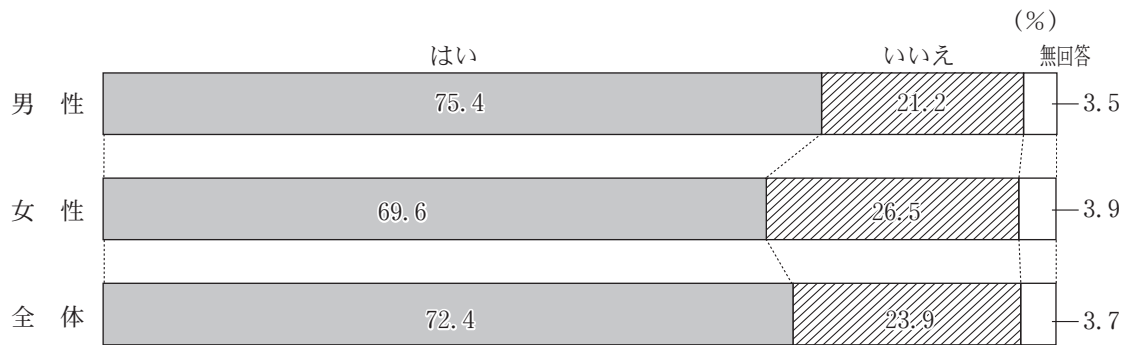

	10	割合	20	割合	30	割合	40	割合	50	割合	64	割合	69	割合	70	割合	80	割合	90	割合	全体数	割合
1と回答																						
男性	46	60.5%	77	64.2%	174	84.5%	221	87.4%	226	83.1%	163	82.7%	185	75.5%	274	68.8%	126	62.1%	6	33.3%	1498	75.4%
女性	36	52.9%	75	61.5%	119	68.8%	197	77.0%	252	76.1%	164	80.8%	175	68.6%	273	74.2%	139	55.8%	16	30.2%	1446	69.6%
男女合計	82	56.9%	152	62.8%	293	77.3%	418	82.1%	478	79.3%	327	81.8%	360	72.0%	547	71.4%	265	58.6%	22	31.0%	2944	72.4%
2と回答																						
男性	26	34.2%	39	32.5%	27	13.1%	24	9.5%	39	14.3%	29	14.7%	53	21.6%	109	27.4%	65	32.0%	10	55.6%	421	21.2%
女性	30	44.1%	42	34.4%	52	30.1%	52	20.3%	70	21.1%	36	17.7%	70	27.5%	79	21.5%	88	35.3%	31	58.5%	550	26.5%
男女合計	56	38.9%	81	33.5%	79	20.8%	76	14.9%	109	18.1%	65	16.3%	123	24.6%	188	24.5%	153	33.8%	41	57.7%	971	23.9%
無回答																						
男性	4	5.3%	4	3.3%	5	2.4%	8	3.2%	7	2.6%	5	2.5%	7	2.9%	15	3.8%	12	5.9%	2	11.1%	69	3.5%
女性	2	2.9%	5	4.1%	2	1.2%	7	2.7%	9	2.7%	3	1.5%	10	3.9%	16	4.3%	22	8.8%	6	11.3%	82	3.9%
男女合計	6	4.2%	9	3.7%	7	1.8%	15	2.9%	16	2.7%	8	2.0%	17	3.4%	31	4.0%	34	7.5%	8	11.3%	151	3.7%
全体(人)																						
男性	76	120	206	253	272	197	245	398	203	18											1988	
女性	68	122	173	256	331	203	255	368	249	53											2078	
男女合計	144	242	379	509	603	400	500	766	452	71											4066	

県 北

	10	割合	20	割合	30	割合	40	割合	50	割合	64	割合	69	割合	70～	割合	全体数	割合
1と回答																		
男性	13	44.8%	21	55.3%	47	81.0%	63	88.7%	68	86.1%	46	82.1%	53	82.8%	115	67.6%	426	75.4%
女性	13	56.5%	26	57.8%	33	73.3%	53	77.9%	75	75.0%	40	80.0%	45	68.2%	116	64.1%	401	69.4%
男女合計	26	50.0%	47	56.6%	80	77.7%	116	83.5%	143	79.9%	86	81.1%	98	75.4%	231	65.8%	827	72.4%
2と回答																		
男性	14	48.3%	16	42.1%	9	15.5%	4	5.6%	8	10.1%	8	14.3%	9	14.1%	47	27.6%	115	20.4%
女性	9	39.1%	17	37.8%	10	22.2%	12	17.6%	23	23.0%	10	20.0%	16	24.2%	53	29.3%	150	26.0%
男女合計	23	44.2%	33	39.8%	19	18.4%	16	11.5%	31	17.3%	18	17.0%	25	19.2%	100	28.5%	265	23.2%
無回答																		
男性	2	6.9%	1	2.6%	2	3.4%	4	5.6%	3	3.8%	2	3.6%	2	3.1%	8	4.7%	24	4.2%
女性	1	4.3%	2	4.4%	2	4.4%	3	4.4%	2	2.0%	0	0.0%	5	7.6%	12	6.6%	27	4.7%
男女合計	3	5.8%	3	3.6%	4	3.9%	7	5.0%	5	2.8%	2	1.9%	7	5.4%	20	5.7%	51	4.5%
全体(人)																		
男性	29		38		58		71		79		56		64		170		565	
女性	23		45		45		68		100		50		66		181		578	
男女合計	52		83		103		139		179		106		130		351		1143	

県 中

	10	割合	20	割合	30	割合	40	割合	50	割合	64	割合	69	割合	70～	割合	全体数	割合
1と回答																		
男性	11	68.8%	16	66.7%	49	90.7%	65	91.5%	59	86.8%	36	81.8%	41	71.9%	64	58.2%	341	76.8%
女性	12	57.1%	19	59.4%	30	63.8%	53	75.7%	65	76.5%	40	85.1%	41	62.1%	59	55.7%	319	67.3%
男女合計	23	62.2%	35	62.5%	79	78.2%	118	83.7%	124	81.0%	76	83.5%	82	66.7%	123	56.9%	660	71.9%
2と回答																		
男性	4	25.0%	7	29.2%	5	9.3%	6	8.5%	7	10.3%	7	15.9%	13	22.8%	38	34.5%	87	19.6%
女性	9	42.9%	13	40.6%	17	36.2%	17	24.3%	18	21.2%	6	12.8%	22	33.3%	36	34.0%	138	29.1%
男女合計	13	35.1%	20	35.7%	22	21.8%	23	16.3%	25	16.3%	13	14.3%	35	28.5%	74	34.3%	225	24.5%
無回答																		
男性	1	6.3%	1	4.2%	0	0.0%	0	0.0%	2	2.9%	1	2.3%	3	5.3%	8	7.3%	16	3.6%
女性	0	0.0%	0	0.0%	0	0.0%	0	0.0%	2	2.4%	1	2.1%	3	4.5%	11	10.4%	17	3.6%
男女合計	1	2.7%	1	1.8%	0	0.0%	0	0.0%	4	2.6%	2	2.2%	6	4.9%	19	8.8%	33	3.6%
全体(人)																		
男性	16		24		54		71		68		44		57		110		444	
女性	21		32		47		70		85		47		66		106		474	
男女合計	37		56		101		141		153		91		123		216		918	

県 南

	10	割合	20	割合	30	割合	40	割合	50	割合	64	割合	69	割合	70～	割合	全体数	割合
1と回答																		
男性	1	100.0%	11	84.6%	11	91.7%	18	85.7%	23	79.3%	17	81.0%	19	76.0%	41	66.1%	141	76.6%
女性	3	75.0%	1	25.0%	8	80.0%	19	90.5%	26	92.9%	22	88.0%	18	69.2%	47	68.1%	144	77.0%
男女合計	4	80.0%	12	70.6%	19	86.4%	37	88.1%	49	86.0%	39	84.8%	37	72.5%	88	67.2%	285	76.8%
2と回答																		
男性	0	0.0%	2	15.4%	1	8.3%	3	14.3%	6	20.7%	4	19.0%	6	24.0%	20	32.3%	42	22.8%
女性	0	0.0%	3	75.0%	2	20.0%	2	9.5%	1	3.6%	3	12.0%	8	30.8%	17	24.6%	36	19.3%
男女合計	0	0.0%	5	29.4%	3	13.6%	5	11.9%	7	12.3%	7	15.2%	14	27.5%	37	28.2%	78	21.0%
無回答																		
男性	0	0.0%	0	0.0%	0	0.0%	0	0.0%	0	0.0%	0	0.0%	0	0.0%	1	1.6%	1	0.5%
女性	1	25.0%	0	0.0%	0	0.0%	0	0.0%	1	3.6%	0	0.0%	0	0.0%	5	7.2%	7	3.7%
男女合計	1	20.0%	0	0.0%	0	0.0%	0	0.0%	1	1.8%	0	0.0%	0	0.0%	6	4.6%	8	2.2%
全体(人)																		
男性	1		13		12		21		29		21		25		62		184	
女性	4		4		10		21		28		25		26		69		187	
男女合計	5		17		22		42		57		46		51		131		371	

会 津

	10	割合	20	割合	30	割合	40	割合	50	割合	64	割合	69	割合	70～	割合	全体数	割合
1と回答																		
男性	7	58.3%	8	61.5%	14	70.0%	19	76.0%	23	71.9%	30	85.7%	24	72.7%	75	63.0%	200	69.2%
女性	2	40.0%	11	78.6%	14	63.6%	23	85.2%	30	81.1%	26	81.3%	25	78.1%	84	64.6%	215	71.9%
男女合計	9	52.9%	19	70.4%	28	66.7%	42	80.8%	53	76.8%	56	83.6%	49	75.4%	159	63.9%	415	70.6%
2と回答																		
男性	4	33.3%	5	38.5%	4	20.0%	5	20.0%	8	25.0%	4	11.4%	8	24.2%	38	31.9%	76	26.3%
女性	3	60.0%	2	14.3%	8	36.4%	3	11.1%	5	13.5%	5	15.6%	7	21.9%	39	30.0%	72	24.1%
男女合計	7	41.2%	7	25.9%	12	28.6%	8	15.4%	13	18.8%	9	13.4%	15	23.1%	77	30.9%	148	25.2%
無回答																		
男性	1	8.3%	0	0.0%	2	10.0%	1	4.0%	1	3.1%	1	2.9%	1	3.0%	6	5.0%	13	4.5%
女性	0	0.0%	1	7.1%	0	0.0%	1	3.7%	2	5.4%	1	3.1%	0	0.0%	7	5.4%	12	4.0%
男女合計	1	5.9%	1	3.7%	2	4.8%	2	3.8%	3	4.3%	2	3.0%	1	1.5%	13	5.2%	25	4.3%
全体(人)																		
男性	12		13		20		25		32		35		33		119		289	
女性	5		14		22		27		37		32		32		130		299	
男女合計	17		27		42		52		69		67		65		249		588	

南 会 津

	10	割合	20	割合	30	割合	40	割合	50	割合	64	割合	69	割合	70～	割合	全体数	割合
1と回答																		
男性	1	50.0%	1	50.0%	1	100.0%	3	100.0%	2	66.7%	3	100.0%	3	75.0%	12	60.0%	26	68.4%
女性	1	33.3%	0	0.0%	1	100.0%	4	80.0%	2	66.7%	1	50.0%	5	83.3%	7	46.7%	21	60.0%
男女合計	2	40.0%	1	50.0%	2	100.0%	7	87.5%	4	66.7%	4	80.0%	8	80.0%	19	54.3%	47	64.4%
2と回答																		
男性	1	50.0%	1	50.0%	0	0.0%	0	0.0%	1	33.3%	0	0.0%	1	25.0%	7	35.0%	11	28.9%
女性	2	66.7%	0	0.0%	0	0.0%	1	20.0%	0	0.0%	1	50.0%	1	16.7%	6	40.0%	11	31.4%
男女合計	3	60.0%	1	50.0%	0	0.0%	1	12.5%	1	16.7%	1	20.0%	2	20.0%	13	37.1%	22	30.1%
無回答																		
男性	0	0.0%	0	0.0%	0	0.0%	0	0.0%	0	0.0%	0	0.0%	0	0.0%	1	5.0%	1	2.6%
女性	0	0.0%	0	0.0%	0	0.0%	0	0.0%	1	33.3%	0	0.0%	0	0.0%	2	13.3%	3	8.6%
男女合計	0	0.0%	0	0.0%	0	0.0%	0	0.0%	1	16.7%	0	0.0%	0	0.0%	3	8.6%	4	5.5%
全体(人)																		
男性	2		2		1		3		3		3		4		20		38	
女性	3		0		1		5		3		2		6		15		35	
男女合計	5		2		2		8		6		5		10		35		73	

相 双

	10	割合	20	割合	30	割合	40	割合	50	割合	64	割合	69	割合	70～	割合	全体数	割合
1と回答																		
男性	4	100.0%	9	100.0%	9	90.0%	5	62.5%	10	83.3%	10	76.9%	21	84.0%	32	82.1%	100	83.3%
女性	1	100.0%	3	60.0%	5	62.5%	9	81.8%	17	81.0%	10	66.7%	20	87.0%	37	77.1%	102	77.3%
男女合計	5	100.0%	12	85.7%	14	77.8%	14	73.7%	27	81.8%	20	71.4%	41	85.4%	69	79.3%	202	80.2%
2と回答																		
男性	0	0.0%	0	0.0%	1	10.0%	1	12.5%	2	16.7%	3	23.1%	3	12.0%	5	12.8%	15	12.5%
女性	0	0.0%	2	40.0%	3	37.5%	1	9.1%	4	19.0%	5	33.3%	3	13.0%	10	20.8%	28	21.2%
男女合計	0	0.0%	2	14.3%	4	22.2%	2	10.5%	6	18.2%	8	28.6%	6	12.5%	15	17.2%	43	17.1%
無回答																		
男性	0	0.0%	0	0.0%	0	0.0%	2	25.0%	0	0.0%	0	0.0%	1	4.0%	2	5.1%	5	4.2%
女性	0	0.0%	0	0.0%	0	0.0%	1	9.1%	0	0.0%	0	0.0%	0	0.0%	1	2.1%	2	1.5%
男女合計	0	0.0%	0	0.0%	0	0.0%	3	15.8%	0	0.0%	0	0.0%	1	2.1%	3	3.4%	7	2.8%
全体(人)																		
男性	4		9		10		8		12		13		25		39		120	
女性	1		5		8		11		21		15		23		48		132	
男女合計	5		14		18		19		33		28		48		87		252	

い わ き

	10	割合	20	割合	30	割合	40	割合	50	割合	64	割合	69	割合	70～	割合	全体数	割合
1と回答																		
男性	9	75.0%	11	52.4%	43	84.3%	48	88.9%	41	83.7%	21	84.0%	24	64.9%	67	67.7%	264	75.9%
女性	4	36.4%	15	68.2%	28	70.0%	36	66.7%	37	64.9%	25	78.1%	21	58.3%	78	64.5%	244	65.4%
男女合計	13	56.5%	26	60.5%	71	78.0%	84	77.8%	78	73.6%	46	80.7%	45	61.6%	145	65.9%	508	70.5%
2と回答																		
男性	3	25.0%	8	38.1%	7	13.7%	5	9.3%	7	14.3%	3	12.0%	13	35.1%	29	29.3%	75	21.6%
女性	7	63.6%	5	22.7%	12	30.0%	16	29.6%	19	33.3%	6	18.8%	13	36.1%	37	30.6%	115	30.8%
男女合計	10	43.5%	13	30.2%	19	20.9%	21	19.4%	26	24.5%	9	15.8%	26	35.6%	66	30.0%	190	26.4%
無回答																		
男性	0	0.0%	2	9.5%	1	2.0%	1	1.9%	1	2.0%	1	4.0%	0	0.0%	3	3.0%	9	2.6%
女性	0	0.0%	2	9.1%	0	0.0%	2	3.7%	1	1.8%	1	3.1%	2	5.6%	6	5.0%	14	3.8%
男女合計	0	0.0%	4	9.3%	1	1.1%	3	2.8%	2	1.9%	2	3.5%	2	2.7%	9	4.1%	23	3.2%
全体(人)																		
男性	12		21		51		54		49		25		37		99		348	
女性	11		22		40		54		57		32		36		121		373	
男女合計	23		43		91		108		106		57		73		220		721	

全 県 (60歳以上・再掲)

	64	割合	69	割合	70	割合	80	割合	90	割合	全体数	割合
1と回答												
男性	163	82.7%	185	75.5%	274	68.8%	126	62.1%	6	33.3%	754	71.1%
女性	164	80.8%	175	68.6%	273	74.2%	139	55.8%	16	30.2%	767	68.0%
男女合計	327	81.8%	360	72.0%	547	71.4%	265	58.6%	22	31.0%	1521	69.5%
2と回答												
男性	29	14.7%	53	21.6%	109	27.4%	65	32.0%	10	55.6%	266	25.1%
女性	36	17.7%	70	27.5%	79	21.5%	88	35.3%	31	58.5%	304	27.0%
男女合計	65	16.3%	123	24.6%	188	24.5%	153	33.8%	41	57.7%	570	26.0%
無回答												
男性	5	2.5%	7	2.9%	15	3.8%	12	5.9%	2	11.1%	41	3.9%
女性	3	1.5%	10	3.9%	16	4.3%	22	8.8%	6	11.3%	57	5.1%
男女合計	8	2.0%	17	3.4%	31	4.0%	34	7.5%	8	11.3%	98	4.5%
全体(人)												
男性	197		245		398		203		18		1061	
女性	203		255		368		249		53		1128	
男女合計	400		500		766		452		71		2189	

21 健診（検診）受診の機会（満15歳以上対象）（調査票 問21）

問21 どのような機会に健診等を受けましたか。（あてはまるものすべてに○）

- 1 市町村が実施した健診
- 2 勤め先、または健康保険組合等が実施した健診
- 3 学校が実施した健診（学生として受診した健診）
- 4 人間ドック（1～3以外の健診で行うもの）
- 5 その他

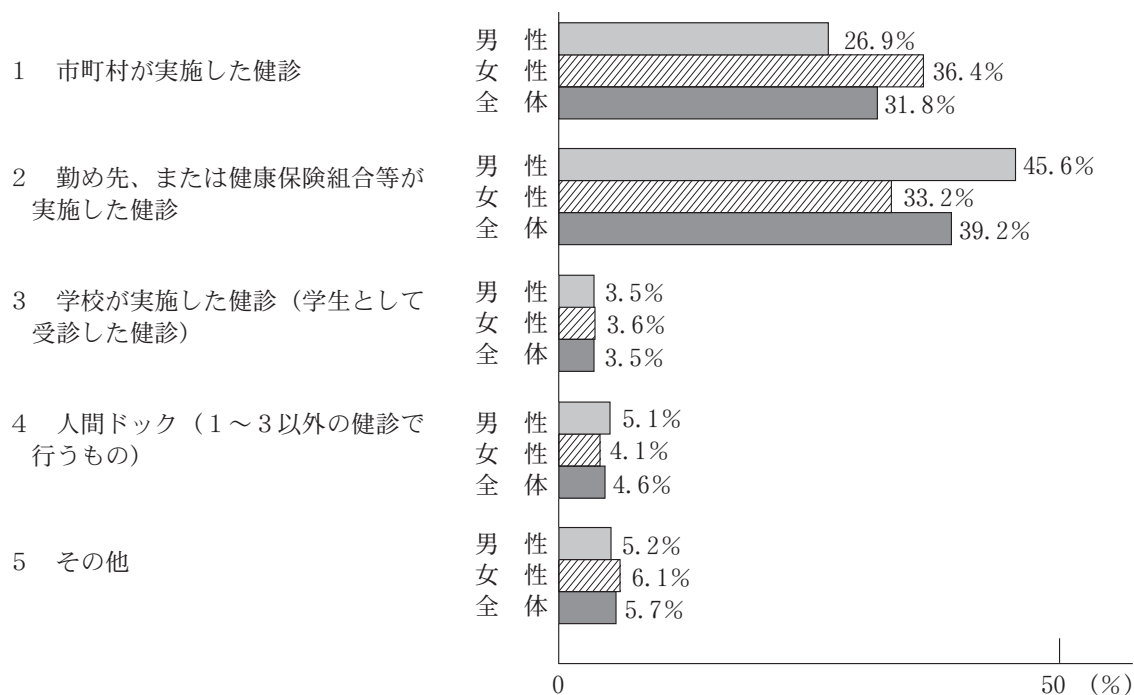

1. 市町村が実施した健診と回答した人

	10	割合	20	割合	30	割合	40	割合	50	割合	64	割合	69	割合	70	割合	80	割合	90	割合	全体数	割合
1に○																						
男性	1	1.3%	7	5.8%	8	3.9%	19	7.5%	26	9.6%	45	22.8%	101	41.2%	219	55.0%	102	50.2%	6	33.3%	534	26.9%
女性	1	1.5%	6	4.9%	34	19.7%	46	18.0%	91	27.5%	95	46.8%	132	51.8%	227	61.7%	119	47.8%	6	11.3%	757	36.4%
男女合計	2	1.4%	13	5.4%	42	11.1%	65	12.8%	117	19.4%	140	35.0%	233	46.6%	446	58.2%	221	48.9%	12	16.9%	1291	31.8%
全体(人)																						
男性	76		120		206		253		272		197		245		398		203		18		1988	
女性	68		122		173		256		331		203		255		368		249		53		2078	
男女合計	144		242		379		509		603		400		500		766		452		71		4066	

2. 勤め先、または健康保険組合等が実施した健診と回答した人

	10	割合	20	割合	30	割合	40	割合	50	割合	64	割合	69	割合	70	割合	80	割合	90	割合	全体数	割合
2に○																						
男性	8	10.5%	63	52.5%	175	85.0%	204	80.6%	208	76.5%	127	64.5%	75	30.6%	43	10.8%	3	1.5%	0	0.0%	906	45.6%
女性	2	2.9%	71	58.2%	108	62.4%	171	66.8%	192	58.0%	76	37.4%	38	14.9%	27	7.3%	3	1.2%	1	1.9%	689	33.2%
男女合計	10	6.9%	134	55.4%	283	74.7%	375	73.7%	400	66.3%	203	50.8%	113	22.6%	70	9.1%	6	1.3%	1	1.4%	1595	39.2%
全体(人)																						
男性	76		120		206		253		272		197		245		398		203		18		1988	
女性	68		122		173		256		331		203		255		368		249		53		2078	
男女合計	144		242		379		509		603		400		500		766		452		71		4066	

3. 学校が実施した健診（学生として受診した健診）と回答した人

	10	割合	20	割合	30	割合	40	割合	50	割合	64	割合	69	割合	70	割合	80	割合	90	割合	全体数	割合
3に○																						
男性	46	60.5%	20	16.7%	1	0.5%	1	0.4%	0	0.0%	0	0.0%	0	0.0%	1	0.3%	0	0.0%	0	0.0%	69	3.5%
女性	47	69.1%	21	17.2%	3	1.7%	2	0.8%	2	0.6%	0	0.0%	0	0.0%	0	0.0%	0	0.0%	0	0.0%	75	3.6%
男女合計	93	64.6%	41	16.9%	4	1.1%	3	0.6%	2	0.3%	0	0.0%	0	0.0%	1	0.1%	0	0.0%	0	0.0%	144	3.5%
全体(人)																						
男性	76		120		206		253		272		197		245		398		203		18		1988	
女性	68		122		173		256		331		203		255		368		249		53		2078	
男女合計	144		242		379		509		603		400		500		766		452		71		4066	

4. 人間ドック（1～3以外の健診で行うもの）と回答した人

	10	割合	20	割合	30	割合	40	割合	50	割合	64	割合	69	割合	70	割合	80	割合	90	割合	全体数	割合
4に○																						
男性	0	0.0%	1	0.8%	0	0.0%	10	4.0%	16	5.9%	16	8.1%	25	10.2%	27	6.8%	7	3.4%	0	0.0%	102	5.1%
女性	0	0.0%	1	0.8%	0	0.0%	11	4.3%	16	4.8%	15	7.4%	18	7.1%	15	4.1%	8	3.2%	1	1.9%	85	4.1%
男女合計	0	0.0%	2	0.8%	0	0.0%	21	4.1%	32	5.3%	31	7.8%	43	8.6%	42	5.5%	15	3.3%	1	1.4%	187	4.6%
全体(人)																						
男性	76		120		206		253		272		197		245		398		203		18		1988	
女性	68		122		173		256		331		203		255		368		249		53		2078	
男女合計	144		242		379		509		603		400		500		766		452		71		4066	

5. その他と回答した人

	10	割合	20	割合	30	割合	40	割合	50	割合	64	割合	69	割合	70	割合	80	割合	90	割合	全体数	割合
5に○																						
男性	1	1.3%	4	3.3%	2	1.0%	3	1.2%	11	4.0%	8	4.1%	13	5.3%	34	8.5%	27	13.3%	1	5.6%	104	5.2%
女性	1	1.5%	2	1.6%	3	1.7%	7	2.7%	9	2.7%	9	4.4%	10	3.9%	39	10.6%	34	13.7%	12	22.6%	126	6.1%
男女合計	2	1.4%	6	2.5%	5	1.3%	10	2.0%	20	3.3%	17	4.3%	23	4.6%	73	9.5%	61	13.5%	13	18.3%	230	5.7%
全体(人)																						
男性	76		120		206		253		272		197		245		398		203		18		1988	
女性	68		122		173		256		331		203		255		368		249		53		2078	
男女合計	144		242		379		509		603		400		500		766		452		71		4066	

22 健診（検診）の際、重要視する点（満15歳以上対象）（調査票 問22）

問22 健診等（健康診断、健康診査および人間ドック）を受けるときに、次の項目はどのくらい重要だと思いますか。（各項目につき○は1つ）

- 1 重要
- 2 やや重要
- 3 どちらともいえない
- 4 あまり重要でない
- 5 重要でない

○わかりやすい健診等の情報

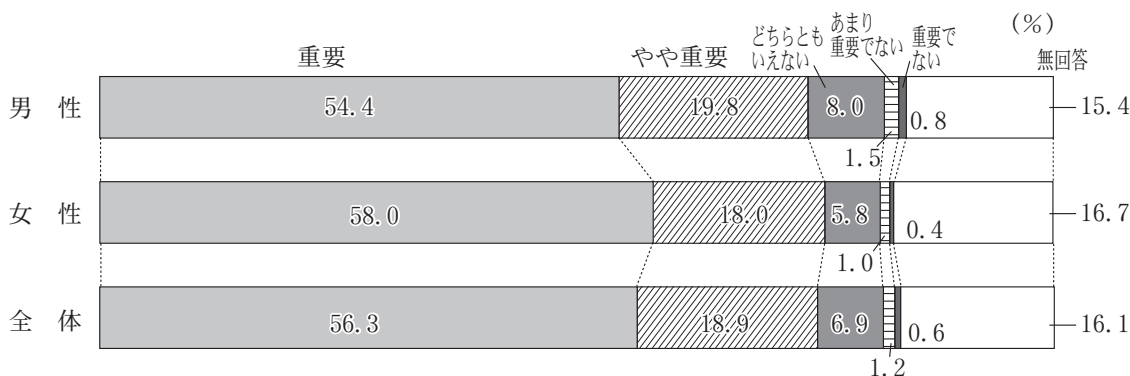

○受診を勧める通知

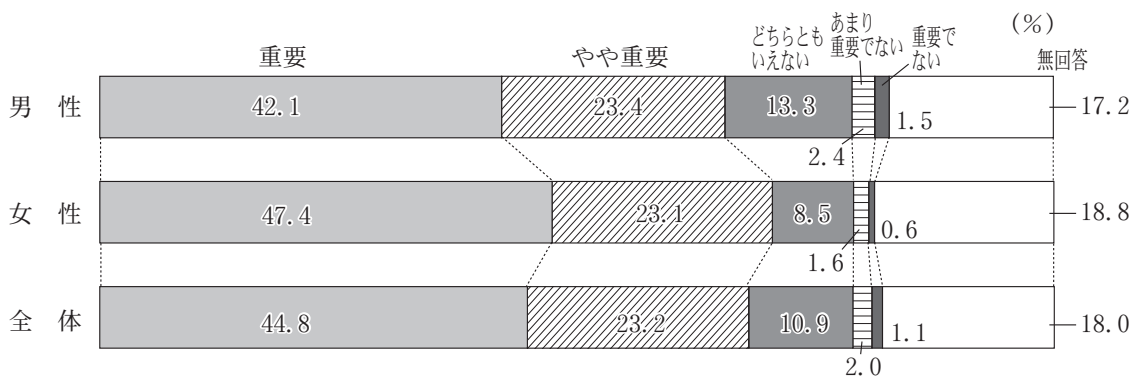

○受診にかかる時間

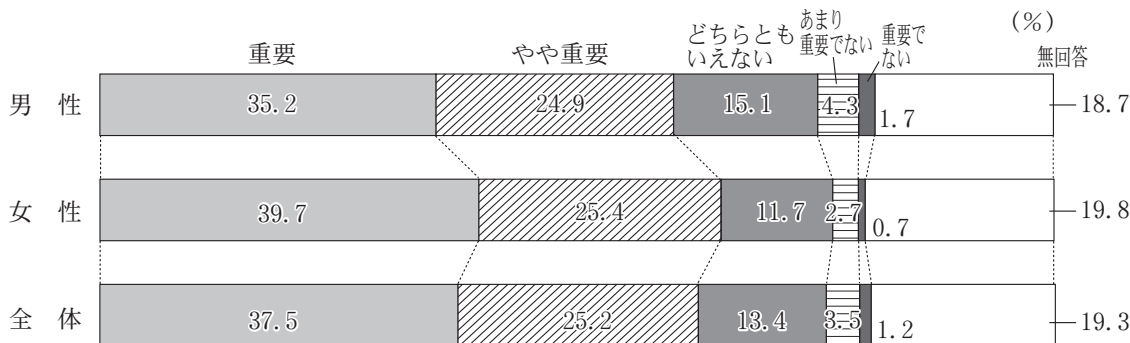

○受診場所の近さ

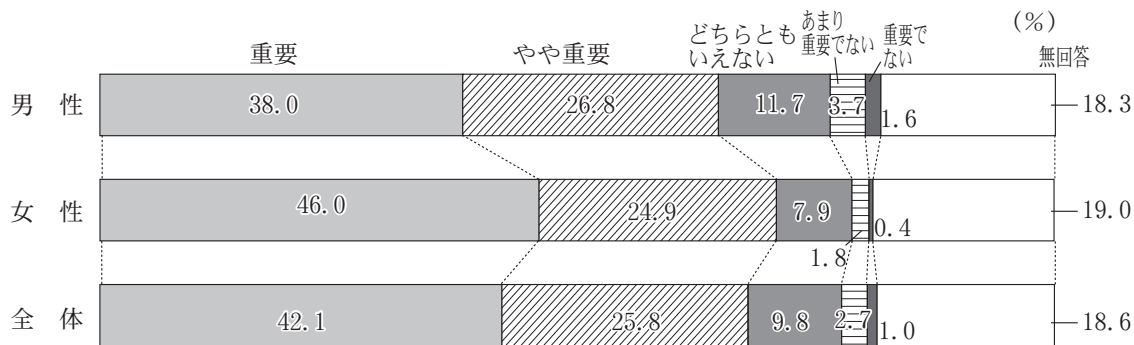

○安い費用

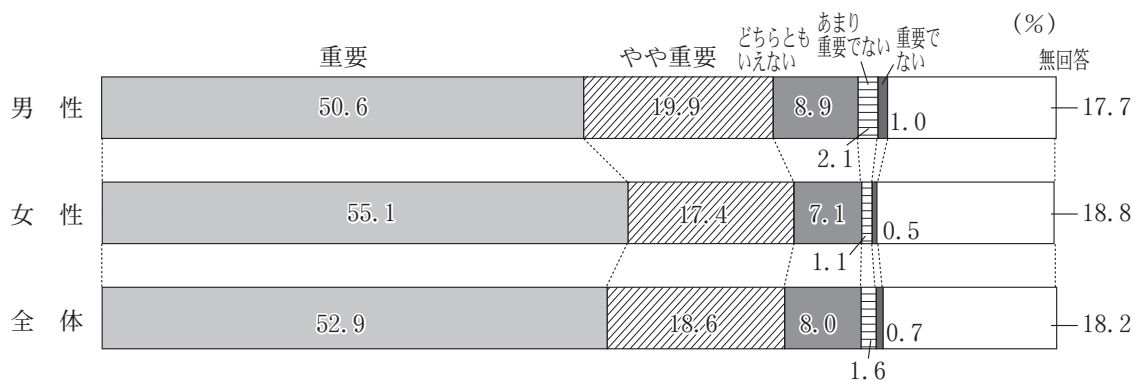

○職場の理解と協力

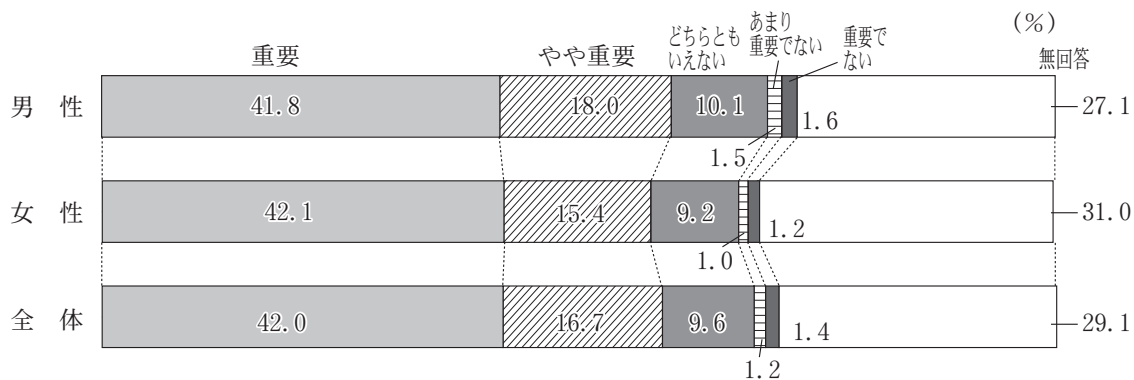

○がん検診等の同時実施

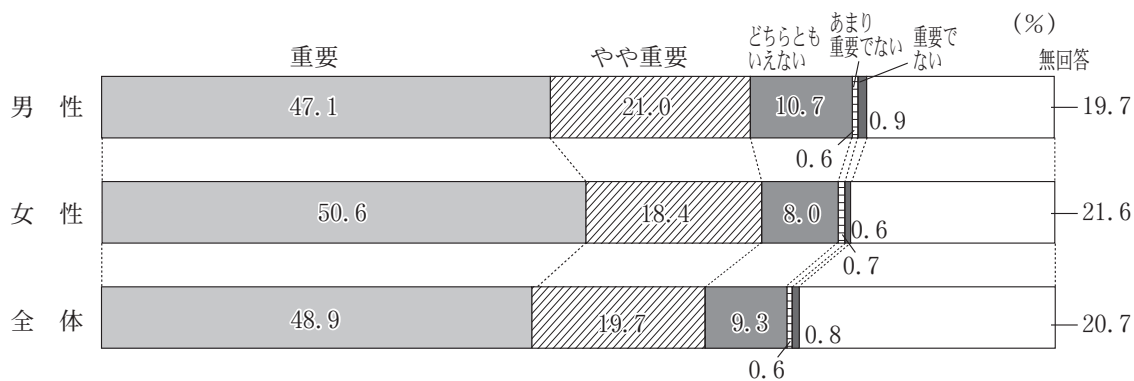

○健診等スタッフの対応

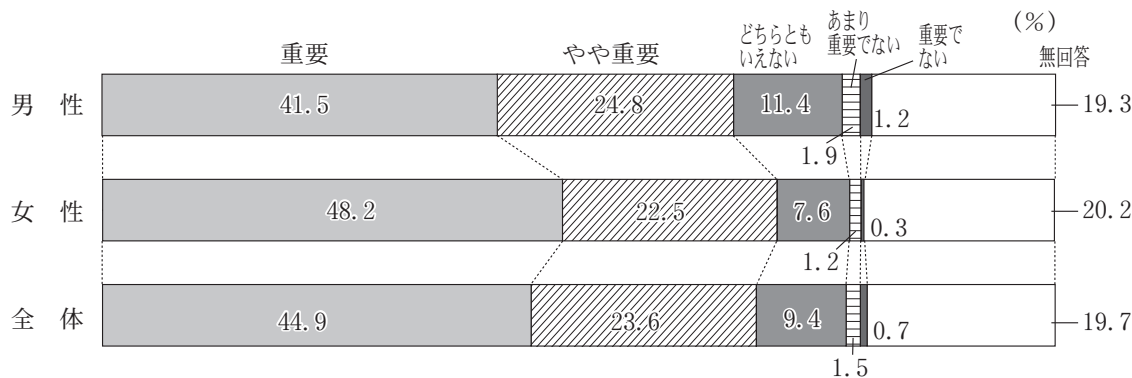

○健診等スタッフの技術

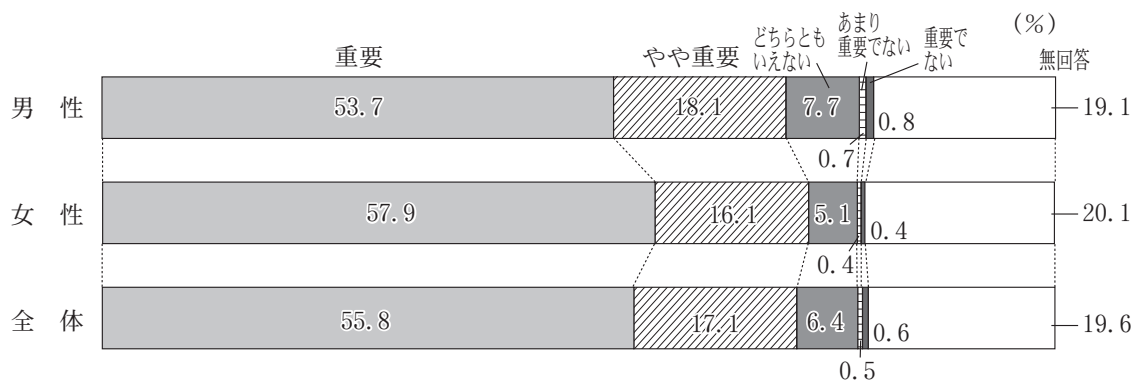

○わかりやすい健診等の情報

	10	割合	20	割合	30	割合	40	割合	50	割合	64	割合	69	割合	70	割合	80	割合	90	割合	全体数	割合
1と回答	40	52.6%	74	61.7%	128	62.1%	152	60.1%	159	58.5%	112	56.9%	131	53.5%	194	48.7%	85	41.9%	7	38.9%	1082	54.4%
男性	41	60.3%	72	59.0%	112	64.7%	174	68.0%	215	65.0%	131	64.5%	146	57.3%	184	50.0%	113	45.4%	18	34.0%	1206	58.0%
女性	41	56.3%	146	60.3%	240	63.3%	326	64.0%	374	62.0%	243	60.8%	277	55.4%	378	49.3%	198	43.8%	25	35.2%	2288	56.3%
男女合計	81	56.3%	146	60.3%	240	63.3%	326	64.0%	374	62.0%	243	60.8%	277	55.4%	378	49.3%	198	43.8%	25	35.2%	2288	56.3%
2と回答	13	17.1%	18	15.0%	46	22.3%	53	20.9%	57	21.0%	53	26.9%	52	21.2%	72	18.1%	29	14.3%	1	5.6%	394	19.8%
男性	18	26.5%	33	27.0%	41	23.7%	39	15.2%	67	20.2%	41	20.2%	43	16.9%	61	16.6%	26	10.4%	6	11.3%	375	18.0%
女性	31	21.5%	51	21.1%	87	23.0%	92	18.1%	124	20.6%	94	23.5%	95	19.0%	133	17.4%	55	12.2%	7	9.9%	769	18.9%
男女合計	31	21.5%	51	21.1%	87	23.0%	92	18.1%	124	20.6%	94	23.5%	95	19.0%	133	17.4%	55	12.2%	7	9.9%	769	18.9%
3と回答	11	14.5%	13	10.8%	14	6.8%	23	9.1%	24	8.8%	11	5.6%	23	9.4%	30	7.5%	6	3.0%	5	27.8%	160	8.0%
男性	4	5.9%	7	5.7%	6	3.5%	17	6.6%	23	6.9%	12	5.9%	16	6.3%	20	5.4%	12	4.8%	4	7.5%	121	5.8%
女性	4	5.9%	7	5.7%	6	3.5%	17	6.6%	23	6.9%	12	5.9%	16	6.3%	20	5.4%	12	4.8%	4	7.5%	121	5.8%
男女合計	15	10.4%	20	8.3%	20	5.3%	40	7.9%	47	7.8%	23	5.8%	39	7.8%	50	6.5%	18	4.0%	9	12.7%	281	6.9%
4と回答	0	0.0%	2	1.7%	5	2.4%	6	2.4%	7	2.6%	3	1.5%	3	1.2%	4	1.0%	0	0.0%	0	0.0%	30	1.5%
男性	0	0.0%	2	1.6%	3	1.7%	4	1.6%	4	1.2%	1	0.5%	3	1.2%	1	0.3%	2	0.8%	0	0.0%	20	1.0%
女性	0	0.0%	4	1.7%	8	2.1%	10	2.0%	11	1.8%	4	1.0%	6	1.2%	5	0.7%	2	0.4%	0	0.0%	50	1.2%
男女合計	0	0.0%	4	1.7%	8	2.1%	10	2.0%	11	1.8%	4	1.0%	6	1.2%	5	0.7%	2	0.4%	0	0.0%	50	1.2%
5と回答	0	0.0%	3	2.5%	0	0.0%	1	0.4%	3	1.1%	1	0.5%	1	0.4%	1	0.3%	5	2.5%	0	0.0%	15	0.8%
男性	0	0.0%	0	0.0%	1	0.6%	1	0.4%	0	0.0%	0	0.0%	2	0.8%	2	0.5%	3	1.2%	0	0.0%	9	0.4%
女性	0	0.0%	3	2.5%	0	0.0%	1	0.4%	3	1.1%	1	0.5%	1	0.4%	1	0.3%	5	2.5%	0	0.0%	15	0.8%
男女合計	0	0.0%	3	2.5%	0	0.0%	1	0.4%	3	1.1%	1	0.5%	1	0.4%	1	0.3%	5	2.5%	0	0.0%	15	0.8%
無回答	12	15.8%	10	8.3%	13	6.3%	18	7.1%	22	8.1%	17	8.6%	35	14.3%	97	24.4%	78	38.4%	5	27.8%	307	15.4%
男性	5	7.4%	8	6.6%	10	5.8%	21	8.2%	22	6.6%	18	8.9%	45	17.6%	100	27.2%	93	37.3%	25	47.2%	347	16.7%
女性	5	7.4%	8	6.6%	10	5.8%	21	8.2%	22	6.6%	18	8.9%	45	17.6%	100	27.2%	93	37.3%	25	47.2%	347	16.7%
男女合計	17	11.8%	18	7.4%	23	6.1%	39	7.7%	44	7.3%	35	8.8%	80	16.0%	197	25.7%	171	37.8%	30	42.3%	654	16.1%
全体(人)	76		120		206		253		272		197		245		398		203		18		1988	
男性	68		122		173		256		331		203		255		368		249		53		2078	
女性	68		122		173		256		331		203		255		368		249		53		2078	
男女合計	144		242		379		509		603		400		500		766		452		71		4066	

○受診を勧める通知

	10	割合	20	割合	30	割合	40	割合	50	割合	64	割合	69	割合	70	割合	80	割合	90	割合	全体数	割合
1と回答	29	38.2%	54	45.0%	101	49.0%	95	37.5%	115	42.3%	92	46.7%	111	45.3%	170	42.7%	63	31.0%	7	38.9%	837	42.1%
男性	29	42.6%	57	46.7%	90	52.0%	132	51.6%	185	55.9%	111	54.7%	121	47.5%	150	40.8%	93	37.3%	17	32.1%	985	47.4%
女性	58	40.3%	111	45.9%	191	50.4%	227	44.6%	300	49.8%	203	50.8%	232	46.4%	320	41.8%	156	34.5%	24	33.8%	1822	44.8%
男女合計	29	42.6%	57	46.7%	90	52.0%	132	51.6%	185	55.9%	111	54.7%	121	47.5%	150	40.8%	93	37.3%	17	32.1%	985	47.4%
2と回答	16	21.1%	24	20.0%	51	24.8%	75	29.6%	70	25.7%	54	27.4%	66	26.9%	76	19.1%	33	16.3%	1	5.6%	466	23.4%
男性	18	26.5%	38	31.1%	62	35.8%	70	27.3%	88	26.6%	57	28.1%	56	22.0%	60	16.3%	24	9.6%	6	11.3%	479	23.1%
女性	34	23.6%	62	25.6%	113	29.8%	145	28.5%	158	26.2%	111	27.8%	122	24.4%	136	17.8%	57	12.6%	7	9.9%	945	23.2%
男女合計	34	23.6%	62	25.6%	113	29.8%	145	28.5%	158	26.2%	111	27.8%	122	24.4%	136	17.8%	57	12.6%	7	9.9%	945	23.2%
3と回答	17	22.4%	25	20.8%	28	13.6%	50	19.8%	43	15.8%	22	11.2%	24	9.8%	42	10.6%	10	4.9%	4	22.2%	265	13.3%
男性	14	20.6%	17	13.9%	7	4.0%	22	8.6%	26	7.9%	14	6.9%	26	10.2%	31	8.4%	16	6.4%	4	7.5%	177	8.5%
女性	31	21.5%	42	17.4%	35	9.2%	72	14.1%	69	11.4%	36	9.0%	50	10.0%	73	9.5%	26	5.8%	8	11.3%	442	10.9%
男女合計	31	21.5%	42	17.4%	35	9.2%	72	14.1%	69	11.4%	36	9.0%	50	10.0%	73	9.5%	26	5.8%	8	11.3%	442	10.9%
4と回答	1	1.3%	3	2.5%	6	2.9%	6	2.4%	14	5.1%	7	3.6%	6	2.4%	4	1.0%	0	0.0%	1	5.6%	48	2.4%
男性	1	1.5%	2	1.6%	2	1.2%	7	2.7%	6	1.8%	2	1.0%	5	2.0%	6	1.6%	2	0.8%	0	0.0%	33	1.6%
女性	2	1.4%	5	2.1%	8	2.1%	13	2.6%	20	3.3%	9	2.3%	11	2.2%	10	1.3%	2	0.4%	1	1.4%	81	2.0%
男女合計	2	1.4%	5	2.1%	8	2.1%	13	2.6%	20	3.3%	9	2.3%	11	2.2%	10	1.3%	2	0.4%	1	1.4%	81	2.0%
5と回答	0	0.0%	4	3.3%	4	1.9%	4	1.6%	6	2.2%	3	1.5%	3	1.2%	1	0.3%	5	2.5%	0	0.0%	30	1.5%
男性	1	1.5%	0	0.0%	1	0.6%	3	1.2%	0	0.0%	0	0.0%	2	0.8%	3	1.2%	0	0.0%	0	0.0%	13	0.6%
女性	1	0.7%	4	1.7%	5	1.3%	7	1.4%	6	1.0%	3	0.8%	5	1.0%	4	0.5%	8	1.8%	0	0.0%	43	1.1%
男女合計	1	0.7%	4	1.7%	5	1.3%	7	1.4%	6	1.0%	3	0.8%	5	1.0%	4	0.5%	8	1.8%	0	0.0%	43	1.1%
無回答	13	17.1%	10	8.3%	16	7.8%	23	9.1%	24	8.8%	19	9.6%	35	14.3%	105	26.4%	92	45.3%	5	27.8%	342	17.2%
男性	5	7.4%	8	6.6%	11	6.4%	22	8.6%	26	7.9%	19	9.4%	45	17.6%	118	32.1%	111	44.6%	26	49.1%	391	18.8%
女性	18	12.5%	18	7.4%	27	7.1%	45	8.8%	50	8.3%	38	9.5%	80	16.0%	223	29.1%	203	44.9%	31	43.7%	733	18.0%
男女合計	18	12.5%	18	7.4%	27	7.1%	45	8.8%	50	8.3%	38	9.5%	80	16.0%	223	29.1%	203	44.9%	31	43.7%	733	18.0%
全体(人)	76		120		206		253		272		197		245		398		203		18		1988	
男性	68		122		173		256		331		203		255		368		249		53		2078	
女性	144		242		379		509		603		400		500		766		452		71		4066	

○受診にかかる時間

	10	割合	20	割合	30	割合	40	割合	50	割合	64	割合	69	割合	70	割合	80	割合	90	割合	全体数	割合
1と回答	37	48.7%	51	42.5%	92	44.7%	111	43.9%	102	37.5%	67	34.0%	84	34.3%	112	28.1%	38	18.7%	6	33.3%	700	35.2%
男性	33	48.5%	55	45.1%	85	49.1%	132	51.6%	154	46.5%	96	47.3%	95	37.3%	96	26.1%	67	26.9%	11	20.8%	824	39.7%
女性	70	48.6%	106	43.8%	177	46.7%	243	47.7%	256	42.5%	163	40.8%	179	35.8%	208	27.2%	105	23.2%	17	23.9%	1524	37.5%
男女合計	70	48.6%	106	43.8%	177	46.7%	243	47.7%	256	42.5%	163	40.8%	179	35.8%	208	27.2%	105	23.2%	17	23.9%	1524	37.5%
2と回答	13	17.1%	36	30.0%	59	28.6%	65	25.7%	78	28.7%	66	33.5%	67	27.3%	80	20.1%	28	13.8%	4	22.2%	496	24.9%
男性	17	25.0%	38	31.1%	45	26.0%	66	25.8%	114	34.4%	60	29.6%	69	27.1%	78	21.2%	34	13.7%	6	11.3%	527	25.4%
女性	30	20.8%	74	30.6%	104	27.4%	131	25.7%	192	31.8%	126	31.5%	136	27.2%	158	20.6%	62	13.7%	10	14.1%	1023	25.2%
男女合計	30	20.8%	74	30.6%	104	27.4%	131	25.7%	192	31.8%	126	31.5%	136	27.2%	158	20.6%	62	13.7%	10	14.1%	1023	25.2%
3と回答	12	15.8%	17	14.2%	32	15.5%	37	14.6%	47	17.3%	36	18.3%	34	13.9%	57	14.3%	26	12.8%	3	16.7%	301	15.1%
男性	10	14.7%	16	13.1%	22	12.7%	30	11.7%	32	9.7%	22	10.8%	31	12.2%	50	13.6%	24	9.6%	7	13.2%	244	11.7%
女性	22	15.3%	33	13.6%	54	14.2%	67	13.2%	79	13.1%	58	14.5%	65	13.0%	107	14.0%	50	11.1%	10	14.1%	545	13.4%
男女合計	22	15.3%	33	13.6%	54	14.2%	67	13.2%	79	13.1%	58	14.5%	65	13.0%	107	14.0%	50	11.1%	10	14.1%	545	13.4%
4と回答	0	0.0%	4	3.3%	3	1.5%	16	6.3%	16	5.9%	8	4.1%	12	4.9%	23	5.8%	4	2.0%	0	0.0%	86	4.3%
男性	3	4.4%	5	4.1%	8	4.6%	4	1.6%	3	0.9%	5	2.5%	8	3.1%	16	4.3%	4	1.6%	0	0.0%	56	2.7%
女性	3	2.1%	9	3.7%	11	2.9%	20	3.9%	19	3.2%	13	3.3%	20	4.0%	39	5.1%	8	1.8%	0	0.0%	142	3.5%
男女合計	3	2.1%	9	3.7%	11	2.9%	20	3.9%	19	3.2%	13	3.3%	20	4.0%	39	5.1%	8	1.8%	0	0.0%	142	3.5%
5と回答	1	1.3%	2	1.7%	4	1.9%	4	1.6%	6	2.2%	4	2.0%	4	1.6%	6	1.5%	3	1.5%	0	0.0%	34	1.7%
男性	0	0.0%	0	0.0%	0	0.0%	1	0.4%	2	0.6%	0	0.0%	2	0.8%	4	1.1%	5	2.0%	1	1.9%	15	0.7%
女性	1	0.7%	2	0.8%	4	1.1%	5	1.0%	8	1.3%	4	1.0%	6	1.2%	10	1.3%	8	1.8%	1	1.4%	49	1.2%
男女合計	1	0.7%	2	0.8%	4	1.1%	5	1.0%	8	1.3%	4	1.0%	6	1.2%	10	1.3%	8	1.8%	1	1.4%	49	1.2%
無回答	13	17.1%	10	8.3%	16	7.8%	20	7.9%	23	8.5%	16	8.1%	44	18.0%	120	30.2%	104	51.2%	5	27.8%	371	18.7%
男性	5	7.4%	8	6.6%	13	7.5%	23	9.0%	26	7.9%	20	9.9%	50	19.6%	124	33.7%	115	46.2%	28	52.8%	412	19.8%
女性	18	12.5%	18	7.4%	29	7.7%	43	8.4%	49	8.1%	36	9.0%	94	18.8%	244	31.9%	219	48.5%	33	46.5%	783	19.3%
男女合計	18	12.5%	18	7.4%	29	7.7%	43	8.4%	49	8.1%	36	9.0%	94	18.8%	244	31.9%	219	48.5%	33	46.5%	783	19.3%
全体(人)	76		120		206		253		272		197		245		398		203		18		1988	
男性	68		122		173		256		331		203		255		368		249		53		2078	
女性	144		242		379		509		603		400		500		766		452		71		4066	

○受診場所の近さ

	10	割合	20	割合	30	割合	40	割合	50	割合	64	割合	69	割合	70	割合	80	割合	90	割合	全体数	割合
1と回答	35	46.1%	57	47.5%	94	45.6%	109	43.1%	110	40.4%	78	39.6%	83	33.9%	128	32.2%	52	25.6%	9	50.0%	755	38.0%
男性	36	52.9%	67	54.9%	83	48.0%	135	52.7%	178	53.8%	113	55.7%	118	46.3%	122	33.2%	91	36.5%	13	24.5%	956	46.0%
女性	71	49.3%	124	51.2%	177	46.7%	244	47.9%	288	47.8%	191	47.8%	201	40.2%	250	32.6%	143	31.6%	22	31.0%	1711	42.1%
男女合計	71	49.3%	124	51.2%	177	46.7%	244	47.9%	288	47.8%	191	47.8%	201	40.2%	250	32.6%	143	31.6%	22	31.0%	1711	42.1%
2と回答	15	19.7%	28	23.3%	68	33.0%	69	27.3%	73	26.8%	66	33.5%	85	34.7%	89	22.4%	38	18.7%	1	5.6%	532	26.8%
男性	17	25.0%	31	25.4%	57	32.9%	72	28.1%	96	29.0%	49	24.1%	62	24.3%	91	24.7%	33	13.3%	9	17.0%	517	24.9%

○安い費用

	10	割合	20	割合	30	割合	40	割合	50	割合	64	割合	69	割合	70	割合	80	割合	90	割合	全体数	割合
1と回答																						
男性	39	51.3%	66	55.0%	118	57.3%	147	58.1%	143	52.6%	104	52.8%	127	51.8%	189	47.5%	63	31.0%	9	50.0%	1005	50.6%
女性	43	63.2%	84	68.9%	114	65.9%	155	60.5%	217	65.6%	132	65.0%	142	55.7%	150	40.8%	93	37.3%	15	28.3%	1145	55.1%
男女合計	82	56.9%	150	62.0%	232	61.2%	302	59.3%	360	59.7%	236	59.0%	269	53.8%	339	44.3%	156	34.5%	24	33.8%	2150	52.9%
2と回答																						
男性	11	14.5%	27	22.5%	42	20.4%	53	20.9%	62	22.8%	52	26.4%	51	20.8%	68	17.1%	28	13.8%	1	5.6%	395	19.9%
女性	12	17.6%	19	15.6%	35	20.4%	59	23.0%	66	19.9%	41	20.2%	38	14.9%	59	16.0%	26	10.4%	6	11.3%	361	17.4%
男女合計	23	16.0%	46	19.0%	77	20.3%	112	22.0%	128	21.2%	93	23.3%	89	17.8%	127	16.6%	54	11.9%	7	9.9%	756	18.6%
3と回答																						
男性	12	15.8%	15	12.5%	21	10.2%	25	9.9%	27	9.9%	17	8.6%	13	5.3%	30	7.5%	13	6.4%	3	16.7%	176	8.9%
女性	8	11.8%	9	7.4%	13	7.5%	14	5.5%	22	6.6%	13	6.4%	21	8.2%	32	8.7%	12	4.8%	4	7.5%	148	7.1%
男女合計	20	13.9%	24	9.9%	34	9.0%	39	7.7%	49	8.1%	30	7.5%	34	6.8%	62	8.1%	25	5.5%	7	9.9%	324	8.0%
4と回答																						
男性	1	1.3%	0	0.0%	7	3.4%	4	1.6%	10	3.7%	3	1.5%	10	4.1%	4	1.0%	2	1.0%	0	0.0%	41	2.1%
女性	0	0.0%	2	1.6%	2	1.2%	6	2.3%	2	0.6%	0	0.0%	4	1.6%	5	1.4%	2	0.8%	0	0.0%	23	1.1%
男女合計	1	0.7%	2	0.8%	9	2.4%	10	2.0%	12	2.0%	3	0.8%	14	2.8%	9	1.2%	4	0.9%	0	0.0%	64	1.6%
5と回答																						
男性	0	0.0%	4	3.3%	4	1.9%	4	1.6%	5	1.8%	1	0.5%	1	0.4%	0	0.0%	1	0.5%	0	0.0%	20	1.0%
女性	0	0.0%	1	0.8%	0	0.0%	1	0.4%	1	0.3%	0	0.0%	2	0.8%	2	0.5%	3	1.2%	0	0.0%	10	0.5%
男女合計	0	0.0%	5	2.1%	4	1.1%	5	1.0%	6	1.0%	1	0.3%	3	0.6%	2	0.3%	4	0.9%	0	0.0%	30	0.7%
無回答																						
男性	13	17.1%	8	6.7%	14	6.8%	20	7.9%	25	9.2%	20	10.2%	43	17.6%	107	26.9%	96	47.3%	5	27.8%	351	17.7%
女性	5	7.4%	7	5.7%	9	5.2%	21	8.2%	23	6.9%	17	8.4%	48	18.8%	120	32.6%	113	45.4%	28	52.8%	391	18.8%
男女合計	18	12.5%	15	6.2%	23	6.1%	41	8.1%	48	8.0%	37	9.3%	91	18.2%	227	29.6%	209	46.2%	33	46.5%	742	18.2%
全体(人)																						
男性	76		120		206		253		272		197		245		398		203		18		1988	
女性	68		122		173		256		331		203		255		368		249		53		2078	
男女合計	144		242		379		509		603		400		500		766		452		71		4066	

○職場の理解と協力

	10	割合	20	割合	30	割合	40	割合	50	割合	64	割合	69	割合	70	割合	80	割合	90	割合	全体数	割合
1と回答																						
男性	30	39.5%	64	53.3%	130	63.1%	149	58.9%	143	52.6%	99	50.3%	88	35.9%	97	24.4%	26	12.8%	5	27.8%	831	41.8%
女性	34	50.0%	71	58.2%	110	63.6%	160	62.5%	196	59.2%	94	46.3%	88	34.5%	67	18.2%	67	18.2%	12	22.6%	875	42.1%
男女合計	64	44.4%	135	55.8%	240	63.3%	309	60.7%	339	56.2%	193	48.3%	176	35.2%	164	21.4%	69	15.3%	17	23.9%	1706	42.0%
2と回答																						
男性	12	15.8%	22	18.3%	45	21.8%	54	21.3%	64	23.5%	49	24.9%	42	17.1%	49	12.3%	20	9.9%	1	5.6%	358	18.0%
女性	13	19.1%	33	27.0%	36	20.8%	40	15.6%	67	20.2%	50	24.6%	28	11.0%	34	9.2%	15	6.0%	5	9.4%	321	15.4%
男女合計	25	17.4%	55	22.7%	81	21.4%	94	18.5%	131	21.7%	99	24.8%	70	14.0%	83	10.8%	35	7.7%	6	8.5%	679	16.7%
3と回答																						
男性	18	23.7%	19	15.8%	13	6.3%	27	10.7%	22	8.1%	21	10.7%	25	10.2%	36	9.0%	14	6.9%	5	27.8%	200	10.1%
女性	12	17.6%	9	7.4%	14	8.1%	27	10.5%	26	7.9%	15	7.4%	27	10.6%	35	9.5%	23	9.2%	4	7.5%	192	9.2%
男女合計	30	20.8%	28	11.6%	27	7.1%	54	10.6%	48	8.0%	36	9.0%	52	10.4%	71	9.3%	37	8.2%	9	12.7%	392	9.6%
4と回答																						
男性	0	0.0%	2	1.7%	2	1.0%	3	1.2%	9	3.3%	3	1.5%	5	2.0%	4	1.0%	1	0.5%	0	0.0%	29	1.5%
女性	0	0.0%	0	0.0%	1	0.6%	4	1.6%	1	0.3%	2	1.0%	4	1.6%	5	1.4%	3	1.2%	1	1.9%	21	1.0%
男女合計	0	0.0%	2	0.8%	3	0.8%	7	1.4%	10	1.7%	5	1.3%	9	1.8%	9	1.2%	4	0.9%	1	1.4%	50	1.2%
5と回答																						
男性	1	1.3%	3	2.5%	1	0.5%	0	0.0%	6	2.2%	2	1.0%	8	3.3%	6	1.5%	4	2.0%	0	0.0%	31	1.6%
女性	1	1.5%	0	0.0%	0	0.0%	2	0.8%	4	1.2%	1	0.5%	3	1.2%	9	2.4%	3	1.2%	1	1.9%	24	1.2%
男女合計	2	1.4%	3	1.2%	1	0.3%	2	0.4%	10	1.7%	3	0.8%	11	2.2%	15	2.0%	7	1.5%	1	1.4%	55	1.4%
無回答																						
男性	15	19.7%	10	8.3%	15	7.3%	20	7.9%	28	10.3%	23	11.7%	77	31.4%	206	51.8%	138	68.0%	7	38.9%	539	27.1%
女性	8	11.8%	9	7.4%	12	6.9%	23	9.0%	37	11.2%	41	20.2%	105	41.2%	218	59.2%	162	65.1%	30	56.6%	645	31.0%
男女合計	23	16.0%	19	7.9%	27	7.1%	43	8.4%	65	10.8%	64	16.0%	182	36.4%	424	55.4%	300	66.4%	37	52.1%	1184	29.1%
全体(人)																						
男性	76		120		206		253		272		197		245		398		203		18		1988	
女性	68		122		173		256		331		203		255		368		249		53		2078	
男女合計	144		242		379		509		603		400		500		766		452		71		4066	

○がん検診等の同時実施

	10	割合	20	割合	30	割合	40	割合	50	割合	64	割合	69	割合	70	割合	80	割合	90	割合	全体数	割合
1と回答																						
男性	33	43.4%	55	45.8%	113	54.9%	134	53.0%	130	47.8%	112	56.9%	132	53.9%	167	42.0%	55	27.1%	6	33.3%	937	47.1%
女性	29	42.6%	69	56.6%	107	61.8%	166	64.8%	211	63.7%	121	59.6%	123	48.2%	135	36.7%	78	31.3%	13	24.5%	1052	50.6%
男女合計	62	43.1%	124	51.2%	220	58.0%	300	58.9%	341	56.6%	233	58.3%	255	51.0%	302	39.4%	133	29.4%	19	26.8%	1989	48.9%
2と回答																						
男性	11	14.5%	28	23.3%	47	22.8%	67	26.5%	77	28.3%	42	21.3%	48	19.6%	66	16.6%	28	13.8%	3	16.7%	417	21.0%
女性	22	32.4%	28	23.0%	42	24.3%	45	17.6%	74	22.4%	41	20.2%	43	16.9%	58	15.8%	23	9.2%	7	13.2%	383	18.4%
男女合計	33	22.9%	56	23.1%	89	23.5%	112	22.0%														

○健診等スタッフの対応

	10	割合	20	割合	30	割合	40	割合	50	割合	64	割合	69	割合	70	割合	80	割合	90	割合	全体数	割合
1と回答																						
男性	39	51.3%	53	44.2%	97	47.1%	120	47.4%	114	41.9%	92	46.7%	105	42.9%	149	37.4%	49	24.1%	7	38.9%	825	41.5%
女性	33	48.5%	72	59.0%	97	56.1%	146	57.0%	186	56.2%	121	59.6%	119	46.7%	129	35.1%	86	34.5%	13	24.5%	1002	48.2%
男女合計	72	50.0%	125	51.7%	194	51.2%	266	52.3%	300	49.8%	213	53.3%	224	44.8%	278	36.3%	135	29.9%	20	28.2%	1827	44.9%
2と回答																						
男性	11	14.5%	33	27.5%	56	27.2%	65	25.7%	84	30.9%	57	28.9%	65	26.5%	89	22.4%	32	15.8%	2	11.1%	494	24.8%
女性	21	30.9%	29	23.8%	50	28.9%	66	25.8%	90	27.2%	50	24.6%	54	21.2%	73	19.8%	29	11.6%	5	9.4%	467	22.5%
男女合計	32	22.2%	62	25.6%	106	28.0%	131	25.7%	174	28.9%	107	26.8%	119	23.8%	162	21.1%	61	13.5%	7	9.9%	961	23.6%
3と回答																						
男性	12	15.8%	16	13.3%	30	14.6%	36	14.2%	36	13.2%	23	11.7%	23	9.4%	37	9.3%	10	4.9%	3	16.7%	226	11.4%
女性	7	10.3%	11	9.0%	13	7.5%	17	6.6%	25	7.6%	8	3.9%	27	10.6%	33	9.0%	11	4.4%	6	11.3%	158	7.6%
男女合計	19	13.2%	27	11.2%	43	11.3%	53	10.4%	61	10.1%	31	7.8%	50	10.0%	70	9.1%	21	4.6%	9	12.7%	384	9.4%
4と回答																						
男性	1	1.3%	4	3.3%	4	1.9%	5	2.0%	6	2.2%	4	2.0%	7	2.9%	3	0.8%	3	1.5%	0	0.0%	37	1.9%
女性	2	2.9%	2	1.6%	2	1.2%	3	1.2%	4	1.2%	3	1.5%	3	1.2%	2	0.5%	2	0.8%	1	1.9%	24	1.2%
男女合計	3	2.1%	6	2.5%	6	1.6%	8	1.6%	10	1.7%	7	1.8%	10	2.0%	5	0.7%	5	1.1%	1	1.4%	61	1.5%
5と回答																						
男性	0	0.0%	3	2.5%	5	2.4%	2	0.8%	4	1.5%	0	0.0%	3	1.2%	2	0.5%	4	2.0%	0	0.0%	23	1.2%
女性	0	0.0%	0	0.0%	1	0.6%	1	0.4%	0	0.0%	0	0.0%	2	0.8%	1	0.3%	2	0.8%	0	0.0%	7	0.3%
男女合計	0	0.0%	3	1.2%	6	1.6%	3	0.6%	4	0.7%	0	0.0%	5	1.0%	3	0.4%	6	1.3%	0	0.0%	30	0.7%
無回答																						
男性	13	17.1%	11	9.2%	14	6.8%	25	9.9%	28	10.3%	21	10.7%	42	17.1%	118	29.6%	105	51.7%	6	33.3%	383	19.3%
女性	5	7.4%	8	6.6%	10	5.8%	23	9.0%	26	7.9%	21	10.3%	50	19.6%	130	35.3%	119	47.8%	28	52.8%	420	20.2%
男女合計	18	12.5%	19	7.9%	24	6.3%	48	9.4%	54	9.0%	42	10.5%	92	18.4%	248	32.4%	224	49.6%	34	47.9%	803	19.7%
全体(人)																						
男性	76		120		206		253		272		197		245		398		203		18		1988	
女性	68		122		173		256		331		203		255		368		249		53		2078	
男女合計	144		242		379		509		603		400		500		766		452		71		4066	

○健診等スタッフの技術

	10	割合	20	割合	30	割合	40	割合	50	割合	64	割合	69	割合	70	割合	80	割合	90	割合	全体数	割合
1と回答																						
男性	43	56.6%	70	58.3%	120	58.3%	154	60.9%	162	59.6%	125	63.5%	138	56.3%	185	46.5%	63	31.0%	7	38.9%	1067	53.7%
女性	37	54.4%	79	64.8%	114	65.9%	182	71.1%	229	69.2%	145	71.4%	148	58.0%	159	43.2%	98	39.4%	12	22.6%	1203	57.9%
男女合計	80	55.6%	149	61.6%	234	61.7%	336	66.0%	391	64.8%	270	67.5%	286	57.2%	344	44.9%	161	35.6%	19	26.8%	2270	55.8%
2と回答																						
男性	10	13.2%	26	21.7%	53	25.7%	48	19.0%	52	19.1%	35	17.8%	45	18.4%	66	16.6%	22	10.8%	2	11.1%	359	18.1%
女性	20	29.4%	27	22.1%	42	24.3%	36	14.1%	61	18.4%	31	15.3%	38	14.9%	51	13.9%	22	8.8%	7	13.2%	335	16.1%
男女合計	30	20.8%	53	21.9%	95	25.1%	84	16.5%	113	18.7%	66	16.5%	83	16.6%	117	15.3%	44	9.7%	9	12.7%	694	17.1%
3と回答																						
男性	10	13.2%	10	8.3%	17	8.3%	23	9.1%	23	8.5%	16	8.1%	18	7.3%	23	5.8%	10	4.9%	3	16.7%	153	7.7%
女性	5	7.4%	7	5.7%	7	4.0%	14	5.5%	14	4.2%	5	2.5%	15	5.9%	24	6.5%	10	4.0%	5	9.4%	106	5.1%
男女合計	15	10.4%	17	7.0%	24	6.3%	37	7.3%	37	6.1%	21	5.3%	33	6.6%	47	6.1%	20	4.4%	8	11.3%	259	6.4%
4と回答																						
男性	0	0.0%	1	0.8%	0	0.0%	2	0.8%	3	1.1%	3	1.5%	2	0.8%	3	0.8%	0	0.0%	0	0.0%	14	0.7%
女性	1	1.5%	1	0.8%	0	0.0%	1	0.4%	0	0.0%	0	0.0%	2	0.8%	1	0.3%	1	0.4%	1	1.9%	8	0.4%
男女合計	1	0.7%	2	0.8%	0	0.0%	3	0.6%	3	0.5%	3	0.8%	4	0.8%	4	0.5%	1	0.2%	1	1.4%	22	0.5%
5と回答																						
男性	0	0.0%	3	2.5%	2	1.0%	1	0.4%	4	1.5%	0	0.0%	0	0.0%	1	0.3%	4	2.0%	1	5.6%	16	0.8%
女性	0	0.0%	0	0.0%	0	0.0%	1	0.4%	0	0.0%	0	0.0%	2	0.8%	2	0.5%	3	1.2%	0	0.0%	8	0.4%
男女合計	0	0.0%	3	1.2%	2	0.5%	2	0.4%	4	0.7%	0	0.0%	2	0.4%	3	0.4%	7	1.5%	1	1.4%	24	0.6%
無回答																						
男性	13	17.1%	10	8.3%	14	6.8%	25	9.9%	28	10.3%	18	9.1%	42	17.1%	120	30.2%	104	51.2%	5	27.8%	379	19.1%
女性	5	7.4%	8	6.6%	10	5.8%	22	8.6%	27	8.2%	22	10.8%	50	19.6%	131	35.6%	115	46.2%	28	52.8%	418	20.1%
男女合計	18	12.5%	18	7.4%	24	6.3%	47	9.2%	55	9.1%	40	10.0%	92	18.4%	251	32.8%	219	48.5%	33	46.5%	797	19.6%
全体(人)																						
男性	76		120		206		253		272		197		245		398		203		18		1988	
女性	68		122		173		256		331		203		255		368		249		53		2078	
男女合計	144		242		379		509		603		400		500		766		452		71		4066	

23 睡眠時間の状況（満15歳以上対象）（調査票 問23）

問23 あなたは、ふだんの睡眠時間は、どのくらいですか。あてはまる番号を1つ選んで○をつけてください。

- 1 4時間以下 2 5時間位 3 6時間位
4 7時間位 5 8時間位 6 9時間以上

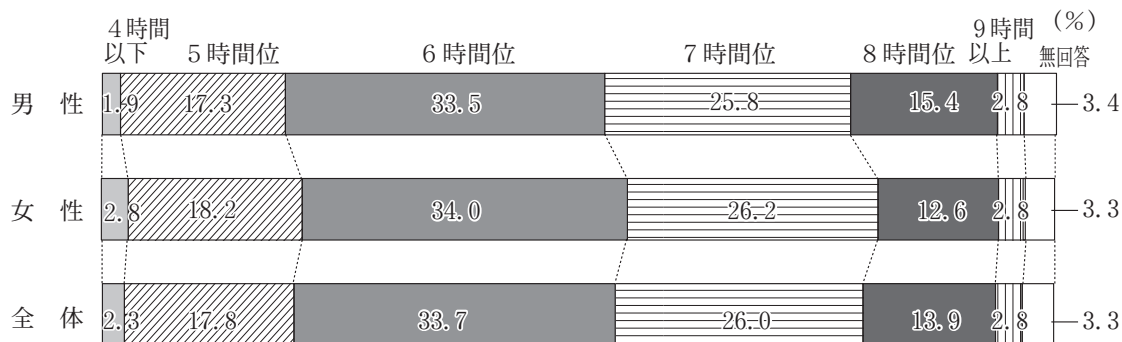

	10	割合	20	割合	30	割合	40	割合	50	割合	64	割合	69	割合	70	割合	80	割合	90	割合	全体数	割合
1と回答																						
男性	0	0.0%	2	1.7%	3	1.5%	11	4.3%	8	2.9%	3	1.5%	1	0.4%	7	1.8%	1	0.5%	1	5.6%	37	1.9%
女性	6	8.8%	3	2.5%	3	1.7%	16	6.3%	10	3.0%	2	1.0%	4	1.6%	8	2.2%	6	2.4%	0	0.0%	58	2.8%
男女合計	6	4.2%	5	2.1%	6	1.6%	27	5.3%	18	3.0%	5	1.3%	5	1.0%	15	2.0%	7	1.5%	1	1.4%	95	2.3%
2と回答																						
男性	16	21.1%	22	18.3%	50	24.3%	70	27.7%	54	19.9%	40	20.3%	29	11.8%	45	11.3%	17	8.4%	1	5.6%	344	17.3%
女性	8	11.8%	21	17.2%	28	16.2%	72	28.1%	85	25.7%	43	21.2%	36	14.1%	57	15.5%	26	10.4%	3	5.7%	379	18.2%
男女合計	24	16.7%	43	17.8%	78	20.6%	142	27.9%	139	23.1%	83	20.8%	65	13.0%	102	13.3%	43	9.5%	4	5.6%	723	17.8%
3と回答																						
男性	41	53.9%	47	39.2%	91	44.2%	83	32.8%	97	35.7%	73	37.1%	74	30.2%	114	28.6%	41	20.2%	4	22.2%	665	33.5%
女性	24	35.3%	49	40.2%	75	43.4%	92	35.9%	130	39.3%	82	40.4%	82	32.2%	121	32.9%	49	19.7%	3	5.7%	707	34.0%
男女合計	65	45.1%	96	39.7%	166	43.8%	175	34.4%	227	37.6%	155	38.8%	156	31.2%	235	30.7%	90	19.9%	7	9.9%	1372	33.7%
4と回答																						
男性	11	14.5%	37	30.8%	43	20.9%	53	20.9%	77	28.3%	53	26.9%	83	33.9%	105	26.4%	49	24.1%	2	11.1%	513	25.8%
女性	21	30.9%	30	24.6%	44	25.4%	52	20.3%	68	20.5%	52	25.6%	90	35.3%	118	32.1%	59	23.7%	11	20.8%	545	26.2%
男女合計	32	22.2%	67	27.7%	87	23.0%	105	20.6%	145	24.0%	105	26.3%	173	34.6%	223	29.1%	108	23.9%	13	18.3%	1058	26.0%
5と回答																						
男性	2	2.6%	8	6.7%	11	5.3%	25	9.9%	24	8.8%	23	11.7%	48	19.6%	93	23.4%	66	32.5%	6	33.3%	306	15.4%
女性	7	10.3%	12	9.8%	21	12.1%	15	5.9%	25	7.6%	21	10.3%	31	12.2%	47	12.8%	65	26.1%	17	32.1%	261	12.6%
男女合計	9	6.3%	20	8.3%	32	8.4%	40	7.9%	49	8.1%	44	11.0%	79	15.8%	140	18.3%	131	29.0%	23	32.4%	567	13.9%
6と回答																						
男性	2	2.6%	0	0.0%	0	0.0%	3	1.2%	4	1.5%	1	0.5%	4	1.6%	21	5.3%	18	8.9%	3	16.7%	56	2.8%
女性	1	1.5%	2	1.6%	0	0.0%	2	0.8%	3	0.9%	1	0.5%	2	0.8%	5	1.4%	31	12.4%	12	22.6%	59	2.8%
男女合計	3	2.1%	2	0.8%	0	0.0%	5	1.0%	7	1.2%	2	0.5%	6	1.2%	26	3.4%	49	10.8%	15	21.1%	115	2.8%
無回答																						
男性	4	5.3%	4	3.3%	8	3.9%	8	3.2%	8	2.9%	4	2.0%	6	2.4%	13	3.3%	11	5.4%	1	5.6%	67	3.4%
女性	1	1.5%	5	4.1%	2	1.2%	7	2.7%	10	3.0%	2	1.0%	10	3.9%	12	3.3%	13	5.2%	7	13.2%	69	3.3%
男女合計	5	3.5%	9	3.7%	10	2.6%	15	2.9%	18	3.0%	6	1.5%	16	3.2%	25	3.3%	24	5.3%	8	11.3%	136	3.3%
全体(人)																						
男性	76		120		206		253		272		197		245		398		203		18		1988	
女性	68		122		173		256		331		203		255		368		249		53		2078	
男女合計	144		242		379		509		603		400		500		766		452		71		4066	

県 北

	10	割合	20	割合	30	割合	40	割合	50	割合	64	割合	69	割合	70～	割合	全体数	割合
1と回答																		
男性	0	0.0%	1	2.6%	2	3.4%	4	5.6%	4	5.1%	3	5.4%	0	0.0%	1	0.6%	15	2.7%
女性	2	8.7%	1	2.2%	1	2.2%	3	4.4%	2	2.0%	1	2.0%	0	0.0%	3	1.7%	13	2.2%
男女合計	2	3.8%	2	2.4%	3	2.9%	7	5.0%	6	3.4%	4	3.8%	0	0.0%	4	1.1%	28	2.4%
2と回答																		
男性	4	13.8%	6	15.8%	16	27.6%	24	33.8%	16	20.3%	10	17.9%	5	7.8%	19	11.2%	100	17.7%
女性	2	8.7%	9	20.0%	6	13.3%	23	33.8%	30	30.0%	9	18.0%	11	16.7%	29	16.0%	119	20.6%
男女合計	6	11.5%	15	18.1%	22	21.4%	47	33.8%	46	25.7%	19	17.9%	16	12.3%	48	13.7%	219	19.2%
3と回答																		
男性	19	65.5%	22	57.9%	23	39.7%	20	28.2%	28	35.4%	20	35.7%	19	29.7%	35	20.6%	186	32.9%
女性	9	39.1%	17	37.8%	21	46.7%	25	36.8%	36	36.0%	23	46.0%	18	27.3%	48	26.5%	197	34.1%
男女合計	28	53.8%	39	47.0%	44	42.7%	45	32.4%	64	35.8%	43	40.6%	37	28.5%	83	23.6%	383	33.5%
4と回答																		
男性	4	13.8%	6	15.8%	10	17.2%	11	15.5%	21	26.6%	15	26.8%	25	39.1%	49	28.8%	141	25.0%
女性	8	34.8%	9	20.0%	11	24.4%	13	19.1%	19	19.0%	14	28.0%	27	40.9%	47	26.0%	148	25.6%
男女合計	12	23.1%	15	18.1%	21	20.4%	24	17.3%	40	22.3%	29	27.4%	52	40.0%	96	27.4%	289	25.3%
5と回答																		
男性	0	0.0%	2	5.3%	4	6.9%	7	9.9%	6	7.6%	6	10.7%	11	17.2%	43	25.3%	79	14.0%
女性	1	4.3%	6	13.3%	4	8.9%	1	1.5%	10	10.0%	3	6.0%	5	7.6%	31	17.1%	61	10.6%
男女合計	1	1.9%	8	9.6%	8	7.8%	8	5.8%	16	8.9%	9	8.5%	16	12.3%	74	21.1%	140	12.2%
6と回答																		
男性	0	0.0%	0	0.0%	0	0.0%	1	1.4%	0	0.0%	0	0.0%	2	3.1%	15	8.8%	18	3.2%
女性	0	0.0%	1	2.2%	0	0.0%	0	0.0%	1	1.0%	0	0.0%	0	0.0%	15	8.3%	17	2.9%
男女合計	0	0.0%	1	1.2%	0	0.0%	1	0.7%	1	0.6%	0	0.0%	2	1.5%	30	8.5%	35	3.1%
無回答																		
男性	2	6.9%	1	2.6%	3	5.2%	4	5.6%	4	5.1%	2	3.6%	2	3.1%	8	4.7%	26	4.6%
女性	1	4.3%	2	4.4%	2	4.4%	3	4.4%	2	2.0%	0	0.0%	5	7.6%	8	4.4%	23	4.0%
男女合計	3	5.8%	3	3.6%	5	4.9%	7	5.0%	6	3.4%	2	1.9%	7	5.4%	16	4.6%	49	4.3%
全体(人)																		
男性	29		38		58		71		79		56		64		170		565	
女性	23		45		45		68		100		50		66		181		578	
男女合計	52		83		103		139		179		106		130		351		1143	

県 中

	10	割合	20	割合	30	割合	40	割合	50	割合	64	割合	69	割合	70～	割合	全体数	割合
1と回答																		
男性	0	0.0%	0	0.0%	0	0.0%	2	2.8%	3	4.4%	0	0.0%	0	0.0%	0	0.0%	5	1.1%
女性	1	4.8%	2	6.3%	0	0.0%	3	4.3%	4	4.7%	0	0.0%	1	1.5%	3	2.8%	14	3.0%
男女合計	1	2.7%	2	3.6%	0	0.0%	5	3.5%	7	4.6%	0	0.0%	1	0.8%	3	1.4%	19	2.1%
2と回答																		
男性	2	12.5%	3	12.5%	13	24.1%	17	23.9%	12	17.6%	6	13.6%	8	14.0%	16	14.5%	77	17.3%
女性	3	14.3%	5	15.6%	6	12.8%	20	28.6%	20	23.5%	11	23.4%	10	15.2%	9	8.5%	84	17.7%
男女合計	5	13.5%	8	14.3%	19	18.8%	37	26.2%	32	20.9%	17	18.7%	18	14.6%	25	11.6%	161	17.5%
3と回答																		
男性	8	50.0%	8	33.3%	26	48.1%	26	36.6%	27	39.7%	19	43.2%	17	29.8%	18	16.4%	149	33.6%
女性	8	38.1%	9	28.1%	22	46.8%	25	35.7%	34	40.0%	17	36.2%	18	27.3%	24	22.6%	157	33.1%
男女合計	16	43.2%	17	30.4%	48	47.5%	51	36.2%	61	39.9%	36	39.6%	35	28.5%	42	19.4%	306	33.3%
4と回答																		
男性	4	25.0%	8	33.3%	13	24.1%	21	29.6%	17	25.0%	12	27.3%	19	33.3%	37	33.6%	131	29.5%
女性	7	33.3%	12	37.5%	12	25.5%	17	24.3%	21	24.7%	13	27.7%	24	36.4%	34	32.1%	140	29.5%
男女合計	11	29.7%	20	35.7%	25	24.8%	38	27.0%	38	24.8%	25	27.5%	43	35.0%	71	32.9%	271	29.5%
5と回答																		
男性	1	6.3%	4	16.7%	1	1.9%	5	7.0%	7	10.3%	5	11.4%	11	19.3%	27	24.5%	61	13.7%
女性	2	9.5%	3	9.4%	7	14.9%	4	5.7%	2	2.4%	5	10.6%	9	13.6%	19	17.9%	51	10.8%
男女合計	3	8.1%	7	12.5%	8	7.9%	9	6.4%	9	5.9%	10	11.0%	20	16.3%	46	21.3%	112	12.2%
6と回答																		
男性	0	0.0%	0	0.0%	0	0.0%	0	0.0%	1	1.5%	1	2.3%	0	0.0%	7	6.4%	9	2.0%
女性	0	0.0%	1	3.1%	0	0.0%	1	1.4%	2	2.4%	0	0.0%	1	1.5%	10	9.4%	15	3.2%
男女合計	0	0.0%	1	1.8%	0	0.0%	1	0.7%	3	2.0%	1	1.1%	1	0.8%	17	7.9%	24	2.6%
無回答																		
男性	1	6.3%	1	4.2%	1	1.9%	0	0.0%	1	1.5%	1	2.3%	2	3.5%	5	4.5%	12	2.7%
女性	0	0.0%	0	0.0%	0	0.0%	0	0.0%	2	2.4%	1	2.1%	3	4.5%	7	6.6%	13	2.7%
男女合計	1	2.7%	1	1.8%	1	1.0%	0	0.0%	3	2.0%	2	2.2%	5	4.1%	12	5.6%	25	2.7%
全体(人)																		
男性	16		24		54		71		68		44		57		110		444	
女性	21		32		47		70		85		47		66		106		474	
男女合計	37		56		101		141		153		91		123		216		918	

県 南

	10	割合	20	割合	30	割合	40	割合	50	割合	64	割合	69	割合	70～	割合	全体数	割合
1と回答																		
男性	0	0.0%	0	0.0%	0	0.0%	4	19.0%	0	0.0%	0	0.0%	0	0.0%	1	1.6%	5	2.7%
女性	0	0.0%	0	0.0%	1	10.0%	5	23.8%	0	0.0%	0	0.0%	0	0.0%	4	5.8%	10	5.3%
男女合計	0	0.0%	0	0.0%	1	4.5%	9	21.4%	0	0.0%	0	0.0%	0	0.0%	5	3.8%	15	4.0%
2と回答																		
男性	1	100.0%	4	30.8%	3	25.0%	4	19.0%	6	20.7%	6	28.6%	2	8.0%	4	6.5%	30	16.3%
女性	0	0.0%	1	25.0%	3	30.0%	4	19.0%	7	25.0%	5	20.0%	4	15.4%	12	17.4%	36	19.3%
男女合計	1	20.0%	5	29.4%	6	27.3%	8	19.0%	13	22.8%	11	23.9%	6	11.8%	16	12.2%	66	17.8%
3と回答																		
男性	0	0.0%	5	38.5%	5	41.7%	7	33.3%	7	24.1%	8	38.1%	8	32.0%	20	32.3%	60	32.6%
女性	0	0.0%	2	50.0%	4	40.0%	8	38.1%	11	39.3%	8	32.0%	10	38.5%	13	18.8%	56	29.9%
男女合計	0	0.0%	7	41.2%	9	40.9%	15	35.7%	18	31.6%	16	34.8%	18	35.3%	33	25.2%	116	31.3%
4と回答																		
男性	0	0.0%	4	30.8%	4	33.3%	4	19.0%	10	34.5%	5	23.8%	9	36.0%	14	22.6%	50	27.2%
女性	3	75.0%	1	25.0														

会 津

	10	割合	20	割合	30	割合	40	割合	50	割合	64	割合	69	割合	70～	割合	全体数	割合
1と回答	0	0.0%	0	0.0%	0	0.0%	0	0.0%	1	3.1%	0	0.0%	1	3.0%	3	2.5%	5	1.7%
男性	0	0.0%	0	0.0%	0	0.0%	0	0.0%	1	3.1%	0	0.0%	1	3.0%	3	2.5%	5	1.7%
女性	1	20.0%	0	0.0%	0	0.0%	2	7.4%	1	2.7%	0	0.0%	1	3.1%	2	1.5%	7	2.3%
男女合計	1	5.9%	0	0.0%	0	0.0%	2	3.8%	2	2.9%	0	0.0%	2	3.1%	5	2.0%	12	2.0%
2と回答	3	25.0%	3	23.1%	3	15.0%	4	16.0%	4	12.5%	7	20.0%	4	12.1%	18	15.1%	46	15.9%
男性	1	20.0%	2	14.3%	5	22.7%	10	37.0%	12	32.4%	6	18.8%	5	15.6%	15	11.5%	56	18.7%
女性	2	40.0%	1	7.1%	1	3.5%	2	7.1%	2	5.4%	1	2.7%	1	2.7%	3	2.3%	11	3.5%
男女合計	4	23.5%	5	18.5%	8	19.0%	14	26.9%	16	23.2%	13	19.4%	9	13.8%	33	13.3%	102	17.3%
3と回答	6	50.0%	4	30.8%	7	35.0%	10	40.0%	15	46.9%	15	42.9%	7	21.2%	31	26.1%	95	32.9%
男性	0	0.0%	8	57.1%	9	40.9%	8	29.6%	13	35.1%	15	46.9%	11	34.4%	34	26.2%	98	32.8%
女性	6	35.3%	12	44.4%	16	38.1%	18	34.6%	28	40.6%	30	44.8%	18	27.7%	65	26.1%	193	32.8%
男女合計	6	35.3%	12	44.4%	16	38.1%	18	34.6%	28	40.6%	30	44.8%	18	27.7%	65	26.1%	193	32.8%
4と回答	2	16.7%	6	46.2%	4	20.0%	4	16.0%	8	25.0%	8	22.9%	7	21.2%	24	20.2%	63	21.8%
男性	2	40.0%	3	21.4%	6	27.3%	4	14.8%	6	16.2%	4	12.5%	9	28.1%	35	26.9%	69	23.1%
女性	2	40.0%	9	33.3%	10	23.8%	8	15.4%	14	20.3%	12	17.9%	16	24.6%	59	23.7%	132	22.4%
男女合計	4	23.5%	9	33.3%	10	23.8%	8	15.4%	14	20.3%	12	17.9%	16	24.6%	59	23.7%	132	22.4%
5と回答	0	0.0%	0	0.0%	3	15.0%	5	20.0%	3	9.4%	4	11.4%	12	36.4%	28	23.5%	55	19.0%
男性	1	20.0%	0	0.0%	2	9.1%	2	7.4%	2	5.4%	6	18.8%	5	15.6%	27	20.8%	45	15.1%
女性	0	0.0%	0	0.0%	1	3.5%	3	12.7%	1	2.7%	2	5.4%	7	21.2%	1	0.8%	10	3.5%
男女合計	1	5.9%	0	0.0%	5	11.9%	7	13.5%	5	7.2%	10	14.9%	17	26.2%	55	22.1%	100	17.0%
6と回答	0	0.0%	0	0.0%	0	0.0%	1	4.0%	0	0.0%	0	0.0%	1	3.0%	8	6.7%	10	3.5%
男性	0	0.0%	0	0.0%	0	0.0%	0	0.0%	0	0.0%	0	0.0%	0	0.0%	11	8.5%	11	3.7%
女性	0	0.0%	0	0.0%	0	0.0%	1	1.9%	0	0.0%	0	0.0%	1	1.5%	19	7.6%	21	3.6%
男女合計	0	0.0%	0	0.0%	0	0.0%	1	1.9%	0	0.0%	0	0.0%	1	1.5%	19	7.6%	21	3.6%
無回答	1	8.3%	0	0.0%	3	15.0%	1	4.0%	1	3.1%	1	2.9%	1	3.0%	7	5.9%	15	5.2%
男性	0	0.0%	1	7.1%	0	0.0%	1	3.7%	3	8.1%	1	3.1%	1	3.1%	6	4.6%	13	4.3%
女性	1	5.9%	1	3.7%	3	7.1%	2	3.8%	4	5.8%	2	3.0%	2	3.1%	13	5.2%	28	4.8%
男女合計	1	5.9%	1	3.7%	3	7.1%	2	3.8%	4	5.8%	2	3.0%	2	3.1%	13	5.2%	28	4.8%
全体(人)	12		13		20		25		32		35		33		119		289	
男性	5		14		22		27		37		32		32		130		299	
女性	7		27		42		52		69		67		65		249		588	
男女合計	17		27		42		52		69		67		65		249		588	

南 会 津

	10	割合	20	割合	30	割合	40	割合	50	割合	64	割合	69	割合	70～	割合	全体数	割合
1と回答	0	0.0%	0	0.0%	0	0.0%	0	0.0%	0	0.0%	0	0.0%	0	0.0%	0	0.0%	0	0.0%
男性	1	33.3%	0	0.0%	1	100.0%	0	0.0%	0	0.0%	0	0.0%	1	16.7%	0	0.0%	3	8.6%
女性	1	20.0%	0	0.0%	1	50.0%	0	0.0%	0	0.0%	0	0.0%	1	10.0%	0	0.0%	3	4.1%
男女合計	1	20.0%	0	0.0%	1	50.0%	0	0.0%	0	0.0%	0	0.0%	1	10.0%	0	0.0%	3	4.1%
2と回答	1	50.0%	0	0.0%	0	0.0%	1	33.3%	0	0.0%	1	33.3%	0	0.0%	0	0.0%	3	7.9%
男性	0	0.0%	0	0.0%	0	0.0%	1	20.0%	0	0.0%	0	0.0%	2	33.3%	1	6.7%	4	11.4%
女性	1	20.0%	0	0.0%	0	0.0%	2	25.0%	0	0.0%	1	20.0%	2	20.0%	1	2.9%	7	9.6%
男女合計	1	20.0%	0	0.0%	0	0.0%	2	25.0%	0	0.0%	1	20.0%	2	20.0%	1	2.9%	7	9.6%
3と回答	1	50.0%	2	100.0%	1	100.0%	0	0.0%	0	0.0%	2	66.7%	2	50.0%	5	25.0%	13	34.2%
男性	1	33.3%	0	0.0%	0	0.0%	3	60.0%	1	33.3%	1	33.3%	1	16.7%	3	20.0%	10	28.6%
女性	2	40.0%	2	100.0%	1	50.0%	3	37.5%	1	16.7%	3	60.0%	3	30.0%	8	22.9%	23	31.5%
男女合計	2	40.0%	2	100.0%	1	50.0%	3	37.5%	1	16.7%	3	60.0%	3	30.0%	8	22.9%	23	31.5%
4と回答	0	0.0%	0	0.0%	0	0.0%	1	33.3%	3	100.0%	0	0.0%	2	50.0%	2	10.0%	8	21.1%
男性	1	33.3%	0	0.0%	0	0.0%	1	20.0%	0	0.0%	0	0.0%	1	16.7%	3	20.0%	6	17.1%
女性	1	20.0%	0	0.0%	0	0.0%	2	25.0%	3	50.0%	0	0.0%	3	30.0%	5	14.3%	14	19.2%
男女合計	1	20.0%	0	0.0%	0	0.0%	2	25.0%	3	50.0%	0	0.0%	3	30.0%	5	14.3%	14	19.2%
5と回答	0	0.0%	0	0.0%	0	0.0%	1	33.3%	0	0.0%	0	0.0%	0	0.0%	10	50.0%	11	28.9%
男性	0	0.0%	0	0.0%	0	0.0%	0	0.0%	1	33.3%	1	50.0%	1	16.7%	6	40.0%	9	25.7%
女性	0	0.0%	0	0.0%	0	0.0%	1	12.5%	1	16.7%	1	20.0%	1	10.0%	16	45.7%	20	27.4%
男女合計	0	0.0%	0	0.0%	0	0.0%	1	12.5%	1	16.7%	1	20.0%	1	10.0%	16	45.7%	20	27.4%
6と回答	0	0.0%	0	0.0%	0	0.0%	0	0.0%	0	0.0%	0	0.0%	0	0.0%	2	10.0%	2	5.3%
男性	0	0.0%	0	0.0%	0	0.0%	0	0.0%	0	0.0%	0	0.0%	0	0.0%	0	0.0%	1	2.9%
女性	0	0.0%	0	0.0%	0	0.0%	0	0.0%	0	0.0%	0	0.0%	0	0.0%	3	8.6%	3	4.1%
男女合計	0	0.0%	0	0.0%	0	0.0%	0	0.0%	0	0.0%	0	0.0%	0	0.0%	3	8.6%	3	4.1%
無回答	0	0.0%	0	0.0%	0	0.0%	0	0.0%	0	0.0%	0	0.0%	0	0.0%	1	5.0%	1	2.6%
男性	0	0.0%	0	0.0%	0	0.0%	0	0.0%	1	33.3%	0	0.0%	0	0.0%	1	6.7%	2	5.7%
女性	0	0.0%	0	0.0%	0	0.0%	0	0.0%	1	16.7%	0	0.0%	0	0.0%	2	5.7%	3	4.1%
男女合計	0	0.0%	0	0.0%	0	0.0%	0	0.0%	1	16.7%	0	0.0%	0	0.0%	2	5.7%	3	4.1%
全体(人)	2		2		1		3		3		3		4		20		38	
男性	3		0		1		5		3		2		6		15		35	
女性	3		2		2		8		6		5		10		35		73	
男女合計	5		2		2		8		6		5		10		35		73	

相 双

	10	割合	20	割合	30	割合	40	割合	50	割合	64	割合	69	割合	70～	割合	全体数	割合
1と回答	0	0.0%	0	0.0%	0	0.0%	0	0.0%	0	0.0%	0	0.0%	0	0.0%	1	2.6%	1	0.8%
男性	0	0.0%	0	0.0%	0	0.0%	2	18.2%	1	4.8%	0	0.0%	1	4.3%	0	0.0%	4	3.0%
女性	0	0.0%	0	0.0%	0	0.0%	2	10.5%	1	3.0%	0	0.0%	1	2.1%	1	1.1%	5	2.0%
男女合計	0	0.0%	0	0.0%	0	0.0%	2	10.5%	1	3.0%	0	0.0%	1	2.1%	1	1.1%	5	2.0%
2と回答	1	25.0%	1	11.1%	2	20.0%	4	50.0%	3	25.0%	5	38.5%	3	12.0%	1	2.6%	20	16.7%
男性	0	0.0%	1	20.0%	2	25.0%	2	18.2%	4	19.0%	2	13.3%	2	8.7%	4	8.3%	17	12.9%
女性	1	20.0%	2	14.3%	4	22.2%	6	31.6%	7	21.2%	7	25.0%	5	10.4%	5	5.7%	37	14.7%
男女合計	1	20.0%	2	14.3%	4	22.2%	6	31.6%	7	21.2%	7	25.0%	5	10.4%	5	5.7%	37	14.7%
3と回答	2	50.0%	4	44.4%	4	40.0%	1	12.5%	7	58.3%	5							

いわき

	10	割合	20	割合	30	割合	40	割合	50	割合	64	割合	69	割合	70～	割合	全体数	割合
1と回答	0	0.0%	1	4.8%	1	2.0%	1	1.9%	0	0.0%	0	0.0%	0	0.0%	3	3.0%	6	1.7%
男性	1	9.1%	0	0.0%	0	0.0%	1	1.9%	2	3.5%	1	3.1%	0	0.0%	2	1.7%	7	1.9%
女性	1	4.3%	1	2.3%	1	1.1%	2	1.9%	2	1.9%	1	1.8%	0	0.0%	5	2.3%	13	1.8%
男女合計	1	4.3%	1	2.3%	1	1.1%	2	1.9%	2	1.9%	1	1.8%	0	0.0%	5	2.3%	13	1.8%
2と回答	4	33.3%	5	23.8%	13	25.5%	16	29.6%	13	26.5%	5	20.0%	7	18.9%	5	5.1%	68	19.5%
男性	2	18.2%	3	13.6%	6	15.0%	12	22.2%	12	21.1%	10	31.3%	2	5.6%	16	13.2%	63	16.9%
女性	2	18.2%	3	13.6%	6	15.0%	12	22.2%	12	21.1%	10	31.3%	2	5.6%	16	13.2%	63	16.9%
男女合計	6	26.1%	8	18.6%	19	20.9%	28	25.9%	25	23.6%	15	26.3%	9	12.3%	21	9.5%	131	18.2%
3と回答	5	41.7%	2	9.5%	25	49.0%	19	35.2%	13	26.5%	4	16.0%	11	29.7%	36	36.4%	115	33.0%
男性	6	54.5%	11	50.0%	16	40.0%	22	40.7%	25	43.9%	12	37.5%	16	44.4%	37	30.6%	145	38.9%
女性	6	54.5%	11	50.0%	16	40.0%	22	40.7%	25	43.9%	12	37.5%	16	44.4%	37	30.6%	145	38.9%
男女合計	11	47.8%	13	30.2%	41	45.1%	41	38.0%	38	35.8%	16	28.1%	27	37.0%	73	33.2%	260	36.1%
4と回答	1	8.3%	9	42.9%	9	17.6%	11	20.4%	17	34.7%	11	44.0%	13	35.1%	21	21.2%	92	26.4%
男性	0	0.0%	3	13.6%	11	27.5%	13	24.1%	12	21.1%	7	21.9%	12	33.3%	34	28.1%	92	24.7%
女性	1	4.3%	12	27.9%	20	22.0%	24	22.2%	29	27.4%	18	31.6%	25	34.2%	55	25.0%	184	25.5%
男女合計	1	4.3%	12	27.9%	20	22.0%	24	22.2%	29	27.4%	18	31.6%	25	34.2%	55	25.0%	184	25.5%
5と回答	0	0.0%	2	9.5%	2	3.9%	5	9.3%	3	6.1%	5	20.0%	5	13.5%	28	28.3%	50	14.4%
男性	2	18.2%	3	13.6%	7	17.5%	4	7.4%	5	8.8%	2	6.3%	4	11.1%	21	17.4%	48	12.9%
女性	2	18.2%	3	13.6%	7	17.5%	4	7.4%	5	8.8%	2	6.3%	4	11.1%	21	17.4%	48	12.9%
男女合計	2	8.7%	5	11.6%	9	9.9%	9	8.3%	8	7.5%	7	12.3%	9	12.3%	49	22.3%	98	13.6%
6と回答	2	16.7%	0	0.0%	0	0.0%	1	1.9%	1	2.0%	0	0.0%	1	2.7%	3	3.0%	8	2.3%
男性	0	0.0%	0	0.0%	0	0.0%	0	0.0%	0	0.0%	0	0.0%	1	2.8%	8	6.6%	9	2.4%
女性	2	16.7%	0	0.0%	0	0.0%	1	1.9%	1	2.0%	0	0.0%	1	2.7%	3	3.0%	8	2.3%
男女合計	2	8.7%	0	0.0%	0	0.0%	1	0.9%	1	0.9%	0	0.0%	2	2.7%	11	5.0%	17	2.4%
無回答	0	0.0%	2	9.5%	1	2.0%	1	1.9%	2	4.1%	0	0.0%	0	0.0%	3	3.0%	9	2.6%
男性	0	0.0%	2	9.1%	0	0.0%	2	3.7%	1	1.8%	0	0.0%	1	2.8%	3	2.5%	9	2.4%
女性	0	0.0%	4	9.3%	1	1.1%	3	2.8%	3	2.8%	0	0.0%	1	1.4%	6	2.7%	18	2.5%
男女合計	0	0.0%	4	9.3%	1	1.1%	3	2.8%	3	2.8%	0	0.0%	1	1.4%	6	2.7%	18	2.5%
全体(人)	12		21		51		54		49		25		37		99		348	
男性	11		22		40		54		57		32		36		121		373	
女性	11		22		40		54		57		32		36		121		373	
男女合計	23		43		91		108		106		57		73		220		721	

全県(60歳以上・再掲)

	64	割合	69	割合	70	割合	80	割合	90	割合	全体数	割合
1と回答	3	1.5%	1	0.4%	7	1.8%	1	0.5%	1	5.6%	13	1.2%
男性	2	1.0%	4	1.6%	8	2.2%	6	2.4%	0	0.0%	20	1.8%
女性	5	1.3%	5	1.0%	15	2.0%	7	1.5%	1	1.4%	33	1.5%
男女合計	5	1.3%	5	1.0%	15	2.0%	7	1.5%	1	1.4%	33	1.5%
2と回答	40	20.3%	29	11.8%	45	11.3%	17	8.4%	1	5.6%	132	12.4%
男性	43	21.2%	36	14.1%	57	15.5%	26	10.4%	3	5.7%	165	14.6%
女性	43	21.2%	36	14.1%	57	15.5%	26	10.4%	3	5.7%	165	14.6%
男女合計	83	20.8%	65	13.0%	102	13.3%	43	9.5%	4	5.6%	297	13.6%
3と回答	73	37.1%	74	30.2%	114	28.6%	41	20.2%	4	22.2%	306	28.8%
男性	82	40.4%	82	32.2%	121	32.9%	49	19.7%	3	5.7%	337	29.9%
女性	82	40.4%	82	32.2%	121	32.9%	49	19.7%	3	5.7%	337	29.9%
男女合計	155	38.8%	156	31.2%	235	30.7%	90	19.9%	7	9.9%	643	29.4%
4と回答	53	26.9%	83	33.9%	105	26.4%	49	24.1%	2	11.1%	292	27.5%
男性	52	25.6%	90	35.3%	118	32.1%	59	23.7%	11	20.8%	330	29.3%
女性	52	25.6%	90	35.3%	118	32.1%	59	23.7%	11	20.8%	330	29.3%
男女合計	105	26.3%	173	34.6%	223	29.1%	108	23.9%	13	18.3%	622	28.4%
5と回答	23	11.7%	48	19.6%	93	23.4%	66	32.5%	6	33.3%	236	22.2%
男性	21	10.3%	31	12.2%	47	12.8%	65	26.1%	17	32.1%	181	16.0%
女性	21	10.3%	31	12.2%	47	12.8%	65	26.1%	17	32.1%	181	16.0%
男女合計	44	11.0%	79	15.8%	140	18.3%	131	29.0%	23	32.4%	417	19.0%
6と回答	1	0.5%	4	1.6%	21	5.3%	18	8.9%	3	16.7%	47	4.4%
男性	1	0.5%	2	0.8%	5	1.4%	31	12.4%	12	22.6%	51	4.5%
女性	1	0.5%	2	0.8%	5	1.4%	31	12.4%	12	22.6%	51	4.5%
男女合計	2	0.5%	6	1.2%	26	3.4%	49	10.8%	15	21.1%	98	4.5%
無回答	4	2.0%	6	2.4%	13	3.3%	11	5.4%	1	5.6%	35	3.3%
男性	2	1.0%	10	3.9%	12	3.3%	13	5.2%	7	13.2%	44	3.9%
女性	2	1.0%	10	3.9%	12	3.3%	13	5.2%	7	13.2%	44	3.9%
男女合計	6	1.5%	16	3.2%	25	3.3%	24	5.3%	8	11.3%	79	3.6%
全体(人)	197		245		398		203		18		1061	
男性	203		255		368		249		53		1128	
女性	203		255		368		249		53		1128	
男女合計	400		500		766		452		71		2189	

24 疲労の状況（満15歳以上対象）（調査票 問24）

問24 疲れすぎたと感じていますか。あてはまる番号を1つ選んで○をつけてください。

1 感じている 2 あまり感じていない 3 まったく感じていない

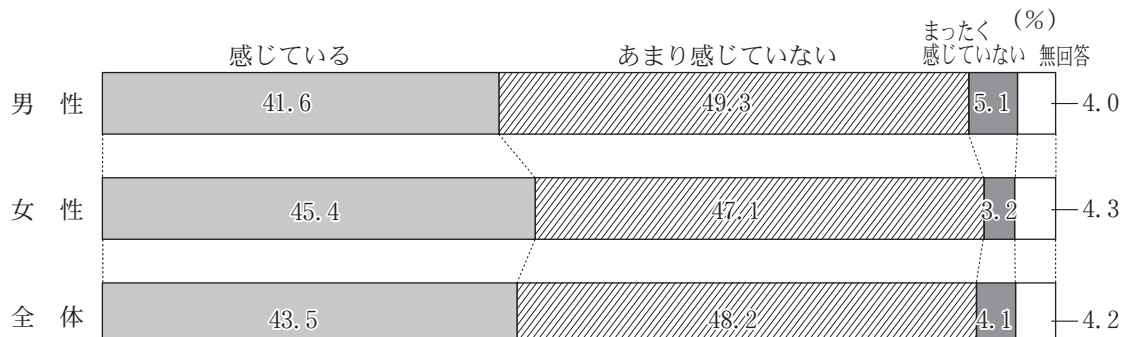

	10	割合	20	割合	30	割合	40	割合	50	割合	64	割合	69	割合	70	割合	80	割合	90	割合	全体数	割合
1と回答																						
男性	25	32.9%	46	38.3%	106	51.5%	128	50.6%	144	52.9%	99	50.3%	78	31.8%	114	28.6%	77	37.9%	10	55.6%	827	41.6%
女性	21	30.9%	60	49.2%	92	53.2%	147	57.4%	182	55.0%	88	43.3%	92	36.1%	137	37.2%	108	43.4%	16	30.2%	943	45.4%
男女合計	46	31.9%	106	43.8%	198	52.2%	275	54.0%	326	54.1%	187	46.8%	170	34.0%	251	32.8%	185	40.9%	26	36.6%	1770	43.5%
2と回答																						
男性	34	44.7%	58	48.3%	90	43.7%	110	43.5%	110	40.4%	87	44.2%	141	57.6%	247	62.1%	98	48.3%	6	33.3%	981	49.3%
女性	40	58.8%	53	43.4%	75	43.4%	98	38.3%	131	39.6%	101	49.8%	145	56.9%	206	56.0%	104	41.8%	25	47.2%	978	47.1%
男女合計	74	51.4%	111	45.9%	165	43.5%	208	40.9%	241	40.0%	188	47.0%	286	57.2%	453	59.1%	202	44.7%	31	43.7%	1959	48.2%
3と回答																						
男性	13	17.1%	12	10.0%	5	2.4%	6	2.4%	10	3.7%	3	1.5%	15	6.1%	23	5.8%	13	6.4%	1	5.6%	101	5.1%
女性	6	8.8%	4	3.3%	4	2.3%	3	1.2%	7	2.1%	9	4.4%	8	3.1%	11	3.0%	12	4.8%	3	5.7%	67	3.2%
男女合計	19	13.2%	16	6.6%	9	2.4%	9	1.8%	17	2.8%	12	3.0%	23	4.6%	34	4.4%	25	5.5%	4	5.6%	168	4.1%
無回答																						
男性	4	5.3%	4	3.3%	5	2.4%	9	3.6%	8	2.9%	8	4.1%	11	4.5%	14	3.5%	15	7.4%	1	5.6%	79	4.0%
女性	1	1.5%	5	4.1%	2	1.2%	8	3.1%	11	3.3%	5	2.5%	10	3.9%	14	3.8%	25	10.0%	9	17.0%	90	4.3%
男女合計	5	3.5%	9	3.7%	7	1.8%	17	3.3%	19	3.2%	13	3.3%	21	4.2%	28	3.7%	40	8.8%	10	14.1%	169	4.2%
全体(人)																						
男性	76		120		206		253		272		197		245		398		203		18		1988	
女性	68		122		173		256		331		203		255		368		249		53		2078	
男女合計	144		242		379		509		603		400		500		766		452		71		4066	

県 北

	10	割合	20	割合	30	割合	40	割合	50	割合	64	割合	69	割合	70～	割合	全体数	割合
1と回答	9	31.0%	15	39.5%	31	53.4%	40	56.3%	43	54.4%	27	48.2%	15	23.4%	46	27.1%	226	40.0%
男性	5	21.7%	17	37.8%	26	57.8%	40	58.8%	56	56.0%	25	50.0%	21	31.8%	68	37.6%	258	44.6%
女性	14	26.9%	32	38.6%	57	55.3%	80	57.6%	99	55.3%	52	49.1%	36	27.7%	114	32.5%	484	42.3%
男女合計	14	26.9%	32	38.6%	57	55.3%	80	57.6%	99	55.3%	52	49.1%	36	27.7%	114	32.5%	484	42.3%
2と回答	14	48.3%	19	50.0%	24	41.4%	26	36.6%	29	36.7%	26	46.4%	41	64.1%	111	65.3%	290	51.3%
男性	14	60.9%	23	51.1%	17	37.8%	23	33.8%	38	38.0%	24	48.0%	39	59.1%	98	54.1%	276	47.8%
女性	28	53.8%	42	50.6%	41	39.8%	49	35.3%	67	37.4%	50	47.2%	80	61.5%	209	59.5%	566	49.5%
男女合計	28	53.8%	42	50.6%	41	39.8%	49	35.3%	67	37.4%	50	47.2%	80	61.5%	209	59.5%	566	49.5%
3と回答	4	13.8%	3	7.9%	1	1.7%	1	1.4%	3	3.8%	1	1.8%	3	4.7%	7	4.1%	23	4.1%
男性	3	13.0%	3	6.7%	0	0.0%	2	2.9%	3	3.0%	0	0.0%	2	3.0%	4	2.2%	17	2.9%
女性	7	13.5%	6	7.2%	1	1.0%	3	2.2%	6	3.4%	1	0.9%	5	3.8%	11	3.1%	40	3.5%
男女合計	7	13.5%	6	7.2%	1	1.0%	3	2.2%	6	3.4%	1	0.9%	5	3.8%	11	3.1%	40	3.5%
無回答	2	6.9%	1	2.6%	2	3.4%	4	5.6%	4	5.1%	2	3.6%	5	7.8%	6	3.5%	26	4.6%
男性	1	4.3%	2	4.4%	2	4.4%	3	4.4%	3	3.0%	1	2.0%	4	6.1%	11	6.1%	27	4.7%
女性	3	5.8%	3	3.6%	4	3.9%	7	5.0%	7	3.9%	3	2.8%	9	6.9%	17	4.8%	53	4.6%
男女合計	3	5.8%	3	3.6%	4	3.9%	7	5.0%	7	3.9%	3	2.8%	9	6.9%	17	4.8%	53	4.6%
全体(人)	29		38		58		71		79		56		64		170		565	
男性	23		45		45		68		100		50		66		181		578	
女性	52		83		103		139		179		106		130		351		1143	
男女合計	52		83		103		139		179		106		130		351		1143	

県 中

	10	割合	20	割合	30	割合	40	割合	50	割合	64	割合	69	割合	70～	割合	全体数	割合
1と回答	5	31.3%	10	41.7%	28	51.9%	34	47.9%	34	50.0%	26	59.1%	20	35.1%	40	36.4%	197	44.4%
男性	6	28.6%	20	62.5%	23	48.9%	40	57.1%	53	62.4%	21	44.7%	29	43.9%	37	34.9%	229	48.3%
女性	11	29.7%	30	53.6%	51	50.5%	74	52.5%	87	56.9%	47	51.6%	49	39.8%	77	35.6%	426	46.4%
男女合計	11	29.7%	30	53.6%	51	50.5%	74	52.5%	87	56.9%	47	51.6%	49	39.8%	77	35.6%	426	46.4%
2と回答	7	43.8%	9	37.5%	26	48.1%	36	50.7%	30	44.1%	17	38.6%	32	56.1%	60	54.5%	217	48.9%
男性	14	66.7%	12	37.5%	23	48.9%	29	41.4%	29	34.1%	21	44.7%	32	48.5%	54	50.9%	214	45.1%
女性	21	56.8%	21	37.5%	49	48.5%	65	46.1%	59	38.6%	38	41.8%	64	52.0%	114	52.8%	431	46.9%
男女合計	21	56.8%	21	37.5%	49	48.5%	65	46.1%	59	38.6%	38	41.8%	64	52.0%	114	52.8%	431	46.9%
3と回答	3	18.8%	4	16.7%	0	0.0%	1	1.4%	3	4.4%	0	0.0%	3	5.3%	3	2.7%	17	3.8%
男性	1	4.8%	0	0.0%	1	2.1%	0	0.0%	1	1.2%	4	8.5%	3	4.5%	3	2.8%	13	2.7%
女性	4	10.8%	4	7.1%	1	1.0%	1	0.7%	4	2.6%	4	4.4%	6	4.9%	6	2.8%	30	3.3%
男女合計	4	10.8%	4	7.1%	1	1.0%	1	0.7%	4	2.6%	4	4.4%	6	4.9%	6	2.8%	30	3.3%
無回答	1	6.3%	1	4.2%	0	0.0%	0	0.0%	1	1.5%	1	2.3%	2	3.5%	7	6.4%	13	2.9%
男性	0	0.0%	0	0.0%	0	0.0%	1	1.4%	2	2.4%	1	2.1%	2	3.0%	12	11.3%	18	3.8%
女性	1	2.7%	1	1.8%	0	0.0%	1	0.7%	3	2.0%	2	2.2%	4	3.3%	19	8.8%	31	3.4%
男女合計	1	2.7%	1	1.8%	0	0.0%	1	0.7%	3	2.0%	2	2.2%	4	3.3%	19	8.8%	31	3.4%
全体(人)	16		24		54		71		68		44		57		110		444	
男性	21		32		47		70		85		47		66		106		474	
女性	37		56		101		141		153		91		123		216		918	
男女合計	37		56		101		141		153		91		123		216		918	

県 南

	10	割合	20	割合	30	割合	40	割合	50	割合	64	割合	69	割合	70～	割合	全体数	割合
1と回答	1	100.0%	8	61.5%	6	50.0%	8	38.1%	17	58.6%	11	52.4%	10	40.0%	21	33.9%	82	44.6%
男性	1	25.0%	4	100.0%	6	60.0%	13	61.9%	17	60.7%	9	36.0%	8	30.8%	23	33.3%	81	43.3%
女性	2	40.0%	12	70.6%	12	54.5%	21	50.0%	34	59.6%	20	43.5%	18	35.3%	44	33.6%	163	43.9%
男女合計	2	40.0%	12	70.6%	12	54.5%	21	50.0%	34	59.6%	20	43.5%	18	35.3%	44	33.6%	163	43.9%
2と回答	0	0.0%	3	23.1%	5	41.7%	11	52.4%	11	37.9%	9	42.9%	13	52.0%	33	53.2%	85	46.2%
男性	3	75.0%	0	0.0%	4	40.0%	8	38.1%	10	35.7%	14	56.0%	15	57.7%	38	55.1%	92	49.2%
女性	3	60.0%	3	17.6%	9	40.9%	19	45.2%	21	36.8%	23	50.0%	28	54.9%	71	54.2%	177	47.7%
男女合計	3	60.0%	3	17.6%	9	40.9%	19	45.2%	21	36.8%	23	50.0%	28	54.9%	71	54.2%	177	47.7%
3と回答	0	0.0%	2	15.4%	1	8.3%	1	4.8%	1	3.4%	0	0.0%	2	8.0%	7	11.3%	14	7.6%
男性	0	0.0%	0	0.0%	0	0.0%	0	0.0%	0	0.0%	2	8.0%	2	7.7%	3	4.3%	7	3.7%
女性	0	0.0%	2	11.8%	1	4.5%	1	2.4%	1	1.8%	2	4.3%	4	7.8%	10	7.6%	21	5.7%
男女合計	0	0.0%	2	11.8%	1	4.5%	1	2.4%	1	1.8%	2	4.3%	4	7.8%	10	7.6%	21	5.7%
無回答	0	0.0%	0	0.0%	0	0.0%	1	4.8%	0	0.0%	1	4.8%	0	0.0%	1	1.6%	3	1.6%
男性	0	0.0%	0	0.0%	0	0.0%	0	0.0%	1	3.6%	0	0.0%	1	3.8%	5	7.2%	7	3.7%
女性	0	0.0%	0	0.0%	0	0.0%	1	2.4%	1	1.8%	1	2.2%	1	2.0%	6	4.6%	10	2.7%
男女合計	0	0.0%	0	0.0%	0	0.0%	1	2.4%	1	1.8%	1	2.2%	1	2.0%	6	4.6%	10	2.7%
全体(人)	1		13		12		21		29		21		25		62		184	
男性	4		4		10		21		28		25		26		69		187	
女性	5		17		22		42		57		46		51		131		371	
男女合計	5		17		22		42		57		46		51		131		371	

会 津

	10	割合	20	割合	30	割合	40	割合	50	割合	64	割合	69	割合	70～	割合	全体数	割合
1と回答																		
男性	2	16.7%	5	38.5%	10	50.0%	8	32.0%	17	53.1%	16	45.7%	13	39.4%	44	37.0%	115	39.8%
女性	2	40.0%	4	28.6%	11	50.0%	12	44.4%	16	43.2%	15	46.9%	14	43.8%	54	41.5%	128	42.8%
男女合計	4	23.5%	9	33.3%	21	50.0%	20	38.5%	33	47.8%	31	46.3%	27	41.5%	98	39.4%	243	41.3%
2と回答																		
男性	5	41.7%	7	53.8%	8	40.0%	14	56.0%	13	40.6%	16	45.7%	18	54.5%	58	48.7%	139	48.1%
女性	2	40.0%	9	64.3%	8	36.4%	13	48.1%	18	48.6%	13	40.6%	16	50.0%	58	44.6%	137	45.8%
男女合計	7	41.2%	16	59.3%	16	38.1%	27	51.9%	31	44.9%	29	43.3%	34	52.3%	116	46.6%	276	46.9%
3と回答																		
男性	4	33.3%	1	7.7%	0	0.0%	2	8.0%	1	3.1%	1	2.9%	0	0.0%	8	6.7%	17	5.9%
女性	1	20.0%	0	0.0%	3	13.6%	1	3.7%	1	2.7%	2	6.3%	1	3.1%	8	6.2%	17	5.7%
男女合計	5	29.4%	1	3.7%	3	7.1%	3	5.8%	2	2.9%	3	4.5%	1	1.5%	16	6.4%	34	5.8%
無回答																		
男性	1	8.3%	0	0.0%	2	10.0%	1	4.0%	1	3.1%	2	5.7%	2	6.1%	9	7.6%	18	6.2%
女性	0	0.0%	1	7.1%	0	0.0%	1	3.7%	2	5.4%	2	6.3%	1	3.1%	10	7.7%	17	5.7%
男女合計	1	5.9%	1	3.7%	2	4.8%	2	3.8%	3	4.3%	4	6.0%	3	4.6%	19	7.6%	35	6.0%
全体(人)																		
男性	12		13		20		25		32		35		33		119		289	
女性	5		14		22		27		37		32		32		130		299	
男女合計	17		27		42		52		69		67		65		249		588	

南 会 津

	10	割合	20	割合	30	割合	40	割合	50	割合	64	割合	69	割合	70～	割合	全体数	割合
1と回答																		
男性	2	100.0%	1	50.0%	0	0.0%	2	66.7%	1	33.3%	2	66.7%	1	25.0%	3	15.0%	12	31.6%
女性	2	66.7%	0	0.0%	1	100.0%	4	80.0%	0	0.0%	2	100.0%	3	50.0%	10	66.7%	22	62.9%
男女合計	4	80.0%	1	50.0%	1	50.0%	6	75.0%	1	16.7%	4	80.0%	4	40.0%	13	37.1%	34	46.6%
2と回答																		
男性	0	0.0%	1	50.0%	1	100.0%	1	33.3%	2	66.7%	1	33.3%	2	50.0%	12	60.0%	20	52.6%
女性	1	33.3%	0	0.0%	0	0.0%	1	20.0%	2	66.7%	0	0.0%	3	50.0%	2	13.3%	9	25.7%
男女合計	1	20.0%	1	50.0%	1	50.0%	2	25.0%	4	66.7%	1	20.0%	5	50.0%	14	40.0%	29	39.7%
3と回答																		
男性	0	0.0%	0	0.0%	0	0.0%	0	0.0%	0	0.0%	0	0.0%	0	0.0%	3	15.0%	3	7.9%
女性	0	0.0%	0	0.0%	0	0.0%	0	0.0%	0	0.0%	0	0.0%	0	0.0%	1	6.7%	1	2.9%
男女合計	0	0.0%	0	0.0%	0	0.0%	0	0.0%	0	0.0%	0	0.0%	0	0.0%	4	11.4%	4	5.5%
無回答																		
男性	0	0.0%	0	0.0%	0	0.0%	0	0.0%	0	0.0%	0	0.0%	1	25.0%	2	10.0%	3	7.9%
女性	0	0.0%	0	0.0%	0	0.0%	0	0.0%	1	33.3%	0	0.0%	0	0.0%	2	13.3%	3	8.6%
男女合計	0	0.0%	0	0.0%	0	0.0%	0	0.0%	1	16.7%	0	0.0%	1	10.0%	4	11.4%	6	8.2%
全体(人)																		
男性	2		2		1		3		3		3		4		20		38	
女性	3		0		1		5		3		2		6		15		35	
男女合計	5		2		2		8		6		5		10		35		73	

相 双

	10	割合	20	割合	30	割合	40	割合	50	割合	64	割合	69	割合	70～	割合	全体数	割合
1と回答																		
男性	2	50.0%	3	33.3%	3	30.0%	4	50.0%	6	50.0%	7	53.8%	7	28.0%	12	30.8%	44	36.7%
女性	1	100.0%	4	80.0%	3	37.5%	8	72.7%	9	42.9%	3	20.0%	7	30.4%	23	47.9%	58	43.9%
男女合計	3	60.0%	7	50.0%	6	33.3%	12	63.2%	15	45.5%	10	35.7%	14	29.2%	35	40.2%	102	40.5%
2と回答																		
男性	2	50.0%	6	66.7%	6	60.0%	2	25.0%	6	50.0%	6	46.2%	16	64.0%	21	53.8%	65	54.2%
女性	0	0.0%	1	20.0%	5	62.5%	2	18.2%	11	52.4%	10	66.7%	16	69.6%	22	45.8%	67	50.8%
男女合計	2	40.0%	7	50.0%	11	61.1%	4	21.1%	17	51.5%	16	57.1%	32	66.7%	43	49.4%	132	52.4%
3と回答																		
男性	0	0.0%	0	0.0%	1	10.0%	0	0.0%	0	0.0%	0	0.0%	1	4.0%	5	12.8%	7	5.8%
女性	0	0.0%	0	0.0%	0	0.0%	0	0.0%	0	0.0%	1	6.7%	0	0.0%	2	4.2%	3	2.3%
男女合計	0	0.0%	0	0.0%	1	5.6%	0	0.0%	0	0.0%	1	3.6%	1	2.1%	7	8.0%	10	4.0%
無回答																		
男性	0	0.0%	0	0.0%	0	0.0%	2	25.0%	0	0.0%	0	0.0%	1	4.0%	1	2.6%	4	3.3%
女性	0	0.0%	0	0.0%	0	0.0%	1	9.1%	1	4.8%	1	6.7%	0	0.0%	1	2.1%	4	3.0%
男女合計	0	0.0%	0	0.0%	0	0.0%	3	15.8%	1	3.0%	1	3.6%	1	2.1%	2	2.3%	8	3.2%
全体(人)																		
男性	4		9		10		8		12		13		25		39		120	
女性	1		5		8		11		21		15		23		48		132	
男女合計	5		14		18		19		33		28		48		87		252	

いわき

	10	割合	20	割合	30	割合	40	割合	50	割合	64	割合	69	割合	70～	割合	全体数	割合
1と回答																		
男性	4	33.3%	4	19.0%	28	54.9%	32	59.3%	26	53.1%	10	40.0%	12	32.4%	35	35.4%	151	43.4%
女性	4	36.4%	11	50.0%	22	55.0%	30	55.6%	31	54.4%	13	40.6%	10	27.8%	46	38.0%	167	44.8%
男女合計	8	34.8%	15	34.9%	50	54.9%	62	57.4%	57	53.8%	23	40.4%	22	30.1%	81	36.8%	318	44.1%
2と回答																		
男性	6	50.0%	13	61.9%	20	39.2%	20	37.0%	19	38.8%	12	48.0%	19	51.4%	56	56.6%	165	47.4%
女性	6	54.5%	8	36.4%	18	45.0%	22	40.7%	23	40.4%	19	59.4%	24	66.7%	63	52.1%	183	49.1%
男女合計	12	52.2%	21	48.8%	38	41.8%	42	38.9%	42	39.6%	31	54.4%	43	58.9%	119	54.1%	348	48.3%
3と回答																		
男性	2	16.7%	2	9.5%	2	3.9%	1	1.9%	2	4.1%	1	4.0%	6	16.2%	4	4.0%	20	5.7%
女性	1	9.1%	1	4.5%	0	0.0%	0	0.0%	2	3.5%	0	0.0%	0	0.0%	5	4.1%	9	2.4%
男女合計	3	13.0%	3	7.0%	2	2.2%	1	0.9%	4	3.8%	1	1.8%	6	8.2%	9	4.1%	29	4.0%
無回答																		
男性	0	0.0%	2	9.5%	1	2.0%	1	1.9%	2	4.1%	2	8.0%	0	0.0%	4	4.0%	12	3.4%
女性	0	0.0%	2	9.1%	0	0.0%	2	3.7%	1	1.8%	0	0.0%	2	5.6%	7	5.8%	14	3.8%
男女合計	0	0.0%	4	9.3%	1	1.1%	3	2.8%	3	2.8%	2	3.5%	2	2.7%	11	5.0%	26	3.6%
全体(人)																		
男性	12		21		51		54		49		25		37		99		348	
女性	11		22		40		54		57		32		36		121		373	
男女合計	23		43		91		108		106		57		73		220		721	

全県(60歳以上・再掲)

	64	割合	69	割合	70	割合	80	割合	90	割合	全体数	割合
1と回答												
男性	99	50.3%	78	31.8%	114	28.6%	77	37.9%	10	55.6%	378	35.6%
女性	88	43.3%	92	36.1%	137	37.2%	108	43.4%	16	30.2%	441	39.1%
男女合計	187	46.8%	170	34.0%	251	32.8%	185	40.9%	26	36.6%	819	37.4%
2と回答												
男性	87	44.2%	141	57.6%	247	62.1%	98	48.3%	6	33.3%	579	54.6%
女性	101	49.8%	145	56.9%	206	56.0%	104	41.8%	25	47.2%	581	51.5%
男女合計	188	47.0%	286	57.2%	453	59.1%	202	44.7%	31	43.7%	1160	53.0%
3と回答												
男性	3	1.5%	15	6.1%	23	5.8%	13	6.4%	1	5.6%	55	5.2%
女性	9	4.4%	8	3.1%	11	3.0%	12	4.8%	3	5.7%	43	3.8%
男女合計	12	3.0%	23	4.6%	34	4.4%	25	5.5%	4	5.6%	98	4.5%
無回答												
男性	8	4.1%	11	4.5%	14	3.5%	15	7.4%	1	5.6%	49	4.6%
女性	5	2.5%	10	3.9%	14	3.8%	25	10.0%	9	17.0%	63	5.6%
男女合計	13	3.3%	21	4.2%	28	3.7%	40	8.8%	10	14.1%	112	5.1%
全体(人)												
男性	197		245		398		203		18		1061	
女性	203		255		368		249		53		1128	
男女合計	400		500		766		452		71		2189	

25 健康づくりのために必要と考えること（満15歳以上対象）（調査票 問25）

問25 あなたは、健康づくりのために何が必要と考えますか。
（記述式 自由回答）

調査回答者4,066人中2,191人から回答があった。

	全 体	男 性	女 性
問25回答者数	2,191 (53.9%)	1,038 (52.2%)	1,153 (55.5%)
調査回答者数	4,066	1,988	2,078

1 「食生活（栄養バランス）」が必要と回答した人

（他の分野（「運動」、「休養、こころの健康」等）との重複回答を含む。集計は、問25の回答者2,191人に対する割合を示す。以下の集計においても同じ）

	10	割合	20	割合	30	割合	40	割合	50	割合	64	割合	69	割合	70	割合	80	割合	90	割合	全体数	割合
男 性	10	38.5%	20	33.9%	39	39.0%	53	43.4%	63	42.9%	39	36.1%	62	45.3%	102	44.9%	34	32.1%	3	50.0%	425	40.9%
女 性	15	44.1%	44	64.7%	50	50.5%	75	49.7%	82	45.6%	66	51.6%	90	61.6%	115	53.5%	59	52.7%	11	55.0%	607	52.6%
男女合計	25	41.7%	64	50.4%	89	44.7%	128	46.9%	145	44.3%	105	44.5%	152	53.7%	217	49.1%	93	42.7%	14	53.8%	1032	47.1%
全体(人)																						
男 性	26		59		100		122		147		108		137		227		106		6		1038	
女 性	34		68		99		151		180		128		146		215		112		20		1153	
男女合計	60		127		199		273		327		236		283		442		218		26		2191	

2 「運動（スポーツ、ウォーキング等）」が必要と回答した人

	10	割合	20	割合	30	割合	40	割合	50	割合	64	割合	69	割合	70	割合	80	割合	90	割合	全体数	割合
男 性	18	69.2%	28	47.5%	50	50.0%	54	44.3%	80	54.4%	56	51.9%	91	66.4%	146	64.3%	61	57.5%	4	66.7%	588	56.6%
女 性	17	50.0%	38	55.9%	59	59.6%	82	54.3%	103	57.2%	82	64.1%	94	64.4%	138	64.2%	68	60.7%	11	55.0%	692	60.0%
男女合計	35	58.3%	66	52.0%	109	54.8%	136	49.8%	183	56.0%	138	58.5%	185	65.4%	284	64.3%	129	59.2%	15	57.7%	1280	58.4%
全体(人)																						
男 性	26		59		100		122		147		108		137		227		106		6		1038	
女 性	34		68		99		151		180		128		146		215		112		20		1153	
男女合計	60		127		199		273		327		236		283		442		218		26		2191	

3 「休養、こころの健康（睡眠、ストレス解消等）」が必要と回答した人

	10	割合	20	割合	30	割合	40	割合	50	割合	64	割合	69	割合	70	割合	80	割合	90	割合	全体数	割合
男 性	10	38.5%	26	44.1%	47	47.0%	42	34.4%	57	38.8%	40	37.0%	39	28.5%	65	28.6%	31	29.2%	1	16.7%	358	34.5%
女 性	17	50.0%	37	54.4%	49	49.5%	76	50.3%	86	47.8%	49	38.3%	73	50.0%	92	42.8%	45	40.2%	6	30.0%	530	46.0%
男女合計	27	45.0%	63	49.6%	96	48.2%	118	43.2%	143	43.7%	89	37.7%	112	39.6%	157	35.5%	76	34.9%	7	26.9%	888	40.5%
全体(人)																						
男 性	26		59		100		122		147		108		137		227		106		6		1038	
女 性	34		68		99		151		180		128		146		215		112		20		1153	
男女合計	60		127		199		273		327		236		283		442		218		26		2191	

4 「生活習慣」が必要と回答した人

	10	割合	20	割合	30	割合	40	割合	50	割合	64	割合	69	割合	70	割合	80	割合	90	割合	全体数	割合
男 性	3	11.5%	8	13.6%	6	6.0%	8	6.6%	8	5.4%	12	11.1%	10	7.3%	15	6.6%	9	8.5%	1	16.7%	80	7.7%
女 性	3	8.8%	3	4.4%	6	6.1%	6	4.0%	15	8.3%	7	5.5%	12	8.2%	17	7.9%	7	6.3%	3	15.0%	79	6.9%
男女合計	6	10.0%	11	8.7%	12	6.0%	14	5.1%	23	7.0%	19	8.1%	22	7.8%	32	7.2%	16	7.3%	4	15.4%	159	7.3%
全体(人)																						
男 性	26		59		100		122		147		108		137		227		106		6		1038	
女 性	34		68		99		151		180		128		146		215		112		20		1153	
男女合計	60		127		199		273		327		236		283		442		218		26		2191	

5 「検査・健診」が必要と回答した人

	10	割合	20	割合	30	割合	40	割合	50	割合	64	割合	69	割合	70	割合	80	割合	90	割合	全体数	割合
男性	1	3.8%	1	1.7%	2	2.0%	6	4.9%	8	5.4%	4	3.7%	13	9.5%	20	8.8%	8	7.5%	0	0.0%	63	6.1%
女性	1	2.9%	1	1.5%	0	0.0%	5	3.3%	9	5.0%	8	6.3%	10	6.8%	12	5.6%	4	3.6%	1	5.0%	51	4.4%
男女合計	2	3.3%	2	1.6%	2	1.0%	11	4.0%	17	5.2%	12	5.1%	23	8.1%	32	7.2%	12	5.5%	1	3.8%	114	5.2%
全体(人)																						
男性	26		59		100		122		147		108		137		227		106		6		1038	
女性	34		68		99		151		180		128		146		215		112		20		1153	
男女合計	60		127		199		273		327		236		283		442		218		26		2191	

6 「禁煙」が必要と回答した人

	10	割合	20	割合	30	割合	40	割合	50	割合	64	割合	69	割合	70	割合	80	割合	90	割合	全体数	割合
男性	0	0.0%	1	1.7%	2	2.0%	1	0.8%	4	2.7%	1	0.9%	1	0.7%	5	2.2%	1	0.9%	0	0.0%	16	1.5%
女性	0	0.0%	1	1.5%	0	0.0%	2	1.3%	4	2.2%	0	0.0%	1	0.7%	1	0.5%	0	0.0%	0	0.0%	9	0.8%
男女合計	0	0.0%	2	1.6%	2	1.0%	3	1.1%	8	2.4%	1	0.4%	2	0.7%	6	1.4%	1	0.5%	0	0.0%	25	1.1%
全体(人)																						
男性	26		59		100		122		147		108		137		227		106		6		1038	
女性	34		68		99		151		180		128		146		215		112		20		1153	
男女合計	60		127		199		273		327		236		283		442		218		26		2191	

7 「その他」が必要と回答した人

	10	割合	20	割合	30	割合	40	割合	50	割合	64	割合	69	割合	70	割合	80	割合	90	割合	全体数	割合
男性	1	3.8%	14	23.7%	15	15.0%	21	17.2%	32	21.8%	26	24.1%	18	13.1%	39	17.2%	24	22.6%	0	0.0%	190	18.3%
女性	6	17.6%	9	13.2%	22	22.2%	29	19.2%	37	20.6%	24	18.8%	28	19.2%	41	19.1%	16	14.3%	3	15.0%	215	18.6%
男女合計	7	11.7%	23	18.1%	37	18.6%	50	18.3%	69	21.1%	50	21.2%	46	16.3%	80	18.1%	40	18.3%	3	11.5%	405	18.5%
全体(人)																						
男性	26		59		100		122		147		108		137		227		106		6		1038	
女性	34		68		99		151		180		128		146		215		112		20		1153	
男女合計	60		127		199		273		327		236		283		442		218		26		2191	

26 自由回答（満15歳以上対象）（調査票 問26）

問26 全体をとおして気づかれた点について、ご自由にお書きください。
（記述式 自由回答）

調査回答者4,066人中592人から回答があった。

	全体	男性	女性
問25回答者数	592 (14.6%)	254 (12.8%)	338 (16.3%)
調査回答者数	4,066	1,988	2,078

県民健康の日 10月10日

「健康ふくしま21計画」の策定を契機に、「すこやか、いきいき、うつくしま」の創造を目指し、県民一人ひとりが「自分の健康は自分で守る」という自覚と認識を高めるとともに、家族ぐるみ、地域ぐるみの積極的な県民参加を基調とした健康づくりを実践することを目的として「県民健康の日」を制定しました。

平成30年度

健康ふくしま21調査報告書

福島県保健福祉部
健康増進課

〒960-8670

福島市杉妻町2番16号(西庁舎7階)
