

令和4年度

健康ふくしま21調査報告書

令和4年10月

令和4年度健康ふくしま21調査事務局
公立大学法人 福島県立医科大学 健康増進センター

目 次

第1章 調査の概要

1	調査の目的	1
2	調査規模（前回令和3年度と同規模）	1
3	主な調査方法	1
4	調査区選定方法	1
5	調査内容	2
	(1) 質問項目	2
	(2) 質問形式	2
6	調査実施時期	2
7	集計について	2
8	調査の実施形態	2
9	調査票等に関する秘密の保持	2
10	調査客体	3
	(1) 調査世帯数	3
	(2) 調査者数	3
	(3) 回答者年齢階級別状況	3
11	集計及び作表方法	4
12	留意点	4
	(1) 数 値	4
	(2) 集計表	4
13	調査票様式	5

第2章 令和4年度健康ふくしま21調査の結果（満15歳以上対象）

1	健康についての意識（調査票 問1）	13
2	健康づくりのために気をつけていること（調査票 問2）	17
3	「県民健康の日」の認知度（調査票 問3）	20
4	食生活（朝食）の状況（調査票 問4）	23
5	食生活（朝食・夕食）の状況（調査票 問5）	26
6	「食育推進月間」「食育の日」の認知度（調査票 問6）	34
7	食生活（栄養バランス）の状況（調査票 問7）	38
8	「フレイル」の認知度（調査票 問8）	41
9	「ロコモティブシンドローム」の認知度（調査票 問9）	44
10	最近1年間の運動状況（調査票 問10）	
	(1) 運動の状況	47
	(2) 運動時間（調査票 問10付問）	51
	(3) 運動習慣の状況（満20歳以上対象）	55
11	喫煙の状況	
	(1) 喫煙の有無（満20歳以上対象）（調査票 問11）	56
	(2) 禁煙の意思（満20歳以上対象）（調査票 問11付問）	60
	(3) 家族（世帯）の喫煙状況（調査票 問12）	64
13	受動喫煙の状況（調査票 問13）	65
14	「COPD（慢性閉塞性肺疾患）」の認知度（調査票 問14）	72

15	飲酒の状況（満20歳以上対象）（調査票 問15）	
(1)	飲酒の頻度	75
(2)	飲酒の量（調査票 問15付問）	79
(3)	飲酒の状況	82
16	定期的な歯科健診の状況（調査票 問16）	84
17	歯みがきの状況（調査票 問17）	87
18	外出の状況（調査票 問18）	90
19	地域活動の実施状況（調査票 問19）	93
20	睡眠時間の状況（調査票 問20）	96
21	睡眠による休養の状況（調査票 問21）	100
22	疲労の状況（調査票 問22）	104
23	健康づくりのために必要と考えること（調査票 問23）	108
24	自由回答（調査票 問24）	109

第3章 前回調査結果との比較（満15歳以上対象） 110

第4章 原子力被災12市町村の調査結果の推移 149

○	平成21年度県民健康調査（田村市、南相馬市、富岡町、浪江町、葛尾村）	
○	平成30年度健康ふくしま21調査（田村市、南相馬市、川俣町、広野町、富岡町、大熊町、浪江町）	
○	令和3年度健康ふくしま21調査（南相馬市、川内村、浪江町、大熊町）	
○	令和4年度健康ふくしま21調査（田村市、南相馬市、川俣町、広野町、楢葉町）	
1	調査客体	149
(1)	調査世帯数	
(2)	調査者数	
(3)	回答者年齢階級別状況	
2	運動の状況	152
(1)	運動の状況	152
(2)	運動時間	157
(3)	運動習慣の状況（満20歳以上対象）	162
3	飲酒の状況（満20歳以上対象）	166
(1)	飲酒の頻度	166
(2)	飲酒の量	172
(3)	飲酒の状況	175
4	疲労の状況	183

第1章 調査の概要

1 調査の目的

本調査は、第二次健康ふくしま21計画の最終評価等を実施するに当たって、数値目標項目の現状の数値を把握するためを行う。

2 調査規模（前回令和3年度と同規模）

- 対象者 約10,000人（15歳以上） 住民基本台帳から世帯及び世帯員を抽出
約4,000世帯 世帯単位で調査を実施、県内の1世帯あたりの人数は、約2.4人（10,000人／2.4人＝約4,166世帯）

3 主な調査方法

令和2年国勢調査を基に、県内7地域から抽出した調査区で、15歳以上の県民（男女）を対象に、郵送による自記式質問紙調査を行う。

4 調査区選定方法

住民基本台帳（令和3年1月1日現在）における7地域別の15歳以上の人口割合及び地域ごとの市（都市部）と町村（郡部）の人口比率を踏まえ、調査区を無作為抽出する。

ただし、回答率の低下を避けるため、令和3年度と同調査で抽出した調査区は今回の調査では選定しない。

県内7地域の15歳以上の人口(令和3年1月1日現在) (人)

方部	A 人口	地域別人口割合	B 市人口	市割合 (B/A)	C 町村人口	町村割合(C/A)
県北	409,080	24.8%	371,518	90.8%	37,562	9.2%
県中	419,768	25.5%	380,008	90.5%	39,760	9.5%
県南	157,357	9.5%	52,980	33.7%	104,377	66.3%
会津	208,229	12.6%	143,534	68.9%	64,695	31.1%
南会津	22,802	1.4%	0	0.0%	22,802	100.0%
相双	149,586	9.1%	83,701	56.0%	65,885	44.0%
いわき	281,719	17.1%	281,719	100.0%	0	0.0%
計	1,648,541	100.0%	1,313,460	79.7%	335,081	20.3%

※人口は住民基本台帳（令和3年1月1日現在）における15歳以上の人口

1万人換算した人口（令和3年1月1日現在）

（人）

方部	A 人口	地域別人口割合	B 市人口	市割合 (B/A)	C 町村人口	町村割合(C/A)
県北	2,481	24.8%	2,253	90.8%	228	9.2%
県中	2,547	25.5%	2,306	90.5%	241	9.5%
県南	955	9.6%	322	33.7%	633	66.3%
会津	1,263	12.6%	871	68.9%	392	31.0%
南会津	138	1.4%	0	0.0%	138	100.0%
相双	907	9.1%	508	56.0%	399	44.0%
いわき	1,709	17.1%	1,709	100.0%	0	0.0%
計	10,000	100.0%	7,969	79.7%	2,031	20.3%

※人口は住民基本台帳（令和3年1月1日現在）における15歳以上の人口

<条件詳細>

- ① 調査対象者数は、15歳以上の県民（男女）約1万人とし、7地域別の人口割合に応じて各地域別に調査区を抽出する。
- ② ただし、令和3年度の同調査で抽出した調査区は今回の調査では選定しない。
- ③ 抽出された調査区の住民基本台帳を閲覧の上、15歳以上の世帯員を確認し、調査対象者とする。

5 調査内容

- (1) 質問項目 比較を可能とするため、令和3年度に実施した健康ふくしま21調査の質問項目をベースとする。
- (2) 質問形式 該当番号を選択することを基本とするが、自由記述も数項目含む。

6 調査実施時期

令和4年5月から令和4年10月まで（名簿作成、督促、集計等の実施時期も含む）

7 集計について

エクセルによるデータ入力及び集計

8 調査の実施形態

委託により実施

9 調査票等に関する秘密の保持

本調査は、健康や生活習慣等について、具体的な情報を取り扱うことから、対象者に係る情報を適切に取り扱い、その個人情報を保護するものとする。

特に、調査を委託して実施することから、受託者へ対し、個人情報の取り扱いに関しては適正な管理と厳重な秘密の保持を求めるものとする。

10 調査客体

県内約14,000の平成27年国勢調査の調査区から選定した107調査区に在住する県民

(1) 調査世帯数

	対象世帯数	回答世帯数	回答率	備 考
県 北	1,247	553	44.3%	23調査区（福島市、二本松市、桑折町、川俣町）
県 中	1,210	503	41.6%	22調査区（郡山市、須賀川市、田村市、石川町、玉川村）
県 南	471	228	48.4%	13調査区（白河市、中島村、矢吹町、棚倉町、埴町）
会 津	557	276	49.6%	14調査区（会津若松市、喜多方市、猪苗代町、湯川村、会津美里町）
南会津	70	31	44.3%	3調査区（南会津町）
相 双	429	154	35.9%	12調査区（相馬市、南相馬市、広野町、檜葉町、新地町）
いわき	785	367	46.8%	14調査区（いわき市）
総 数	4,769	2,112	44.3%	(101調査区)

(2) 調査者数

	対象者数	回答者数	回答率	回答者男女別		備 考
				男	女	
県 北	2,602	1,069	41.1%	501	568	
県 中	2,735	1,007	36.8%	492	515	
県 南	1,045	461	44.1%	215	246	
会 津	1,317	573	43.5%	273	300	
南会津	150	56	37.3%	30	26	
相 双	977	311	31.8%	153	158	
いわき	1,807	735	40.7%	352	383	
総 数	10,633	4,212	39.6%	2,016	2,196	

(3) 回答者年齢階級別状況

年齢階級	総 数	男	女	備 考
15～19歳	156	82	74	
20～29歳	248	123	125	
30～39歳	375	192	183	
40～49歳	502	238	264	
50～59歳	658	312	346	
60～64歳	404	196	208	
65～69歳	432	211	221	
70～79歳	857	432	425	
80～89歳	464	187	277	
90歳～	116	43	73	
合 計	4,212	2,016	2,196	

11 集計及び作表方法

集計にあたっては、被調査世帯から記入後の調査票の返送を受けた後、計算ソフト「エクセル」を利用してデータを入力、集計し、作表を行った。

12 留意点

(1) 数 値

- %値：基数を100%とし、グラフや表では小数第2位を四捨五入して小数第1位までを表示している。
(注意) 四捨五入の関係で、個々を合計した%値と合わないことがある。
- 0.0：%値が0または、0.05に満たなかったもの。

(2) 集 計 表

集計表については、県全体の集計結果及び各地域別の集計結果を、調査票の設問順に掲載している（一部を除く）。

- 集計表においては、各年代ごとに、その人数及び割合（%）を記載

市町村名

地区番号

令和4年度
健康ふくしま21調査
質問紙

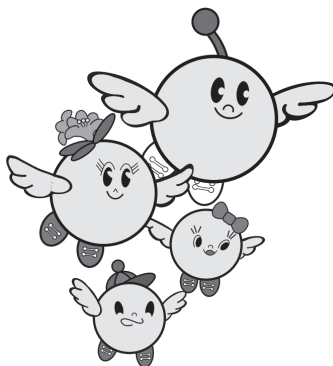

1 この質問紙は、満15歳以上(令和4年4月1日現在)の方がそれぞれ回答し、ご本人の記入が難しい場合は、代理の方に記入していただくようお願いいたします。

2 性別と年齢を必ず記入願います。(氏名の記入は必要ありません。)

性 別

1 男 2 女

(あてはまる番号に○)

年 齢

歳

(令和4年4月1日現在の年齢)

3 回答の仕方は、あてはまる番号に○をつけるものと、必要なことから書き込むものがあります。

福島県

公立大学法人福島県立医科大学 健康増進センター

(令和4年度健康ふくしま21調査 事務局)

お問い合わせ先：024-547-1788 (月～金 9時～17時まで) ※祝日は除く

【健康づくりについて】

問1 あなたは、ふだん自分で健康だと思われますか。
(あてはまる番号1つに○)

- 1 非常に健康だと思う 2 まあ健康な方だと思う
3 あまり健康ではない 4 健康ではない

問2 あなたは、健康づくりのためにどのようなことに気をつけていますか。
(あてはまる番号すべてに○)

- 1 食生活に気をつけている
2 歩いたり軽い体操をしている
3 スポーツやランニングをしている
4 休養や睡眠を十分とるようにしている
5 酒を控えるようにしている
6 たばこを吸わないようにしている
7 定期的に健康診断を受けるようにしている
8 趣味や生きがいをもち、生活にメリハリを持たせるようにしている
9 健康補助食品などを利用している
10 その他(具体的に)
11 特に何もしていない

問3 あなたは、福島県において、10月10日が「県民健康の日」であることを知っていますか。

- 1 知っている 2 知らない

【栄養・食生活について】

問4 あなたは、朝食をだいたい毎日とっていますか。

- 1 はい 2 いいえ

問5 あなたは、朝食、夕食を家族とどのくらい一緒に食べていますか。

	ほとんど毎日	週に4～5日	週に2～3日	週に1日程度	ほとんどひとり
朝食	1	2	3	4	5
夕食	1	2	3	4	5

問6 あなたは、食育推進月間（6月）と食育の日（毎月19日）を知っていますか。
（あてはまる番号1つに○）

- 1 知っている
- 2 名称は知っているが、月日までは知らない
- 3 知らない

問7 あなたは、日頃から栄養バランスのとれた食生活を実践していますか。

- 1 はい
- 2 いいえ

【身体活動・運動について】

問8 あなたは、フレイルを知っていますか。

- 1 知っている
- 2 知らない

フレイル

健康な状態から、加齢によって、体や心のはたらき、社会とのつながりが弱くなった状態を言います。適切な治療や予防を行うことで要介護状態に進まないよう改善できる可能性があります。

問9 あなたは、ロコモティブシンドローム（運動器症候群）を知っていますか。

- 1 知っている
- 2 知らない

ロコモティブシンドローム（運動器症候群）

骨や関節、筋肉などの運動器のおとろえや障がいで介護を必要とする状態、または必要となる可能性の高い状態を言います。

問10 最近1年間の運動について、あてはまるものを1つ選んで○をつけてください。

- 1 何らかの運動をほとんど毎日している。（付問へ）
- 2 何らかの運動を週2～4回程度している。（付問へ）
- 3 何らかの運動を週1回程度している。（付問へ）
- 4 ほとんど（まったく）していない。

付問 問10で1～3を選んだ方におたずねします。

1回の運動時間はどれくらいですか。複数の運動をしている方は、もっとも運動時間の長いものについてお答えください。

- 1 15分未満
- 2 15～30分未満
- 3 30分以上

問14 あなたは、「COPD（慢性閉塞性肺疾患）」という病気を知っていますか。

- 1 知っている 2 知らない

COPD（慢性閉塞性肺疾患）

空気の通り道である肺の気管支が炎症を起こしたり、酸素を取り込む肺胞が壊れたりして肺機能が低下する病気です。息切れや、せき・たんが何年にもわたって続き、息を吐く時間がのび、ぜいぜいするという症状があります。肺の生活習慣病とも言われており、最大の原因は喫煙です。喫煙者の15～20%が発症します。

【飲酒について】

問15 あなたは、どのくらいお酒を飲んでいますか。（あてはまる番号1つに○）
20歳以上の方のみお答えください。

- 1 毎日飲んでいる（付問へ） 2 週に5～6回飲んでいる（付問へ）
3 週に3～4回飲んでいる（付問へ） 4 たまに飲む程度（付問へ）
5 以前は飲んでいたが、今は飲んでいない 6 もともと飲まない

付問 問15で1～4を選んだ方におたずねします。あなたが1回に飲む量はどれくらいですか。日本酒にあてはめて計算し、あてはまる番号を1つ選んで○をつけてください。（計算の仕方は、下記のとおりです。）

- 1 極少量 2 1合程度
3 2合程度 4 3合以上

日本酒1合あたりのアルコール量は以下と同等

- ・焼酎（25度、100ml）
- ・ビール中瓶1本（500ml）
- ・ウィスキーダブル1杯（60ml）
- ・ワイングラス2杯（200ml）

うすめて飲むときは、もとの量で計算してください。

【歯・口腔の健康について】

問16 あなたは、定期的に歯科健診（歯石の除去、歯面清掃を含む）を受けていますか。

- 1 はい 2 いいえ

問17 あなたは、毎食後（1日3回以上）歯をみがいていますか。

- 1 はい 2 いいえ

【その他】

問23 あなたは、健康づくりのために何が必要だと考えていますか。

()

問24 全体を通して気付かれた点について、御自由にお書きください。

()

記入して下さったのはどなたですか。

- 1 本人 2 代理人（続柄を教えてください。 ）



以上で終了です。

お忙しいところ、御協力ありがとうございました。

この質問紙は、同封の返信用封筒（切手不要）に入れて、7月25日（月）までにポストに投かんしてください。

1 健康についての意識（調査票 問1）

問1 あなたは、ふだん自分で健康だと思えますか。（あてはまる番号1つに○）

- 1 非常に健康だと思ふ 2 まあ健康な方だと思ふ
- 3 あまり健康ではない 4 健康ではない

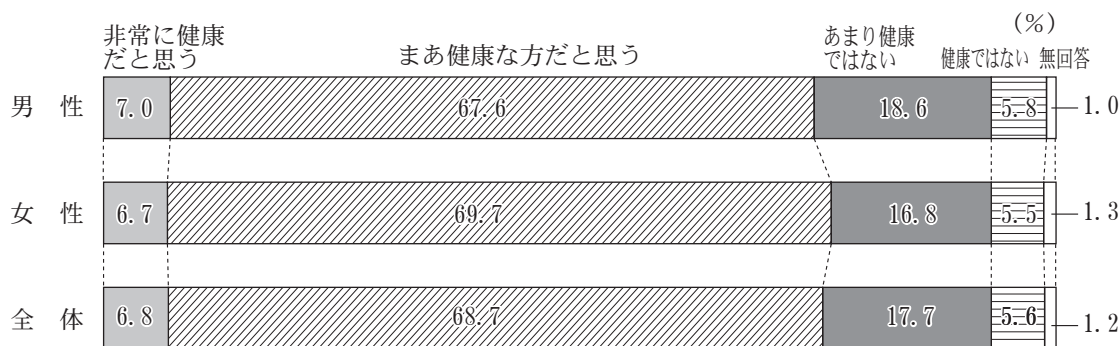

	10	割合	20	割合	30	割合	40	割合	50	割合	64	割合	69	割合	70	割合	80	割合	90	割合	全体数	割合
1と回答																						
男性	27	32.9%	25	20.3%	18	9.4%	10	4.2%	13	4.2%	11	5.6%	9	4.3%	15	3.5%	11	5.9%	2	4.7%	141	7.0%
女性	24	32.4%	26	20.8%	14	7.7%	16	6.1%	14	4.0%	6	2.9%	14	6.3%	23	5.4%	10	3.6%	0	0.0%	147	6.7%
男女合計	51	32.7%	51	20.6%	32	8.5%	26	5.2%	27	4.1%	17	4.2%	23	5.3%	38	4.4%	21	4.5%	2	1.7%	288	6.8%
2と回答																						
男性	47	57.3%	83	67.5%	128	66.7%	185	77.7%	209	67.0%	129	65.8%	149	70.6%	300	69.4%	109	58.3%	24	55.8%	1363	67.6%
女性	39	52.7%	88	70.4%	137	74.9%	190	72.0%	257	74.3%	166	79.8%	165	74.7%	284	66.8%	165	59.6%	39	53.4%	1530	69.7%
男女合計	86	55.1%	171	69.0%	265	70.7%	375	74.7%	466	70.8%	295	73.0%	314	72.7%	584	68.1%	274	59.1%	63	54.3%	2893	68.7%
3と回答																						
男性	8	9.8%	13	10.6%	36	18.8%	40	16.8%	67	21.5%	44	22.4%	36	17.1%	83	19.2%	38	20.3%	9	20.9%	374	18.6%
女性	9	12.2%	8	6.4%	26	14.2%	49	18.6%	61	17.6%	30	14.4%	29	13.1%	78	18.4%	61	22.0%	19	26.0%	370	16.8%
男女合計	17	10.9%	21	8.5%	62	16.5%	89	17.7%	128	19.5%	74	18.3%	65	15.0%	161	18.8%	99	21.3%	28	24.1%	744	17.7%
4と回答																						
男性	0	0.0%	2	1.6%	8	4.2%	2	0.8%	21	6.7%	10	5.1%	14	6.6%	32	7.4%	22	11.8%	6	14.0%	117	5.8%
女性	2	2.7%	3	2.4%	6	3.3%	8	3.0%	12	3.5%	6	2.9%	8	3.6%	27	6.4%	34	12.3%	14	19.2%	120	5.5%
男女合計	2	1.3%	5	2.0%	14	3.7%	10	2.0%	33	5.0%	16	4.0%	22	5.1%	59	6.9%	56	12.1%	20	17.2%	237	5.6%
無回答																						
男性	0	0.0%	0	0.0%	2	1.0%	1	0.4%	2	0.6%	2	1.0%	3	1.4%	2	0.5%	7	3.7%	2	4.7%	21	1.0%
女性	0	0.0%	0	0.0%	0	0.0%	1	0.4%	2	0.6%	0	0.0%	5	2.3%	13	3.1%	7	2.5%	1	1.4%	29	1.3%
男女合計	0	0.0%	0	0.0%	2	0.5%	2	0.4%	4	0.6%	2	0.5%	8	1.9%	15	1.8%	14	3.0%	3	2.6%	50	1.2%
全体(人)																						
男性	82		123		192		238		312		196		211		432		187		43		2016	
女性	74		125		183		264		346		208		221		425		277		73		2196	
男女合計	156		248		375		502		658		404		432		857		464		116		4212	

県 北

	10	割合	20	割合	30	割合	40	割合	50	割合	64	割合	69	割合	70～	割合	全体数	割合
1と回答																		
男性	7	29.2%	13	27.7%	8	18.2%	4	7.0%	4	4.6%	5	10.2%	3	5.8%	7	5.0%	51	10.2%
女性	6	40.0%	10	22.2%	3	6.7%	4	5.8%	4	3.8%	0	0.0%	6	10.9%	7	3.7%	40	7.0%
男女合計	13	33.3%	23	25.0%	11	12.4%	8	6.3%	8	4.1%	5	5.4%	9	8.4%	14	4.2%	91	8.5%
2と回答																		
男性	15	62.5%	28	59.6%	27	61.4%	40	70.2%	58	66.7%	35	71.4%	33	63.5%	93	66.0%	329	65.7%
女性	7	46.7%	30	66.7%	34	75.6%	49	71.0%	81	76.4%	38	86.4%	40	72.7%	112	59.3%	391	68.8%
男女合計	22	56.4%	58	63.0%	61	68.5%	89	70.6%	139	72.0%	73	78.5%	73	68.2%	205	62.1%	720	67.4%
3と回答																		
男性	2	8.3%	4	8.5%	8	18.2%	11	19.3%	18	20.7%	7	14.3%	11	21.2%	27	19.1%	88	17.6%
女性	2	13.3%	2	4.4%	7	15.6%	15	21.7%	18	17.0%	6	13.6%	5	9.1%	35	18.5%	90	15.8%
男女合計	4	10.3%	6	6.5%	15	16.9%	26	20.6%	36	18.7%	13	14.0%	16	15.0%	62	18.8%	178	16.7%
4と回答																		
男性	0	0.0%	2	4.3%	0	0.0%	2	3.5%	7	8.0%	2	4.1%	4	7.7%	13	9.2%	30	6.0%
女性	0	0.0%	3	6.7%	1	2.2%	1	1.4%	2	1.9%	0	0.0%	3	5.5%	30	15.9%	40	7.0%
男女合計	0	0.0%	5	5.4%	1	1.1%	3	2.4%	9	4.7%	2	2.2%	7	6.5%	43	13.0%	70	6.5%
無回答																		
男性	0	0.0%	0	0.0%	1	2.3%	0	0.0%	0	0.0%	0	0.0%	1	1.9%	1	0.7%	3	0.6%
女性	0	0.0%	0	0.0%	0	0.0%	0	0.0%	1	0.9%	0	0.0%	1	1.8%	5	2.6%	7	1.2%
男女合計	0	0.0%	0	0.0%	1	1.1%	0	0.0%	1	0.5%	0	0.0%	2	1.9%	6	1.8%	10	0.9%
全体(人)																		
男性	24		47		44		57		87		49		52		141		501	
女性	15		45		45		69		106		44		55		189		568	
男女合計	39		92		89		126		193		93		107		330		1069	

県 中

	10	割合	20	割合	30	割合	40	割合	50	割合	64	割合	69	割合	70～	割合	全体数	割合
1と回答																		
男性	7	33.3%	3	9.4%	5	9.8%	3	4.5%	3	3.4%	2	4.3%	2	4.5%	7	4.9%	32	6.5%
女性	6	30.0%	9	24.3%	5	9.3%	4	5.5%	4	5.1%	2	4.0%	2	4.5%	5	3.2%	37	7.2%
男女合計	13	31.7%	12	17.4%	10	9.5%	7	5.0%	7	4.2%	4	4.1%	4	4.5%	12	4.0%	69	6.9%
2と回答																		
男性	12	57.1%	25	78.1%	29	56.9%	53	80.3%	55	62.5%	33	70.2%	26	59.1%	96	67.1%	329	66.9%
女性	10	50.0%	27	73.0%	35	64.8%	52	71.2%	56	70.9%	35	70.0%	35	79.5%	101	63.9%	351	68.2%
男女合計	22	53.7%	52	75.4%	64	61.0%	105	75.5%	111	66.5%	68	70.1%	61	69.3%	197	65.4%	680	67.5%
3と回答																		
男性	2	9.5%	4	12.5%	14	27.5%	10	15.2%	24	27.3%	9	19.1%	13	29.5%	22	15.4%	98	19.9%
女性	3	15.0%	1	2.7%	10	18.5%	13	17.8%	18	22.8%	9	18.0%	6	13.6%	35	22.2%	95	18.4%
男女合計	5	12.2%	5	7.2%	24	22.9%	23	16.5%	42	25.1%	18	18.6%	19	21.6%	57	18.9%	193	19.2%
4と回答																		
男性	0	0.0%	0	0.0%	3	5.9%	0	0.0%	4	4.5%	3	6.4%	3	6.8%	16	11.2%	29	5.9%
女性	1	5.0%	0	0.0%	4	7.4%	4	5.5%	1	1.3%	4	8.0%	1	2.3%	10	6.3%	25	4.9%
男女合計	1	2.4%	0	0.0%	7	6.7%	4	2.9%	5	3.0%	7	7.2%	4	4.5%	26	8.6%	54	5.4%
無回答																		
男性	0	0.0%	0	0.0%	0	0.0%	0	0.0%	2	2.3%	0	0.0%	0	0.0%	2	1.4%	4	0.8%
女性	0	0.0%	0	0.0%	0	0.0%	0	0.0%	0	0.0%	0	0.0%	0	0.0%	7	4.4%	7	1.4%
男女合計	0	0.0%	0	0.0%	0	0.0%	0	0.0%	2	1.2%	0	0.0%	0	0.0%	9	3.0%	11	1.1%
全体(人)																		
男性	21		32		51		66		88		47		44		143		492	
女性	20		37		54		73		79		50		44		158		515	
男女合計	41		69		105		139		167		97		88		301		1007	

県 南

	10	割合	20	割合	30	割合	40	割合	50	割合	64	割合	69	割合	70～	割合	全体数	割合
1と回答																		
男性	2	16.7%	1	14.3%	0	0.0%	1	4.8%	2	5.9%	1	4.8%	2	9.5%	2	2.5%	11	5.1%
女性	5	50.0%	3	27.3%	0	0.0%	4	14.3%	0	0.0%	1	3.8%	0	0.0%	3	3.1%	16	6.5%
男女合計	7	31.8%	4	22.2%	0	0.0%	5	10.2%	2	2.9%	2	4.3%	2	4.4%	5	2.8%	27	5.9%
2と回答																		
男性	8	66.7%	6	85.7%	15	75.0%	15	71.4%	20	58.8%	14	66.7%	15	71.4%	50	63.3%	143	66.5%
女性	5	50.0%	6	54.5%	13	86.7%	19	67.9%	25	71.4%	22	84.6%	20	83.3%	62	63.9%	172	69.9%
男女合計	13	59.1%	12	66.7%	28	80.0%	34	69.4%	45	65.2%	36	76.6%	35	77.8%	112	63.6%	315	68.3%
3と回答																		
男性	2	16.7%	0	0.0%	4	20.0%	5	23.8%	10	29.4%	6	28.6%	3	14.3%	18	22.8%	48	22.3%
女性	0	0.0%	2	18.2%	2	13.3%	4	14.3%	9	25.7%	3	11.5%	3	12.5%	23	23.7%	46	18.7%
男女合計	2	9.1%	2	11.1%	6	17.1%	9	18.4%	19	27.5%	9	19.1%	6	13.3%	41	23.3%	94	20.4%
4と回答																		
男性	0	0.0%	0	0.0%	1	5.0%	0	0.0%	2	5.9%	0	0.0%	0	0.0%	8	10.1%	11	5.1%
女性	0	0.0%	0	0.0%	0	0.0%	1	3.6%	1	2.9%	0	0.0%	1	4.2%	6	6.2%	9	3.7%
男女合計	0	0.0%	0	0.0%	1	2.9%	1	2.0%	3	4.3%	0	0.0%	1	2.2%	14	8.0%	20	4.3%
無回答																		
男性	0	0.0%	0	0.0%	0	0.0%	0	0.0%	0	0.0%	0	0.0%	1	4.8%	1	1.3%	2	0.9%
女性	0	0.0%	0	0.0%	0	0.0%	0	0.0%	0	0.0%	0	0.0%	0	0.0%	3	3.1%	3	1.2%
男女合計	0	0.0%	0	0.0%	0	0.0%	0	0.0%	0	0.0%	0	0.0%	1	2.2%	4	2.3%	5	1.1%
全体(人)																		
男性	12		7		20		21		34		21		21		79		215	
女性	10		11		15		28		35		26		24		97		246	
男女合計	22		18		35		49		69		47		45		176		461	

会 津

	10	割合	20	割合	30	割合	40	割合	50	割合	64	割合	69	割合	70～	割合	全体数	割合
1と回答																		
男性	3	50.0%	3	16.7%	3	10.7%	1	2.3%	2	6.3%	0	0.0%	0	0.0%	8	8.1%	20	7.3%
女性	1	14.3%	3	27.3%	2	8.0%	3	7.9%	1	2.4%	1	3.6%	2	6.3%	5	4.3%	18	6.0%
男女合計	4	30.8%	6	20.7%	5	9.4%	4	4.9%	3	4.1%	1	2.0%	2	3.5%	13	6.0%	38	6.6%
2と回答																		
男性	2	33.3%	13	72.2%	21	75.0%	35	81.4%	22	68.8%	12	54.5%	19	76.0%	66	66.7%	190	69.6%
女性	4	57.1%	8	72.7%	18	72.0%	30	78.9%	31	73.8%	24	85.7%	26	81.3%	79	67.5%	220	73.3%
男女合計	6	46.2%	21	72.4%	39	73.6%	65	80.2%	53	71.6%	36	72.0%	45	78.9%	145	67.1%	410	71.6%
3と回答																		
男性	1	16.7%	2	11.1%	3	10.7%	7	16.3%	6	18.8%	7	31.8%	4	16.0%	15	15.2%	45	16.5%
女性	2	28.6%	0	0.0%	5	20.0%	3	7.9%	5	11.9%	3	10.7%	3	9.4%	24	20.5%	45	15.0%
男女合計	3	23.1%	2	6.9%	8	15.1%	10	12.3%	11	14.9%	10	20.0%	7	12.3%	39	18.1%	90	15.7%
4と回答																		
男性	0	0.0%	0	0.0%	1	3.6%	0	0.0%	2	6.3%	2	9.1%	2	8.0%	8	8.1%	15	5.5%
女性	0	0.0%	0	0.0%	0	0.0%	2	5.3%	5	11.9%	0	0.0%	0	0.0%	6	5.1%	13	4.3%
男女合計	0	0.0%	0	0.0%	1	1.9%	2	2.5%	7	9.5%	2	4.0%	2	3.5%	14	6.5%	28	4.9%
無回答																		
男性	0	0.0%	0	0.0%	0	0.0%	0	0.0%	0	0.0%	1	4.5%	0	0.0%	2	2.0%	3	1.1%
女性	0	0.0%	0	0.0%	0	0.0%	0	0.0%	0	0.0%	0	0.0%	1	3.1%	3	2.6%	4	1.3%
男女合計	0	0.0%	0	0.0%	0	0.0%	0	0.0%	0	0.0%	1	2.0%	1	1.8%	5	2.3%	7	1.2%
全体(人)																		
男性	6		18		28		43		32		22		25		99		273	
女性	7		11		25		38		42		28		32		117		300	
男女合計	13		29		53		81		74		50		57		216		573	

南 会 津

	10	割合	20	割合	30	割合	40	割合	50	割合	64	割合	69	割合	70～	割合	全体数	割合
1と回答																		
男性	0	0.0%	1	33.3%	0	0.0%	0	0.0%	0	0.0%	0	0.0%	1	25.0%	1	7.1%	3	10.0%
女性	0	0.0%	0	0.0%	0	0.0%	0	0.0%	0	0.0%	0	0.0%	0	0.0%	0	0.0%	0	0.0%
男女合計	0	0.0%	1	33.3%	0	0.0%	0	0.0%	0	0.0%	0	0.0%	1	12.5%	1	3.7%	3	5.4%
2と回答																		
男性	0	0.0%	1	33.3%	1	50.0%	2	66.7%	3	100.0%	0	0.0%	3	75.0%	9	64.3%	19	63.3%
女性	0	0.0%	0	0.0%	2	100.0%	2	66.7%	1	100.0%	2	66.7%	4	100.0%	8	61.5%	19	73.1%
男女合計	0	0.0%	1	33.3%	3	75.0%	4	66.7%	4	100.0%	2	50.0%	7	87.5%	17	63.0%	38	67.9%
3と回答																		
男性	0	0.0%	1	33.3%	1	50.0%	1	33.3%	0	0.0%	1	100.0%	0	0.0%	3	21.4%	7	23.3%
女性	0	0.0%	0	0.0%	0	0.0%	1	33.3%	0	0.0%	1	33.3%	0	0.0%	3	23.1%	5	19.2%
男女合計	0	0.0%	1	33.3%	1	25.0%	2	33.3%	0	0.0%	2	50.0%	0	0.0%	6	22.2%	12	21.4%
4と回答																		
男性	0	0.0%	0	0.0%	0	0.0%	0	0.0%	0	0.0%	0	0.0%	0	0.0%	1	7.1%	1	3.3%
女性	0	0.0%	0	0.0%	0	0.0%	0	0.0%	0	0.0%	0	0.0%	0	0.0%	2	15.4%	2	7.7%
男女合計	0	0.0%	0	0.0%	0	0.0%	0	0.0%	0	0.0%	0	0.0%	0	0.0%	3	11.1%	3	5.4%
無回答																		
男性	0	0.0%	0	0.0%	0	0.0%	0	0.0%	0	0.0%	0	0.0%	0	0.0%	0	0.0%	0	0.0%
女性	0	0.0%	0	0.0%	0	0.0%	0	0.0%	0	0.0%	0	0.0%	0	0.0%	0	0.0%	0	0.0%
男女合計	0	0.0%	0	0.0%	0	0.0%	0	0.0%	0	0.0%	0	0.0%	0	0.0%	0	0.0%	0	0.0%
全体(人)																		
男性	0		3		2		3		3		1		4		14		30	
女性	0		0		2		3		1		3		4		13		26	
男女合計	0		3		4		6		4		4		8		27		56	

相 双

	10	割合	20	割合	30	割合	40	割合	50	割合	64	割合	69	割合	70～	割合	全体数	割合
1と回答																		
男性	4	66.7%	1	16.7%	1	8.3%	0	0.0%	0	0.0%	1	7.1%	0	0.0%	2	3.5%	9	5.9%
女性	2	33.3%	1	25.0%	2	14.3%	0	0.0%	2	10.0%	0	0.0%	1	5.3%	3	5.0%	11	7.0%
男女合計	6	50.0%	2	20.0%	3	11.5%	0	0.0%	2	5.0%	1	4.0%	1	2.6%	5	4.3%	20	6.4%
2と回答																		
男性	2	33.3%	3	50.0%	9	75.0%	15	83.3%	16	80.0%	8	57.1%	18	90.0%	35	61.4%	106	69.3%
女性	3	50.0%	3	75.0%	12	85.7%	18	75.0%	13	65.0%	8	72.7%	12	63.2%	36	60.0%	105	66.5%
男女合計	5	41.7%	6	60.0%	21	80.8%	33	78.6%	29	72.5%	16	64.0%	30	76.9%	71	60.7%	211	67.8%
3と回答																		
男性	0	0.0%	2	33.3%	1	8.3%	3	16.7%	3	15.0%	4	28.6%	2	10.0%	17	29.8%	32	20.9%
女性	1	16.7%	0	0.0%	0	0.0%	6	25.0%	3	15.0%	3	27.3%	4	21.1%	13	21.7%	30	19.0%
男女合計	1	8.3%	2	20.0%	1	3.8%	9	21.4%	6	15.0%	7	28.0%	6	15.4%	30	25.6%	62	19.9%
4と回答																		
男性	0	0.0%	0	0.0%	1	8.3%	0	0.0%	1	5.0%	0	0.0%	0	0.0%	2	3.5%	4	2.6%
女性	0	0.0%	0	0.0%	0	0.0%	0	0.0%	1	5.0%	0	0.0%	2	10.5%	7	11.7%	10	6.3%
男女合計	0	0.0%	0	0.0%	1	3.8%	0	0.0%	2	5.0%	0	0.0%	2	5.1%	9	7.7%	14	4.5%
無回答																		
男性	0	0.0%	0	0.0%	0	0.0%	0	0.0%	0	0.0%	1	7.1%	0	0.0%	1	1.8%	2	1.3%
女性	0	0.0%	0	0.0%	0	0.0%	0	0.0%	1	5.0%	0	0.0%	0	0.0%	1	1.7%	2	1.3%
男女合計	0	0.0%	0	0.0%	0	0.0%	0	0.0%	1	2.5%	1	4.0%	0	0.0%	2	1.7%	4	1.3%
全体(人)																		
男性	6		6		12		18		20		14		20		57		153	
女性	6		4		14		24		20		11		19		60		158	
男女合計	12		10		26		42		40		25		39		117		311	

いわき

	10	割合	20	割合	30	割合	40	割合	50	割合	64	割合	69	割合	70～	割合	全体数	割合
1と回答																		
男性	4	30.8%	3	30.0%	1	2.9%	1	3.3%	2	4.2%	2	4.8%	1	2.2%	1	0.8%	15	4.3%
女性	4	25.0%	0	0.0%	2	7.1%	1	3.4%	3	4.8%	2	4.3%	3	7.0%	10	7.1%	25	6.5%
男女合計	8	27.6%	3	11.1%	3	4.8%	2	3.4%	5	4.5%	4	4.5%	4	4.5%	11	4.1%	40	5.4%
2と回答																		
男性	8	61.5%	7	70.0%	26	74.3%	25	83.3%	35	72.9%	27	64.3%	35	77.8%	84	65.1%	247	70.2%
女性	10	62.5%	14	82.4%	23	82.1%	20	69.0%	50	79.4%	37	80.4%	28	65.1%	90	63.8%	272	71.0%
男女合計	18	62.1%	21	77.8%	49	77.8%	45	76.3%	85	76.6%	64	72.7%	63	71.6%	174	64.4%	519	70.6%
3と回答																		
男性	1	7.7%	0	0.0%	5	14.3%	3	10.0%	6	12.5%	10	23.8%	3	6.7%	28	21.7%	56	15.9%
女性	1	6.3%	3	17.6%	2	7.1%	7	24.1%	8	12.7%	5	10.9%	8	18.6%	25	17.7%	59	15.4%
男女合計	2	6.9%	3	11.1%	7	11.1%	10	16.9%	14	12.6%	15	17.0%	11	12.5%	53	19.6%	115	15.6%
4と回答																		
男性	0	0.0%	0	0.0%	2	5.7%	0	0.0%	5	10.4%	3	7.1%	5	11.1%	12	9.3%	27	7.7%
女性	1	6.3%	0	0.0%	1	3.6%	0	0.0%	2	3.2%	2	4.3%	1	2.3%	14	9.9%	21	5.5%
男女合計	1	3.4%	0	0.0%	3	4.8%	0	0.0%	7	6.3%	5	5.7%	6	6.8%	26	9.6%	48	6.5%
無回答																		
男性	0	0.0%	0	0.0%	1	2.9%	1	3.3%	0	0.0%	0	0.0%	1	2.2%	4	3.1%	7	2.0%
女性	0	0.0%	0	0.0%	0	0.0%	1	3.4%	0	0.0%	0	0.0%	3	7.0%	2	1.4%	6	1.6%
男女合計	0	0.0%	0	0.0%	1	1.6%	2	3.4%	0	0.0%	0	0.0%	4	4.5%	6	2.2%	13	1.8%
全体(人)																		
男性	13		10		35		30		48		42		45		129		352	
女性	16		17		28		29		63		46		43		141		383	
男女合計	29		27		63		59		111		88		88		270		735	

全県(60歳以上・再掲)

	64	割合	69	割合	70	割合	80	割合	90	割合	全体数	割合
1と回答												
男性	11	5.6%	9	4.3%	15	3.5%	11	5.9%	2	4.7%	48	4.5%
女性	6	2.9%	14	6.3%	23	5.4%	10	3.6%	0	0.0%	53	4.4%
男女合計	17	4.2%	23	5.3%	38	4.4%	21	4.5%	2	1.7%	101	4.4%
2と回答												
男性	129	65.8%	149	70.6%	300	69.4%	109	58.3%	24	55.8%	711	66.5%
女性	166	79.8%	165	74.7%	284	66.8%	165	59.6%	39	53.4%	819	68.0%
男女合計	295	73.0%	314	72.7%	584	68.1%	274	59.1%	63	54.3%	1530	67.3%
3と回答												
男性	44	22.4%	36	17.1%	83	19.2%	38	20.3%	9	20.9%	210	19.6%
女性	30	14.4%	29	13.1%	78	18.4%	61	22.0%	19	26.0%	217	18.0%
男女合計	74	18.3%	65	15.0%	161	18.8%	99	21.3%	28	24.1%	427	18.8%
4と回答												
男性	10	5.1%	14	6.6%	32	7.4%	22	11.8%	6	14.0%	84	7.9%
女性	6	2.9%	8	3.6%	27	6.4%	34	12.3%	14	19.2%	89	7.4%
男女合計	16	4.0%	22	5.1%	59	6.9%	56	12.1%	20	17.2%	173	7.6%
無回答												
男性	2	1.0%	3	1.4%	2	0.5%	7	3.7%	2	4.7%	16	1.5%
女性	0	0.0%	5	2.3%	13	3.1%	7	2.5%	1	1.4%	26	2.2%
男女合計	2	0.5%	8	1.9%	15	1.8%	14	3.0%	3	2.6%	42	1.8%
全体(人)												
男性	196		211		432		187		43		1069	
女性	208		221		425		277		73		1204	
男女合計	404		432		857		464		116		2273	

2 健康づくりのために気をつけていること（調査票 問2）

問2 あなたは、健康づくりのためにどのようなことに気をつけていますか。（あてはまる番号すべてに○）

- 1 食生活に気をつけている
- 2 歩いたり軽い体操をしている
- 3 スポーツやランニングをしている
- 4 休養や睡眠を十分とるようにしている
- 5 酒を控えるようにしている
- 6 たばこを吸わないようにしている
- 7 定期的に健康診断を受けるようにしている
- 8 趣味や生きがいをもち、生活にメリハリを持たせるようにしている
- 9 健康補助食品などを利用している
- 10 その他
- 11 特に何もしていない

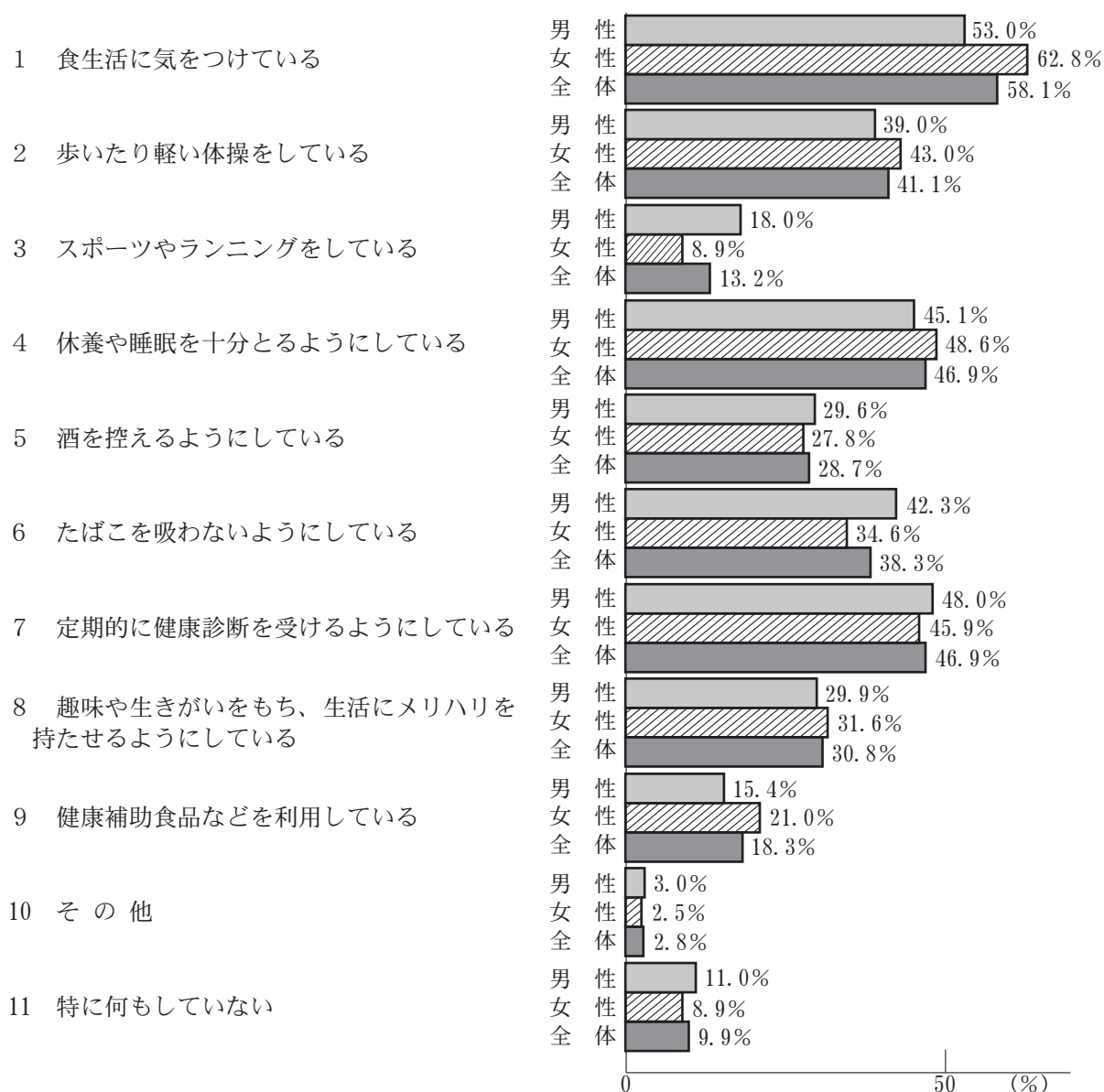

1. 食生活に気をつけていると回答した人

	10	割合	20	割合	30	割合	40	割合	50	割合	64	割合	69	割合	70	割合	80	割合	90	割合	全体数	割合
1に○																						
男性	24	29.3%	45	36.6%	75	39.1%	101	42.4%	154	49.4%	101	51.5%	132	62.6%	293	67.8%	123	65.8%	21	48.8%	1069	53.0%
女性	25	33.8%	56	44.8%	78	42.6%	145	54.9%	222	64.2%	136	65.4%	161	72.9%	315	74.1%	200	72.2%	41	56.2%	1379	62.8%
男女合計	49	31.4%	101	40.7%	153	40.8%	246	49.0%	376	57.1%	237	58.7%	293	67.8%	608	70.9%	323	69.6%	62	53.4%	2448	58.1%
全体(人)																						
男性	82		123		192		238		312		196		211		432		187		43		2016	
女性	74		125		183		264		346		208		221		425		277		73		2196	
男女合計	156		248		375		502		658		404		432		857		464		116		4212	

2. 歩いたり軽い体操をしていると回答した人

	10	割合	20	割合	30	割合	40	割合	50	割合	64	割合	69	割合	70	割合	80	割合	90	割合	全体数	割合
2に○																						
男性	24	29.3%	31	25.2%	62	32.3%	70	29.4%	100	32.1%	74	37.8%	92	43.6%	229	53.0%	91	48.7%	14	32.6%	787	39.0%
女性	28	37.8%	45	36.0%	54	29.5%	83	31.4%	140	40.5%	88	42.3%	108	48.9%	238	56.0%	136	49.1%	25	34.2%	945	43.0%
男女合計	52	33.3%	76	30.6%	116	30.9%	153	30.5%	240	36.5%	162	40.1%	200	46.3%	467	54.5%	227	48.9%	39	33.6%	1732	41.1%
全体(人)																						
男性	82		123		192		238		312		196		211		432		187		43		2016	
女性	74		125		183		264		346		208		221		425		277		73		2196	
男女合計	156		248		375		502		658		404		432		857		464		116		4212	

3. スポーツやランニングをしていると回答した人

	10	割合	20	割合	30	割合	40	割合	50	割合	64	割合	69	割合	70	割合	80	割合	90	割合	全体数	割合
3に○																						
男性	36	43.9%	34	27.6%	44	22.9%	51	21.4%	46	14.7%	25	12.8%	29	13.7%	77	17.8%	20	10.7%	0	0.0%	362	18.0%
女性	13	17.6%	16	12.8%	15	8.2%	27	10.2%	23	6.6%	17	8.2%	27	12.2%	36	8.5%	18	6.5%	4	5.5%	196	8.9%
男女合計	49	31.4%	50	20.2%	59	15.7%	78	15.5%	69	10.5%	42	10.4%	56	13.0%	113	13.2%	38	8.2%	4	3.4%	558	13.2%
全体(人)																						
男性	82		123		192		238		312		196		211		432		187		43		2016	
女性	74		125		183		264		346		208		221		425		277		73		2196	
男女合計	156		248		375		502		658		404		432		857		464		116		4212	

4. 休養や睡眠を十分とるようにしていると回答した人

	10	割合	20	割合	30	割合	40	割合	50	割合	64	割合	69	割合	70	割合	80	割合	90	割合	全体数	割合
4に○																						
男性	25	30.5%	47	38.2%	66	34.4%	91	38.2%	117	37.5%	78	39.8%	102	48.3%	247	57.2%	111	59.4%	25	58.1%	909	45.1%
女性	27	36.5%	60	48.0%	89	48.6%	125	47.3%	138	39.9%	94	45.2%	115	52.0%	239	56.2%	155	56.0%	26	35.6%	1068	48.6%
男女合計	52	33.3%	107	43.1%	155	41.3%	216	43.0%	255	38.8%	172	42.6%	217	50.2%	486	56.7%	266	57.3%	51	44.0%	1977	46.9%
全体(人)																						
男性	82		123		192		238		312		196		211		432		187		43		2016	
女性	74		125		183		264		346		208		221		425		277		73		2196	
男女合計	156		248		375		502		658		404		432		857		464		116		4212	

5. 酒を控えるようにしていると回答した人

	10	割合	20	割合	30	割合	40	割合	50	割合	64	割合	69	割合	70	割合	80	割合	90	割合	全体数	割合
5に○																						
男性	10	12.2%	40	32.5%	56	29.2%	59	24.8%	75	24.0%	40	20.4%	65	30.8%	168	38.9%	70	37.4%	13	30.2%	596	29.6%
女性	10	13.5%	42	33.6%	58	31.7%	68	25.8%	108	31.2%	70	33.7%	65	29.4%	127	29.9%	53	19.1%	10	13.7%	611	27.8%
男女合計	20	12.8%	82	33.1%	114	30.4%	127	25.3%	183	27.8%	110	27.2%	130	30.1%	295	34.4%	123	26.5%	23	19.8%	1207	28.7%
全体(人)																						
男性	82		123		192		238		312		196		211		432		187		43		2016	
女性	74		125		183		264		346		208		221		425		277		73		2196	
男女合計	156		248		375		502		658		404		432		857		464		116		4212	

6. たばこを吸わないようにしていると回答した人

	10	割合	20	割合	30	割合	40	割合	50	割合	64	割合	69	割合	70	割合	80	割合	90	割合	全体数	割合
6に○																						
男性	11	13.4%	55	44.7%	86	44.8%	99	41.6%	108	34.6%	74	37.8%	103	48.8%	213	49.3%	88	47.1%	16	37.2%	853	42.3%
女性	13	17.6%	52	41.6%	78	42.6%	99	37.5%	140	40.5%	89	42.8%	74	33.5%	147	34.6%	57	20.6%	10	13.7%	759	34.6%
男女合計	24	15.4%	107	43.1%	164	43.7%	198	39.4%	248	37.7%	163	40.3%	177	41.0%	360	42.0%	145	31.3%	26	22.4%	1612	38.3%
全体(人)																						
男性	82		123		192		238		312		196		211		432		187		43		2016	
女性	74		125		183		264		346		208		221		425		277		73		2196	
男女合計	156		248		375		502		658		404		432		857		464		116		4212	

7. 定期的に健康診断を受けるようにしていると回答した人

	10	割合	20	割合	30	割合	40	割合	50	割合	64	割合	69	割合	70	割合	80	割合	90	割合	全体数	割合
7に○																						
男性	4	4.9%	25	20.3%	63	32.8%	113	47.5%	147	47.1%	120	61.2%	125	59.2%	253	58.6%	99	52.9%	18	41.9%	967	48.0%
女性	6	8.1%	27	21.6%	64	35.0%	125	47.3%	160	46.2%	122	58.7%	129	58.4%	226	53.2%	131	47.3%	19	26.0%	1009	45.9%
男女合計	10	6.4%	52	21.0%	127	33.9%	238	47.4%	307	46.7%	242	59.9%	254	58.8%	479	55.9%	230	49.6%	37	31.9%	1976	46.9%
全体(人)																						
男性	82		123		192		238		312		196		211		432		187		43		2016	
女性	74		125		183		264		346		208		221		425		277		73		2196	
男女合計	156		248		375		502		658		404		432		857		464		116		4212	

8. 趣味や生きがいをもち、生活にメリハリを持たせようしていると回答した人

	10	割合	20	割合	30	割合	40	割合	50	割合	64	割合	69	割合	70	割合	80	割合	90	割合	全体数	割合
8に○																						
男性	14	17.1%	40	32.5%	53	27.6%	57	23.9%	83	26.6%	52	26.5%	72	34.1%	162	37.5%	60	32.1%	9	20.9%	602	29.9%
女性	26	35.1%	40	32.0%	44	24.0%	57	21.6%	89	25.7%	56	26.9%	89	40.3%	187	44.0%	94	33.9%	12	16.4%	694	31.6%
男女合計	40	25.6%	80	32.3%	97	25.9%	114	22.7%	172	26.1%	108	26.7%	161	37.3%	349	40.7%	154	33.2%	21	18.1%	1296	30.8%
全体(人)																						
男性	82		123		192		238		312		196		211		432		187		43		2016	
女性	74		125		183		264		346		208		221		425		277		73		2196	
男女合計	156		248		375		502		658		404		432		857		464		116		4212	

9. 健康補助食品などを利用していると回答した人

	10	割合	20	割合	30	割合	40	割合	50	割合	64	割合	69	割合	70	割合	80	割合	90	割合	全体数	割合
9に○																						
男性	7	8.5%	14	11.4%	28	14.6%	27	11.3%	54	17.3%	36	18.4%	45	21.3%	65	15.0%	32	17.1%	2	4.7%	310	15.4%
女性	8	10.8%	14	11.2%	35	19.1%	58	22.0%	77	22.3%	52	25.0%	53	24.0%	92	21.6%	61	22.0%	12	16.4%	462	21.0%
男女合計	15	9.6%	28	11.3%	63	16.8%	85	16.9%	131	19.9%	88	21.8%	98	22.7%	157	18.3%	93	20.0%	14	12.1%	772	18.3%
全体(人)																						
男性	82		123		192		238		312		196		211		432		187		43		2016	
女性	74		125		183		264		346		208		221		425		277		73		2196	
男女合計	156		248		375		502		658		404		432		857		464		116		4212	

10. その他と回答した人

	10	割合	20	割合	30	割合	40	割合	50	割合	64	割合	69	割合	70	割合	80	割合	90	割合	全体数	割合
10に○																						
男性	1	1.2%	1	0.8%	3	1.6%	3	1.3%	4	1.3%	3	1.5%	4	1.9%	23	5.3%	16	8.6%	3	7.0%	61	3.0%
女性	0	0.0%	1	0.8%	1	0.5%	1	0.4%	4	1.2%	4	1.9%	2	0.9%	20	4.7%	18	6.5%	4	5.5%	55	2.5%
男女合計	1	0.6%	2	0.8%	4	1.1%	4	0.8%	8	1.2%	7	1.7%	6	1.4%	43	5.0%	34	7.3%	7	6.0%	116	2.8%
全体(人)																						
男性	82		123		192		238		312		196		211		432		187		43		2016	
女性	74		125		183		264		346		208		221		425		277		73		2196	
男女合計	156		248		375		502		658		404		432		857		464		116		4212	

11. 特に何もしていないと回答した人

	10	割合	20	割合	30	割合	40	割合	50	割合	64	割合	69	割合	70	割合	80	割合	90	割合	全体数	割合
11に○																						
男性	14	17.1%	22	17.9%	36	18.8%	26	10.9%	45	14.4%	18	9.2%	15	7.1%	26	6.0%	12	6.4%	7	16.3%	221	11.0%
女性	16	21.6%	15	12.0%	29	15.8%	25	9.5%	35	10.1%	14	6.7%	10	4.5%	13	3.1%	22	7.9%	17	23.3%	196	8.9%
男女合計	30	19.2%	37	14.9%	65	17.3%	51	10.2%	80	12.2%	32	7.9%	25	5.8%	39	4.6%	34	7.3%	24	20.7%	417	9.9%
全体(人)																						
男性	82		123		192		238		312		196		211		432		187		43		2016	
女性	74		125		183		264		346		208		221		425		277		73		2196	
男女合計	156		248		375		502		658		404		432		857		464		116		4212	

3 「県民健康の日」の認知度（調査票 問3）

問3 あなたは、福島県において、10月10日が「県民健康の日」であることを知っていますか。

1 知っている 2 知らない

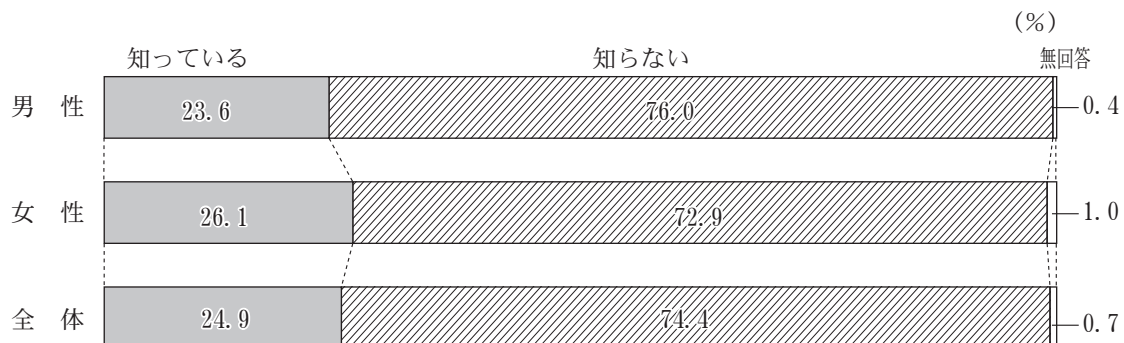

	10	割合	20	割合	30	割合	40	割合	50	割合	64	割合	69	割合	70	割合	80	割合	90	割合	全体数	割合
1と回答																						
男性	9	11.0%	14	11.4%	21	10.9%	40	16.8%	58	18.6%	39	19.9%	50	23.7%	162	37.5%	71	38.0%	11	25.6%	475	23.6%
女性	2	2.7%	19	15.2%	14	7.7%	35	13.3%	75	21.7%	49	23.6%	64	29.0%	174	40.9%	126	45.5%	15	20.5%	573	26.1%
男女合計	11	7.1%	33	13.3%	35	9.3%	75	14.9%	133	20.2%	88	21.8%	114	26.4%	336	39.2%	197	42.5%	26	22.4%	1048	24.9%
2と回答																						
男性	73	89.0%	109	88.6%	171	89.1%	197	82.8%	252	80.8%	157	80.1%	161	76.3%	268	62.0%	113	60.4%	31	72.1%	1532	76.0%
女性	72	97.3%	106	84.8%	169	92.3%	228	86.4%	270	78.0%	157	75.5%	155	70.1%	240	56.5%	146	52.7%	58	79.5%	1601	72.9%
男女合計	145	92.9%	215	86.7%	340	90.7%	425	84.7%	522	79.3%	314	77.7%	316	73.1%	508	59.3%	259	55.8%	89	76.7%	3133	74.4%
無回答																						
男性	0	0.0%	0	0.0%	0	0.0%	1	0.4%	2	0.6%	0	0.0%	0	0.0%	2	0.5%	3	1.6%	1	2.3%	9	0.4%
女性	0	0.0%	0	0.0%	0	0.0%	1	0.4%	1	0.3%	2	1.0%	2	0.9%	11	2.6%	5	1.8%	0	0.0%	22	1.0%
男女合計	0	0.0%	0	0.0%	0	0.0%	2	0.4%	3	0.5%	2	0.5%	2	0.5%	13	1.5%	8	1.7%	1	0.9%	31	0.7%
全体(人)																						
男性	82	123	192	238	312	196	211	432	187	43											2016	
女性	74	125	183	264	346	208	221	425	277	73											2196	
男女合計	156	248	375	502	658	404	432	857	464	116											4212	

県 北

	10	割合	20	割合	30	割合	40	割合	50	割合	64	割合	69	割合	70～	割合	全体数	割合
1と回答																		
男性	5	20.8%	0	0.0%	6	13.6%	8	14.0%	20	23.0%	13	26.5%	11	21.2%	54	38.3%	117	23.4%
女性	1	6.7%	10	22.2%	7	15.6%	12	17.4%	19	17.9%	11	25.0%	14	25.5%	75	39.7%	149	26.2%
男女合計	6	15.4%	10	10.9%	13	14.6%	20	15.9%	39	20.2%	24	25.8%	25	23.4%	129	39.1%	266	24.9%
2と回答																		
男性	19	79.2%	47	100.0%	38	86.4%	48	84.2%	67	77.0%	36	73.5%	41	78.8%	87	61.7%	383	76.4%
女性	14	93.3%	35	77.8%	38	84.4%	57	82.6%	87	82.1%	32	72.7%	41	74.5%	106	56.1%	410	72.2%
男女合計	33	84.6%	82	89.1%	76	85.4%	105	83.3%	154	79.8%	68	73.1%	82	76.6%	193	58.5%	793	74.2%
無回答																		
男性	0	0.0%	0	0.0%	0	0.0%	1	1.8%	0	0.0%	0	0.0%	0	0.0%	0	0.0%	1	0.2%
女性	0	0.0%	0	0.0%	0	0.0%	0	0.0%	0	0.0%	1	2.3%	0	0.0%	8	4.2%	9	1.6%
男女合計	0	0.0%	0	0.0%	0	0.0%	1	0.8%	0	0.0%	1	1.1%	0	0.0%	8	2.4%	10	0.9%
全体(人)																		
男性	24		47		44		57		87		49		52		141		501	
女性	15		45		45		69		106		44		55		189		568	
男女合計	39		92		89		126		193		93		107		330		1069	

県 中

	10	割合	20	割合	30	割合	40	割合	50	割合	64	割合	69	割合	70～	割合	全体数	割合
1と回答																		
男性	2	9.5%	5	15.6%	7	13.7%	9	13.6%	14	15.9%	12	25.5%	14	31.8%	47	32.9%	110	22.4%
女性	1	5.0%	2	5.4%	2	3.7%	5	6.8%	18	22.8%	12	24.0%	14	31.8%	56	35.4%	110	21.4%
男女合計	3	7.3%	7	10.1%	9	8.6%	14	10.1%	32	19.2%	24	24.7%	28	31.8%	103	34.2%	220	21.8%
2と回答																		
男性	19	90.5%	27	84.4%	44	86.3%	57	86.4%	72	81.8%	35	74.5%	30	68.2%	94	65.7%	378	76.8%
女性	19	95.0%	35	94.6%	52	96.3%	67	91.8%	60	75.9%	37	74.0%	30	68.2%	100	63.3%	400	77.7%
男女合計	38	92.7%	62	89.9%	96	91.4%	124	89.2%	132	79.0%	72	74.2%	60	68.2%	194	64.5%	778	77.3%
無回答																		
男性	0	0.0%	0	0.0%	0	0.0%	0	0.0%	2	2.3%	0	0.0%	0	0.0%	2	1.4%	4	0.8%
女性	0	0.0%	0	0.0%	0	0.0%	1	1.4%	1	1.3%	1	2.0%	0	0.0%	2	1.3%	5	1.0%
男女合計	0	0.0%	0	0.0%	0	0.0%	1	0.7%	3	1.8%	1	1.0%	0	0.0%	4	1.3%	9	0.9%
全体(人)																		
男性	21		32		51		66		88		47		44		143		492	
女性	20		37		54		73		79		50		44		158		515	
男女合計	41		69		105		139		167		97		88		301		1007	

県 南

	10	割合	20	割合	30	割合	40	割合	50	割合	64	割合	69	割合	70～	割合	全体数	割合
1と回答																		
男性	0	0.0%	0	0.0%	1	5.0%	4	19.0%	4	11.8%	4	19.0%	3	14.3%	29	36.7%	45	20.9%
女性	0	0.0%	0	0.0%	1	6.7%	3	10.7%	9	25.7%	7	26.9%	6	25.0%	41	42.3%	67	27.2%
男女合計	0	0.0%	0	0.0%	2	5.7%	7	14.3%	13	18.8%	11	23.4%	9	20.0%	70	39.8%	112	24.3%
2と回答																		
男性	12	100.0%	7	100.0%	19	95.0%	17	81.0%	30	88.2%	17	81.0%	18	85.7%	50	63.3%	170	79.1%
女性	10	100.0%	11	100.0%	14	93.3%	25	89.3%	26	74.3%	19	73.1%	17	70.8%	53	54.6%	175	71.1%
男女合計	22	100.0%	18	100.0%	33	94.3%	42	85.7%	56	81.2%	36	76.6%	35	77.8%	103	58.5%	345	74.8%
無回答																		
男性	0	0.0%	0	0.0%	0	0.0%	0	0.0%	0	0.0%	0	0.0%	0	0.0%	0	0.0%	0	0.0%
女性	0	0.0%	0	0.0%	0	0.0%	0	0.0%	0	0.0%	0	0.0%	1	4.2%	3	3.1%	4	1.6%
男女合計	0	0.0%	0	0.0%	0	0.0%	0	0.0%	0	0.0%	0	0.0%	1	2.2%	3	1.7%	4	0.9%
全体(人)																		
男性	12		7		20		21		34		21		21		79		215	
女性	10		11		15		28		35		26		24		97		246	
男女合計	22		18		35		49		69		47		45		176		461	

会 津

	10	割合	20	割合	30	割合	40	割合	50	割合	64	割合	69	割合	70～	割合	全体数	割合
1と回答																		
男性	0	0.0%	3	16.7%	2	7.1%	11	25.6%	5	15.6%	4	18.2%	5	20.0%	42	42.4%	72	26.4%
女性	0	0.0%	0	0.0%	1	4.0%	5	13.2%	9	21.4%	6	21.4%	14	43.8%	49	41.9%	84	28.0%
男女合計	0	0.0%	3	10.3%	3	5.7%	16	19.8%	14	18.9%	10	20.0%	19	33.3%	91	42.1%	156	27.2%
2と回答																		
男性	6	100.0%	15	83.3%	26	92.9%	32	74.4%	27	84.4%	18	81.8%	20	80.0%	56	56.6%	200	73.3%
女性	7	100.0%	11	100.0%	24	96.0%	33	86.8%	33	78.6%	22	78.6%	17	53.1%	66	56.4%	213	71.0%
男女合計	13	100.0%	26	89.7%	50	94.3%	65	80.2%	60	81.1%	40	80.0%	37	64.9%	122	56.5%	413	72.1%
無回答																		
男性	0	0.0%	0	0.0%	0	0.0%	0	0.0%	0	0.0%	0	0.0%	0	0.0%	1	1.0%	1	0.4%
女性	0	0.0%	0	0.0%	0	0.0%	0	0.0%	0	0.0%	0	0.0%	1	3.1%	2	1.7%	3	1.0%
男女合計	0	0.0%	0	0.0%	0	0.0%	0	0.0%	0	0.0%	0	0.0%	1	1.8%	3	1.4%	4	0.7%
全体(人)																		
男性	6		18		28		43		32		22		25		99		273	
女性	7		11		25		38		42		28		32		117		300	
男女合計	13		29		53		81		74		50		57		216		573	

南会津

	10	割合	20	割合	30	割合	40	割合	50	割合	64	割合	69	割合	70～	割合	全体数	割合
1と回答																		
男性	0	0.0%	1	33.3%	0	0.0%	0	0.0%	2	66.7%	0	0.0%	1	25.0%	3	21.4%	7	23.3%
女性	0	0.0%	0	0.0%	0	0.0%	0	0.0%	0	0.0%	1	33.3%	0	0.0%	6	46.2%	7	26.9%
男女合計	0	0.0%	1	33.3%	0	0.0%	0	0.0%	2	50.0%	1	25.0%	1	12.5%	9	33.3%	14	25.0%
2と回答																		
男性	0	0.0%	2	66.7%	2	100.0%	3	100.0%	1	33.3%	1	100.0%	3	75.0%	11	78.6%	23	76.7%
女性	0	0.0%	0	0.0%	2	100.0%	3	100.0%	1	100.0%	2	66.7%	4	100.0%	7	53.8%	19	73.1%
男女合計	0	0.0%	2	66.7%	4	100.0%	6	100.0%	2	50.0%	3	75.0%	7	87.5%	18	66.7%	42	75.0%
無回答																		
男性	0	0.0%	0	0.0%	0	0.0%	0	0.0%	0	0.0%	0	0.0%	0	0.0%	0	0.0%	0	0.0%
女性	0	0.0%	0	0.0%	0	0.0%	0	0.0%	0	0.0%	0	0.0%	0	0.0%	0	0.0%	0	0.0%
男女合計	0	0.0%	0	0.0%	0	0.0%	0	0.0%	0	0.0%	0	0.0%	0	0.0%	0	0.0%	0	0.0%
全体(人)																		
男性	0		3		2		3		3		1		4		14		30	
女性	0		0		2		3		1		3		4		13		26	
男女合計	0		3		4		6		4		4		8		27		56	

相 双

	10	割合	20	割合	30	割合	40	割合	50	割合	64	割合	69	割合	70～	割合	全体数	割合
1と回答																		
男性	2	33.3%	3	50.0%	3	25.0%	2	11.1%	4	20.0%	3	21.4%	4	20.0%	26	45.6%	47	30.7%
女性	0	0.0%	0	0.0%	1	7.1%	5	20.8%	5	25.0%	1	9.1%	8	42.1%	37	61.7%	57	36.1%
男女合計	2	16.7%	3	30.0%	4	15.4%	7	16.7%	9	22.5%	4	16.0%	12	30.8%	63	53.8%	104	33.4%
2と回答																		
男性	4	66.7%	3	50.0%	9	75.0%	16	88.9%	16	80.0%	11	78.6%	16	80.0%	30	52.6%	105	68.6%
女性	6	100.0%	4	100.0%	13	92.9%	19	79.2%	15	75.0%	10	90.9%	11	57.9%	23	38.3%	101	63.9%
男女合計	10	83.3%	7	70.0%	22	84.6%	35	83.3%	31	77.5%	21	84.0%	27	69.2%	53	45.3%	206	66.2%
無回答																		
男性	0	0.0%	0	0.0%	0	0.0%	0	0.0%	0	0.0%	0	0.0%	0	0.0%	1	1.8%	1	0.7%
女性	0	0.0%	0	0.0%	0	0.0%	0	0.0%	0	0.0%	0	0.0%	0	0.0%	0	0.0%	0	0.0%
男女合計	0	0.0%	0	0.0%	0	0.0%	0	0.0%	0	0.0%	0	0.0%	0	0.0%	1	0.9%	1	0.3%
全体(人)																		
男性	6		6		12		18		20		14		20		57		153	
女性	6		4		14		24		20		11		19		60		158	
男女合計	12		10		26		42		40		25		39		117		311	

いわき

	10	割合	20	割合	30	割合	40	割合	50	割合	64	割合	69	割合	70～	割合	全体数	割合
1と回答																		
男性	0	0.0%	2	20.0%	2	5.7%	6	20.0%	9	18.8%	3	7.1%	12	26.7%	43	33.3%	77	21.9%
女性	0	0.0%	7	41.2%	2	7.1%	5	17.2%	15	23.8%	11	23.9%	8	18.6%	51	36.2%	99	25.8%
男女合計	0	0.0%	9	33.3%	4	6.3%	11	18.6%	24	21.6%	14	15.9%	20	22.7%	94	34.8%	176	23.9%
2と回答																		
男性	13	100.0%	8	80.0%	33	94.3%	24	80.0%	39	81.3%	39	92.9%	33	73.3%	84	65.1%	273	77.6%
女性	16	100.0%	10	58.8%	26	92.9%	24	82.8%	48	76.2%	35	76.1%	35	81.4%	89	63.1%	283	73.9%
男女合計	29	100.0%	18	66.7%	59	93.7%	48	81.4%	87	78.4%	74	84.1%	68	77.3%	173	64.1%	556	75.6%
無回答																		
男性	0	0.0%	0	0.0%	0	0.0%	0	0.0%	0	0.0%	0	0.0%	0	0.0%	2	1.6%	2	0.6%
女性	0	0.0%	0	0.0%	0	0.0%	0	0.0%	0	0.0%	0	0.0%	0	0.0%	1	0.7%	1	0.3%
男女合計	0	0.0%	0	0.0%	0	0.0%	0	0.0%	0	0.0%	0	0.0%	0	0.0%	3	1.1%	3	0.4%
全体(人)																		
男性	13		10		35		30		48		42		45		129		352	
女性	16		17		28		29		63		46		43		141		383	
男女合計	29		27		63		59		111		88		88		270		735	

全県(60歳以上・再掲)

	64	割合	69	割合	70	割合	80	割合	90	割合	全体数	割合
1と回答												
男性	39	19.9%	50	23.7%	162	37.5%	71	38.0%	11	25.6%	333	31.2%
女性	49	23.6%	64	29.0%	174	40.9%	126	45.5%	15	20.5%	428	35.5%
男女合計	88	21.8%	114	26.4%	336	39.2%	197	42.5%	26	22.4%	761	33.5%
2と回答												
男性	157	80.1%	161	76.3%	268	62.0%	113	60.4%	31	72.1%	730	68.3%
女性	157	75.5%	155	70.1%	240	56.5%	146	52.7%	58	79.5%	756	62.8%
男女合計	314	77.7%	316	73.1%	508	59.3%	259	55.8%	89	76.7%	1486	65.4%
無回答												
男性	0	0.0%	0	0.0%	2	0.5%	3	1.6%	1	2.3%	6	0.6%
女性	2	1.0%	2	0.9%	11	2.6%	5	1.8%	0	0.0%	20	1.7%
男女合計	2	0.5%	2	0.5%	13	1.5%	8	1.7%	1	0.9%	26	1.1%
全体(人)												
男性	196		211		432		187		43		1069	
女性	208		221		425		277		73		1204	
男女合計	404		432		857		464		116		2273	

4 食生活（朝食）の状況（調査票 問4）

問4 あなたは、朝食をだいたい毎日とっていますか。

1 はい 2 いいえ

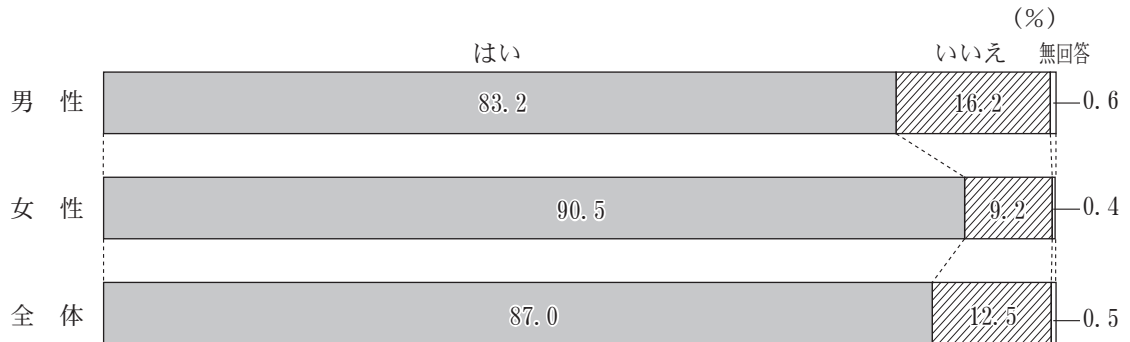

	10	割合	20	割合	30	割合	40	割合	50	割合	64	割合	69	割合	70	割合	80	割合	90	割合	全体数	割合
1と回答																						
男性	63	76.8%	74	60.2%	127	66.1%	180	75.6%	235	75.3%	174	88.8%	190	90.0%	411	95.1%	183	97.9%	40	93.0%	1677	83.2%
女性	66	89.2%	97	77.6%	149	81.4%	217	82.2%	314	90.8%	187	89.9%	207	93.7%	409	96.2%	269	97.1%	72	98.6%	1987	90.5%
男女合計	129	82.7%	171	69.0%	276	73.6%	397	79.1%	549	83.4%	361	89.4%	397	91.9%	820	95.7%	452	97.4%	112	96.6%	3664	87.0%
2と回答																						
男性	19	23.2%	49	39.8%	64	33.3%	56	23.5%	73	23.4%	22	11.2%	20	9.5%	18	4.2%	4	2.1%	1	2.3%	326	16.2%
女性	8	10.8%	28	22.4%	34	18.6%	47	17.8%	32	9.2%	20	9.6%	14	6.3%	13	3.1%	4	1.4%	1	1.4%	201	9.2%
男女合計	27	17.3%	77	31.0%	98	26.1%	103	20.5%	105	16.0%	42	10.4%	34	7.9%	31	3.6%	8	1.7%	2	1.7%	527	12.5%
無回答																						
男性	0	0.0%	0	0.0%	1	0.5%	2	0.8%	4	1.3%	0	0.0%	1	0.5%	3	0.7%	0	0.0%	2	4.7%	13	0.6%
女性	0	0.0%	0	0.0%	0	0.0%	0	0.0%	0	0.0%	1	0.5%	0	0.0%	3	0.7%	4	1.4%	0	0.0%	8	0.4%
男女合計	0	0.0%	0	0.0%	1	0.3%	2	0.4%	4	0.6%	1	0.2%	1	0.2%	6	0.7%	4	0.9%	2	1.7%	21	0.5%
全体(人)																						
男性	82	123	192	238	312	196	211	432	187	43											2016	
女性	74	125	183	264	346	208	221	425	277	73											2196	
男女合計	156	248	375	502	658	404	432	857	464	116											4212	

県 北

	10	割合	20	割合	30	割合	40	割合	50	割合	64	割合	69	割合	70～	割合	全体数	割合
1と回答																		
男性	19	79.2%	31	66.0%	32	72.7%	39	68.4%	72	82.8%	44	89.8%	48	92.3%	136	96.5%	421	84.0%
女性	14	93.3%	36	80.0%	40	88.9%	60	87.0%	95	89.6%	39	88.6%	53	96.4%	179	94.7%	516	90.8%
男女合計	33	84.6%	67	72.8%	72	80.9%	99	78.6%	167	86.5%	83	89.2%	101	94.4%	315	95.5%	937	87.7%
2と回答																		
男性	5	20.8%	16	34.0%	11	25.0%	17	29.8%	15	17.2%	5	10.2%	3	5.8%	4	2.8%	76	15.2%
女性	1	6.7%	9	20.0%	5	11.1%	9	13.0%	11	10.4%	4	9.1%	2	3.6%	8	4.2%	49	8.6%
男女合計	6	15.4%	25	27.2%	16	18.0%	26	20.6%	26	13.5%	9	9.7%	5	4.7%	12	3.6%	125	11.7%
無回答																		
男性	0	0.0%	0	0.0%	1	2.3%	1	1.8%	0	0.0%	0	0.0%	1	1.9%	1	0.7%	4	0.8%
女性	0	0.0%	0	0.0%	0	0.0%	0	0.0%	0	0.0%	1	2.3%	0	0.0%	2	1.1%	3	0.5%
男女合計	0	0.0%	0	0.0%	1	1.1%	1	0.8%	0	0.0%	1	1.1%	1	0.9%	3	0.9%	7	0.7%
全体(人)																		
男性	24		47		44		57		87		49		52		141		501	
女性	15		45		45		69		106		44		55		189		568	
男女合計	39		92		89		126		193		93		107		330		1069	

県 中

	10	割合	20	割合	30	割合	40	割合	50	割合	64	割合	69	割合	70～	割合	全体数	割合
1と回答																		
男性	18	85.7%	18	56.3%	36	70.6%	50	75.8%	61	69.3%	44	93.6%	40	90.9%	134	93.7%	401	81.5%
女性	18	90.0%	28	75.7%	44	81.5%	54	74.0%	73	92.4%	45	90.0%	43	97.7%	151	95.6%	456	88.5%
男女合計	36	87.8%	46	66.7%	80	76.2%	104	74.8%	134	80.2%	89	91.8%	83	94.3%	285	94.7%	857	85.1%
2と回答																		
男性	3	14.3%	14	43.8%	15	29.4%	15	22.7%	25	28.4%	3	6.4%	4	9.1%	8	5.6%	87	17.7%
女性	2	10.0%	9	24.3%	10	18.5%	19	26.0%	6	7.6%	5	10.0%	1	2.3%	5	3.2%	57	11.1%
男女合計	5	12.2%	23	33.3%	25	23.8%	34	24.5%	31	18.6%	8	8.2%	5	5.7%	13	4.3%	144	14.3%
無回答																		
男性	0	0.0%	0	0.0%	0	0.0%	1	1.5%	2	2.3%	0	0.0%	0	0.0%	1	0.7%	4	0.8%
女性	0	0.0%	0	0.0%	0	0.0%	0	0.0%	0	0.0%	0	0.0%	0	0.0%	2	1.3%	2	0.4%
男女合計	0	0.0%	0	0.0%	0	0.0%	1	0.7%	2	1.2%	0	0.0%	0	0.0%	3	1.0%	6	0.6%
全体(人)																		
男性	21		32		51		66		88		47		44		143		492	
女性	20		37		54		73		79		50		44		158		515	
男女合計	41		69		105		139		167		97		88		301		1007	

県 南

	10	割合	20	割合	30	割合	40	割合	50	割合	64	割合	69	割合	70～	割合	全体数	割合
1と回答																		
男性	8	66.7%	4	57.1%	10	50.0%	17	81.0%	23	67.6%	18	85.7%	19	90.5%	72	91.1%	171	79.5%
女性	9	90.0%	8	72.7%	9	60.0%	23	82.1%	32	91.4%	21	80.8%	24	100.0%	95	97.9%	221	89.8%
男女合計	17	77.3%	12	66.7%	19	54.3%	40	81.6%	55	79.7%	39	83.0%	43	95.6%	167	94.9%	392	85.0%
2と回答																		
男性	4	33.3%	3	42.9%	10	50.0%	4	19.0%	10	29.4%	3	14.3%	2	9.5%	6	7.6%	42	19.5%
女性	1	10.0%	3	27.3%	6	40.0%	5	17.9%	3	8.6%	5	19.2%	0	0.0%	1	1.0%	24	9.8%
男女合計	5	22.7%	6	33.3%	16	45.7%	9	18.4%	13	18.8%	8	17.0%	2	4.4%	7	4.0%	66	14.3%
無回答																		
男性	0	0.0%	0	0.0%	0	0.0%	0	0.0%	1	2.9%	0	0.0%	0	0.0%	1	1.3%	2	0.9%
女性	0	0.0%	0	0.0%	0	0.0%	0	0.0%	0	0.0%	0	0.0%	0	0.0%	1	1.0%	1	0.4%
男女合計	0	0.0%	0	0.0%	0	0.0%	0	0.0%	1	1.4%	0	0.0%	0	0.0%	2	1.1%	3	0.7%
全体(人)																		
男性	12		7		20		21		34		21		21		79		215	
女性	10		11		15		28		35		26		24		97		246	
男女合計	22		18		35		49		69		47		45		176		461	

会 津

	10	割合	20	割合	30	割合	40	割合	50	割合	64	割合	69	割合	70～	割合	全体数	割合
1と回答																		
男性	2	33.3%	11	61.1%	20	71.4%	33	76.7%	23	71.9%	19	86.4%	24	96.0%	97	98.0%	229	83.9%
女性	6	85.7%	9	81.8%	20	80.0%	30	78.9%	40	95.2%	27	96.4%	28	87.5%	116	99.1%	276	92.0%
男女合計	8	61.5%	20	69.0%	40	75.5%	63	77.8%	63	85.1%	46	92.0%	52	91.2%	213	98.6%	505	88.1%
2と回答																		
男性	4	66.7%	7	38.9%	8	28.6%	10	23.3%	9	28.1%	3	13.6%	1	4.0%	2	2.0%	44	16.1%
女性	1	14.3%	2	18.2%	5	20.0%	8	21.1%	2	4.8%	1	3.6%	4	12.5%	0	0.0%	23	7.7%
男女合計	5	38.5%	9	31.0%	13	24.5%	18	22.2%	11	14.9%	4	8.0%	5	8.8%	2	0.9%	67	11.7%
無回答																		
男性	0	0.0%	0	0.0%	0	0.0%	0	0.0%	0	0.0%	0	0.0%	0	0.0%	0	0.0%	0	0.0%
女性	0	0.0%	0	0.0%	0	0.0%	0	0.0%	0	0.0%	0	0.0%	0	0.0%	1	0.9%	1	0.3%
男女合計	0	0.0%	0	0.0%	0	0.0%	0	0.0%	0	0.0%	0	0.0%	0	0.0%	1	0.5%	1	0.2%
全体(人)																		
男性	6		18		28		43		32		22		25		99		273	
女性	7		11		25		38		42		28		32		117		300	
男女合計	13		29		53		81		74		50		57		216		573	

南会津

	10	割合	20	割合	30	割合	40	割合	50	割合	64	割合	69	割合	70～	割合	全体数	割合
1と回答																		
男性	0	0.0%	1	33.3%	1	50.0%	1	33.3%	3	100.0%	1	100.0%	4	100.0%	14	100.0%	25	83.3%
女性	0	0.0%	0	0.0%	2	100.0%	3	100.0%	1	100.0%	3	100.0%	4	100.0%	13	100.0%	26	100.0%
男女合計	0	0.0%	1	33.3%	3	75.0%	4	66.7%	4	100.0%	4	100.0%	8	100.0%	27	100.0%	51	91.1%
2と回答																		
男性	0	0.0%	2	66.7%	1	50.0%	2	66.7%	0	0.0%	0	0.0%	0	0.0%	0	0.0%	5	16.7%
女性	0	0.0%	0	0.0%	0	0.0%	0	0.0%	0	0.0%	0	0.0%	0	0.0%	0	0.0%	0	0.0%
男女合計	0	0.0%	2	66.7%	1	25.0%	2	33.3%	0	0.0%	0	0.0%	0	0.0%	0	0.0%	5	8.9%
無回答																		
男性	0	0.0%	0	0.0%	0	0.0%	0	0.0%	0	0.0%	0	0.0%	0	0.0%	0	0.0%	0	0.0%
女性	0	0.0%	0	0.0%	0	0.0%	0	0.0%	0	0.0%	0	0.0%	0	0.0%	0	0.0%	0	0.0%
男女合計	0	0.0%	0	0.0%	0	0.0%	0	0.0%	0	0.0%	0	0.0%	0	0.0%	0	0.0%	0	0.0%
全体(人)																		
男性	0		3		2		3		3		1		4		14		30	
女性	0		0		2		3		1		3		4		13		26	
男女合計	0		3		4		6		4		4		8		27		56	

相 双

	10	割合	20	割合	30	割合	40	割合	50	割合	64	割合	69	割合	70～	割合	全体数	割合
1と回答																		
男性	6	100.0%	5	83.3%	9	75.0%	14	77.8%	16	80.0%	11	78.6%	16	80.0%	56	98.2%	133	86.9%
女性	5	83.3%	3	75.0%	10	71.4%	21	87.5%	16	80.0%	10	90.9%	17	89.5%	59	98.3%	141	89.2%
男女合計	11	91.7%	8	80.0%	19	73.1%	35	83.3%	32	80.0%	21	84.0%	33	84.6%	115	98.3%	274	88.1%
2と回答																		
男性	0	0.0%	1	16.7%	3	25.0%	4	22.2%	4	20.0%	3	21.4%	4	20.0%	0	0.0%	19	12.4%
女性	1	16.7%	1	25.0%	4	28.6%	3	12.5%	4	20.0%	1	9.1%	2	10.5%	1	1.7%	17	10.8%
男女合計	1	8.3%	2	20.0%	7	26.9%	7	16.7%	8	20.0%	4	16.0%	6	15.4%	1	0.9%	36	11.6%
無回答																		
男性	0	0.0%	0	0.0%	0	0.0%	0	0.0%	0	0.0%	0	0.0%	0	0.0%	1	1.8%	1	0.7%
女性	0	0.0%	0	0.0%	0	0.0%	0	0.0%	0	0.0%	0	0.0%	0	0.0%	0	0.0%	0	0.0%
男女合計	0	0.0%	0	0.0%	0	0.0%	0	0.0%	0	0.0%	0	0.0%	0	0.0%	1	0.9%	1	0.3%
全体(人)																		
男性	6		6		12		18		20		14		20		57		153	
女性	6		4		14		24		20		11		19		60		158	
男女合計	12		10		26		42		40		25		39		117		311	

いわき

	10	割合	20	割合	30	割合	40	割合	50	割合	64	割合	69	割合	70～	割合	全体数	割合
1と回答																		
男性	10	76.9%	4	40.0%	19	54.3%	26	86.7%	37	77.1%	37	88.1%	39	86.7%	125	96.9%	297	84.4%
女性	14	87.5%	13	76.5%	24	85.7%	26	89.7%	57	90.5%	42	91.3%	38	88.4%	137	97.2%	351	91.6%
男女合計	24	82.8%	17	63.0%	43	68.3%	52	88.1%	94	84.7%	79	89.8%	77	87.5%	262	97.0%	648	88.2%
2と回答																		
男性	3	23.1%	6	60.0%	16	45.7%	4	13.3%	10	20.8%	5	11.9%	6	13.3%	3	2.3%	53	15.1%
女性	2	12.5%	4	23.5%	4	14.3%	3	10.3%	6	9.5%	4	8.7%	5	11.6%	3	2.1%	31	8.1%
男女合計	5	17.2%	10	37.0%	20	31.7%	7	11.9%	16	14.4%	9	10.2%	11	12.5%	6	2.2%	84	11.4%
無回答																		
男性	0	0.0%	0	0.0%	0	0.0%	0	0.0%	1	2.1%	0	0.0%	0	0.0%	1	0.8%	2	0.6%
女性	0	0.0%	0	0.0%	0	0.0%	0	0.0%	0	0.0%	0	0.0%	0	0.0%	1	0.7%	1	0.3%
男女合計	0	0.0%	0	0.0%	0	0.0%	0	0.0%	1	0.9%	0	0.0%	0	0.0%	2	0.7%	3	0.4%
全体(人)																		
男性	13		10		35		30		48		42		45		129		352	
女性	16		17		28		29		63		46		43		141		383	
男女合計	29		27		63		59		111		88		88		270		735	

全県(60歳以上・再掲)

	64	割合	69	割合	70	割合	80	割合	90	割合	全体数	割合
1と回答												
男性	174	88.8%	190	90.0%	411	95.1%	183	97.9%	40	93.0%	998	93.4%
女性	187	89.9%	207	93.7%	409	96.2%	269	97.1%	72	98.6%	1144	95.0%
男女合計	361	89.4%	397	91.9%	820	95.7%	452	97.4%	112	96.6%	2142	94.2%
2と回答												
男性	22	11.2%	20	9.5%	18	4.2%	4	2.1%	1	2.3%	65	6.1%
女性	20	9.6%	14	6.3%	13	3.1%	4	1.4%	1	1.4%	52	4.3%
男女合計	42	10.4%	34	7.9%	31	3.6%	8	1.7%	2	1.7%	117	5.1%
無回答												
男性	0	0.0%	1	0.5%	3	0.7%	0	0.0%	2	4.7%	6	0.6%
女性	1	0.5%	0	0.0%	3	0.7%	4	1.4%	0	0.0%	8	0.7%
男女合計	1	0.2%	1	0.2%	6	0.7%	4	0.9%	2	1.7%	14	0.6%
全体(人)												
男性	196		211		432		187		43		1069	
女性	208		221		425		277		73		1204	
男女合計	404		432		857		464		116		2273	

5 食生活（朝食・夕食）の状況（調査票 問5）

問5 あなたは、朝食を家族とどのくらい一緒に食べていますか。（あてはまる番号1つに○）

- 1 ほとんど毎日 2 週に4～5日 3 週に2～3日
4 週に1日程度 5 ほとんどない

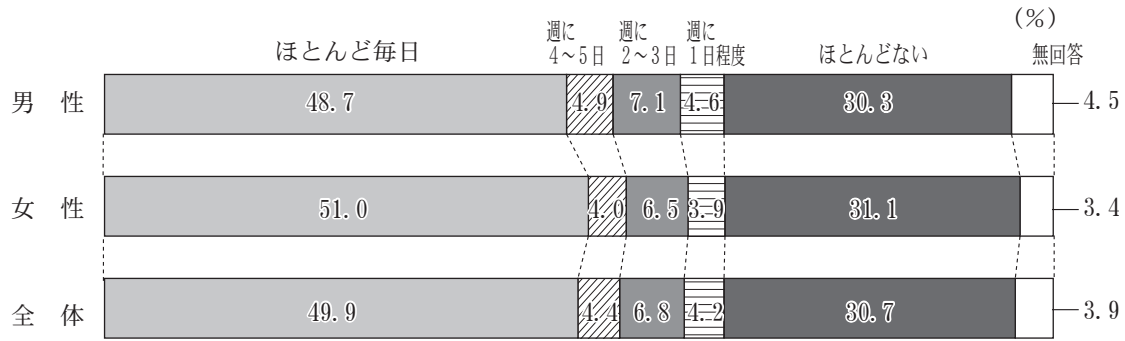

	10	割合	20	割合	30	割合	40	割合	50	割合	64	割合	69	割合	70	割合	80	割合	90	割合	全体数	割合
1と回答																						
男性	36	43.9%	29	23.6%	67	34.9%	79	33.2%	105	33.7%	93	47.4%	129	61.1%	277	64.1%	142	75.9%	24	55.8%	981	48.7%
女性	29	39.2%	36	28.8%	87	47.5%	111	42.0%	152	43.9%	106	51.0%	137	62.0%	267	62.8%	157	56.7%	39	53.4%	1121	51.0%
男女合計	65	41.7%	65	26.2%	154	41.1%	190	37.8%	257	39.1%	199	49.3%	266	61.6%	544	63.5%	299	64.4%	63	54.3%	2102	49.9%
2と回答																						
男性	9	11.0%	9	7.3%	13	6.8%	17	7.1%	15	4.8%	8	4.1%	9	4.3%	13	3.0%	4	2.1%	1	2.3%	98	4.9%
女性	7	9.5%	8	6.4%	8	4.4%	13	4.9%	21	6.1%	9	4.3%	7	3.2%	8	1.9%	5	1.8%	1	1.4%	87	4.0%
男女合計	16	10.3%	17	6.9%	21	5.6%	30	6.0%	36	5.5%	17	4.2%	16	3.7%	21	2.5%	9	1.9%	2	1.7%	185	4.4%
3と回答																						
男性	2	2.4%	16	13.0%	16	8.3%	31	13.0%	29	9.3%	15	7.7%	11	5.2%	18	4.2%	4	2.1%	2	4.7%	144	7.1%
女性	5	6.8%	13	10.4%	21	11.5%	28	10.6%	28	8.1%	16	7.7%	8	3.6%	12	2.8%	7	2.5%	5	6.8%	143	6.5%
男女合計	7	4.5%	29	11.7%	37	9.9%	59	11.8%	57	8.7%	31	7.7%	19	4.4%	30	3.5%	11	2.4%	7	6.0%	287	6.8%
4と回答																						
男性	4	4.9%	5	4.1%	13	6.8%	16	6.7%	24	7.7%	17	8.7%	5	2.4%	7	1.6%	1	0.5%	0	0.0%	92	4.6%
女性	5	6.8%	3	2.4%	12	6.6%	17	6.4%	19	5.5%	12	5.8%	3	1.4%	11	2.6%	3	1.1%	1	1.4%	86	3.9%
男女合計	9	5.8%	8	3.2%	25	6.7%	33	6.6%	43	6.5%	29	7.2%	8	1.9%	18	2.1%	4	0.9%	1	0.9%	178	4.2%
5と回答																						
男性	26	31.7%	55	44.7%	70	36.5%	87	36.6%	117	37.5%	60	30.6%	50	23.7%	102	23.6%	31	16.6%	13	30.2%	611	30.3%
女性	28	37.8%	60	48.0%	50	27.3%	86	32.6%	114	32.9%	58	27.9%	57	25.8%	119	28.0%	88	31.8%	24	32.9%	684	31.1%
男女合計	54	34.6%	115	46.4%	120	32.0%	173	34.5%	231	35.1%	118	29.2%	107	24.8%	221	25.8%	119	25.6%	37	31.9%	1295	30.7%
無回答																						
男性	5	6.1%	9	7.3%	13	6.8%	8	3.4%	22	7.1%	3	1.5%	7	3.3%	15	3.5%	5	2.7%	3	7.0%	90	4.5%
女性	0	0.0%	5	4.0%	5	2.7%	9	3.4%	12	3.5%	7	3.4%	9	4.1%	8	1.9%	17	6.1%	3	4.1%	75	3.4%
男女合計	5	3.2%	14	5.6%	18	4.8%	17	3.4%	34	5.2%	10	2.5%	16	3.7%	23	2.7%	22	4.7%	6	5.2%	165	3.9%
全体(人)																						
男性	82		123		192		238		312		196		211		432		187		43	2016		
女性	74		125		183		264		346		208		221		425		277		73	2196		
男女合計	156		248		375		502		658		404		432		857		464		116	4212		

県 北

	10	割合	20	割合	30	割合	40	割合	50	割合	64	割合	69	割合	70～	割合	全体数	割合
1と回答																		
男性	7	29.2%	11	23.4%	17	38.6%	15	26.3%	32	36.8%	20	40.8%	34	65.4%	88	62.4%	224	44.7%
女性	4	26.7%	10	22.2%	22	48.9%	31	44.9%	42	39.6%	21	47.7%	30	54.5%	107	56.6%	267	47.0%
男女合計	11	28.2%	21	22.8%	39	43.8%	46	36.5%	74	38.3%	41	44.1%	64	59.8%	195	59.1%	491	45.9%
2と回答																		
男性	1	4.2%	4	8.5%	2	4.5%	5	8.8%	4	4.6%	4	8.2%	0	0.0%	5	3.5%	25	5.0%
女性	2	13.3%	5	11.1%	1	2.2%	2	2.9%	7	6.6%	1	2.3%	4	7.3%	4	2.1%	26	4.6%
男女合計	3	7.7%	9	9.8%	3	3.4%	7	5.6%	11	5.7%	5	5.4%	4	3.7%	9	2.7%	51	4.8%
3と回答																		
男性	2	8.3%	6	12.8%	2	4.5%	5	8.8%	7	8.0%	3	6.1%	3	5.8%	6	4.3%	34	6.8%
女性	2	13.3%	8	17.8%	6	13.3%	4	5.8%	10	9.4%	3	6.8%	1	1.8%	9	4.8%	43	7.6%
男女合計	4	10.3%	14	15.2%	8	9.0%	9	7.1%	17	8.8%	6	6.5%	4	3.7%	15	4.5%	77	7.2%
4と回答																		
男性	1	4.2%	0	0.0%	4	9.1%	5	8.8%	4	4.6%	6	12.2%	2	3.8%	1	0.7%	23	4.6%
女性	2	13.3%	2	4.4%	3	6.7%	6	8.7%	8	7.5%	0	0.0%	1	1.8%	2	1.1%	24	4.2%
男女合計	3	7.7%	2	2.2%	7	7.9%	11	8.7%	12	6.2%	6	6.5%	3	2.8%	3	0.9%	47	4.4%
5と回答																		
男性	11	45.8%	24	51.1%	17	38.6%	24	42.1%	37	42.5%	16	32.7%	12	23.1%	40	28.4%	181	36.1%
女性	5	33.3%	18	40.0%	12	26.7%	25	36.2%	34	32.1%	17	38.6%	15	27.3%	62	32.8%	188	33.1%
男女合計	16	41.0%	42	45.7%	29	32.6%	49	38.9%	71	36.8%	33	35.5%	27	25.2%	102	30.9%	369	34.5%
無回答																		
男性	2	8.3%	2	4.3%	2	4.5%	3	5.3%	3	3.4%	0	0.0%	1	1.9%	1	0.7%	14	2.8%
女性	0	0.0%	2	4.4%	1	2.2%	1	1.4%	5	4.7%	2	4.5%	4	7.3%	5	2.6%	20	3.5%
男女合計	2	5.1%	4	4.3%	3	3.4%	4	3.2%	8	4.1%	2	2.2%	5	4.7%	6	1.8%	34	3.2%
全体(人)																		
男性	24		47		44		57		87		49		52		141		501	
女性	15		45		45		69		106		44		55		189		568	
男女合計	39		92		89		126		193		93		107		330		1069	

県 中

	10	割合	20	割合	30	割合	40	割合	50	割合	64	割合	69	割合	70～	割合	全体数	割合
1と回答																		
男性	13	61.9%	8	25.0%	27	52.9%	21	31.8%	21	23.9%	31	66.0%	25	56.8%	93	65.0%	239	48.6%
女性	6	30.0%	14	37.8%	28	51.9%	28	38.4%	36	45.6%	22	44.0%	31	70.5%	82	51.9%	247	48.0%
男女合計	19	46.3%	22	31.9%	55	52.4%	49	35.3%	57	34.1%	53	54.6%	56	63.6%	175	58.1%	486	48.3%
2と回答																		
男性	4	19.0%	1	3.1%	5	9.8%	5	7.6%	3	3.4%	1	2.1%	3	6.8%	5	3.5%	27	5.5%
女性	1	5.0%	2	5.4%	2	3.7%	3	4.1%	4	5.1%	3	6.0%	1	2.3%	0	0.0%	16	3.1%
男女合計	5	12.2%	3	4.3%	7	6.7%	8	5.8%	7	4.2%	4	4.1%	4	4.5%	5	1.7%	43	4.3%
3と回答																		
男性	0	0.0%	5	15.6%	4	7.8%	12	18.2%	9	10.2%	3	6.4%	2	4.5%	8	5.6%	43	8.7%
女性	0	0.0%	2	5.4%	3	5.6%	10	13.7%	6	7.6%	1	2.0%	1	2.3%	7	4.4%	30	5.8%
男女合計	0	0.0%	7	10.1%	7	6.7%	22	15.8%	15	9.0%	4	4.1%	3	3.4%	15	5.0%	73	7.2%
4と回答																		
男性	1	4.8%	2	6.3%	1	2.0%	1	1.5%	13	14.8%	1	2.1%	2	4.5%	2	1.4%	23	4.7%
女性	2	10.0%	0	0.0%	5	9.3%	4	5.5%	5	6.3%	5	10.0%	0	0.0%	4	2.5%	25	4.9%
男女合計	3	7.3%	2	2.9%	6	5.7%	5	3.6%	18	10.8%	6	6.2%	2	2.3%	6	2.0%	48	4.8%
5と回答																		
男性	3	14.3%	14	43.8%	10	19.6%	25	37.9%	34	38.6%	10	21.3%	10	22.7%	29	20.3%	135	27.4%
女性	11	55.0%	17	45.9%	14	25.9%	25	34.2%	27	34.2%	17	34.0%	9	20.5%	60	38.0%	180	35.0%
男女合計	14	34.1%	31	44.9%	24	22.9%	50	36.0%	61	36.5%	27	27.8%	19	21.6%	89	29.6%	315	31.3%
無回答																		
男性	0	0.0%	2	6.3%	4	7.8%	2	3.0%	8	9.1%	1	2.1%	2	4.5%	6	4.2%	25	5.1%
女性	0	0.0%	2	5.4%	2	3.7%	3	4.1%	1	1.3%	2	4.0%	2	4.5%	5	3.2%	17	3.3%
男女合計	0	0.0%	4	5.8%	6	5.7%	5	3.6%	9	5.4%	3	3.1%	4	4.5%	11	3.7%	42	4.2%
全体(人)																		
男性	21		32		51		66		88		47		44		143		492	
女性	20		37		54		73		79		50		44		158		515	
男女合計	41		69		105		139		167		97		88		301		1007	

県 南

	10	割合	20	割合	30	割合	40	割合	50	割合	64	割合	69	割合	70～	割合	全体数	割合
1と回答																		
男性	5	41.7%	2	28.6%	2	10.0%	8	38.1%	10	29.4%	7	33.3%	12	57.1%	51	64.6%	97	45.1%
女性	4	40.0%	4	36.4%	4	26.7%	13	46.4%	15	42.9%	10	38.5%	15	62.5%	60	61.9%	125	50.8%
男女合計	9	40.9%	6	33.3%	6	17.1%	21	42.9%	25	36.2%	17	36.2%	27	60.0%	111	63.1%	222	48.2%
2と回答																		
男性	1	8.3%	0	0.0%	0	0.0%	1	4.8%	4	11.8%	1	4.8%	1	4.8%	0	0.0%	8	3.7%
女性	2	20.0%	0	0.0%	1	6.7%	2	7.1%	1	2.9%	2	7.7%	1	4.2%	2	2.1%	11	4.5%
男女合計	3	13.6%	0	0.0%	1	2.9%	3	6.1%	5	7.2%	3	6.4%	2	4.4%	2	1.1%	19	4.1%
3と回答																		
男性	0	0.0%	0	0.0%	4	20.0%	3	14.3%	0	0.0%	2	9.5%	1	4.8%	5	6.3%	15	7.0%
女性	2	20.0%	0	0.0%	3	20.0%	2	7.1%	2	5.7%	3	11.5%	0	0.0%	2	2.1%	14	5.7%
男女合計	2	9.1%	0	0.0%	7	20.0%	5	10.2%	2	2.9%	5	10.6%	1	2.2%	7	4.0%	29	6.3%
4と回答																		
男性	0	0.0%	0	0.0%	1	5.0%	2	9.5%	0	0.0%	4	19.0%	0	0.0%	1	1.3%	8	3.7%
女性	0	0.0%	0	0.0%	0	0.0%	1	3.6%	2	5.7%	2	7.7%	0	0.0%	2	2.1%	7	2.8%
男女合計	0	0.0%	0	0.0%	1	2.9%	3	6.1%	2	2.9%	6	12.8%	0	0.0%	3	1.7%	15	3.3%
5と回答																		
男性	4	33.3%	3	42.9%	10	50.0%	7	33.3%	15	44.1%	7	33.3%	6	28.6%	15	19.0%	67	31.2%
女性	2	20.0%	7	63.6%	6	40.0%	9	32.1%	13	37.1%	8	30.8%	8	33.3%	28	28.9%	81	32.9%
男女合計	6	27.3%	10	55.6%	16	45.7%	16	32.7%	28	40.6%	15	31.9%	14	31.1%	43	24.4%	148	32.1%
無回答																		
男性	2	16.7%	2	28.6%	3	15.0%	0	0.0%	5	14.7%	0	0.0%	1	4.8%	7	8.9%	20	9.3%
女性	0	0.0%	0	0.0%	1	6.7%	1	3.6%	2	5.7%	1	3.8						

会 津

	10	割合	20	割合	30	割合	40	割合	50	割合	64	割合	69	割合	70～	割合	全体数	割合
1と回答																		
男性	0	0.0%	6	33.3%	10	35.7%	18	41.9%	13	40.6%	12	54.5%	20	80.0%	69	69.7%	148	54.2%
女性	3	42.9%	4	36.4%	11	44.0%	18	47.4%	22	52.4%	19	67.9%	23	71.9%	77	65.8%	177	59.0%
男女合計	3	23.1%	10	34.5%	21	39.6%	36	44.4%	35	47.3%	31	62.0%	43	75.4%	146	67.6%	325	56.7%
2と回答																		
男性	0	0.0%	1	5.6%	2	7.1%	2	4.7%	1	3.1%	0	0.0%	1	4.0%	2	2.0%	9	3.3%
女性	0	0.0%	1	9.1%	3	12.0%	0	0.0%	2	4.8%	1	3.6%	0	0.0%	3	2.6%	10	3.3%
男女合計	0	0.0%	2	6.9%	5	9.4%	2	2.5%	3	4.1%	1	2.0%	1	1.8%	5	2.3%	19	3.3%
3と回答																		
男性	0	0.0%	1	5.6%	3	10.7%	4	9.3%	3	9.4%	2	9.1%	0	0.0%	2	2.0%	15	5.5%
女性	1	14.3%	0	0.0%	4	16.0%	3	7.9%	4	9.5%	3	10.7%	1	3.1%	1	0.9%	17	5.7%
男女合計	1	7.7%	1	3.4%	7	13.2%	7	8.6%	7	9.5%	5	10.0%	1	1.8%	3	1.4%	32	5.6%
4と回答																		
男性	0	0.0%	0	0.0%	1	3.6%	2	4.7%	3	9.4%	2	9.1%	1	4.0%	1	1.0%	10	3.7%
女性	1	14.3%	1	9.1%	1	4.0%	2	5.3%	2	4.8%	0	0.0%	2	6.3%	4	3.4%	13	4.3%
男女合計	1	7.7%	1	3.4%	2	3.8%	4	4.9%	5	6.8%	2	4.0%	3	5.3%	5	2.3%	23	4.0%
5と回答																		
男性	6	100.0%	9	50.0%	10	35.7%	16	37.2%	10	31.3%	6	27.3%	3	12.0%	22	22.2%	82	30.0%
女性	2	28.6%	5	45.5%	6	24.0%	12	31.6%	11	26.2%	4	14.3%	6	18.8%	25	21.4%	71	23.7%
男女合計	8	61.5%	14	48.3%	16	30.2%	28	34.6%	21	28.4%	10	20.0%	9	15.8%	47	21.8%	153	26.7%
無回答																		
男性	0	0.0%	1	5.6%	2	7.1%	1	2.3%	2	6.3%	0	0.0%	0	0.0%	3	3.0%	9	3.3%
女性	0	0.0%	0	0.0%	0	0.0%	3	7.9%	1	2.4%	1	3.6%	0	0.0%	7	6.0%	12	4.0%
男女合計	0	0.0%	1	3.4%	2	3.8%	4	4.9%	3	4.1%	1	2.0%	0	0.0%	10	4.6%	21	3.7%
全体(人)																		
男性	6		18		28		43		32		22		25		99		273	
女性	7		11		25		38		42		28		32		117		300	
男女合計	13		29		53		81		74		50		57		216		573	

南 会 津

	10	割合	20	割合	30	割合	40	割合	50	割合	64	割合	69	割合	70～	割合	全体数	割合
1と回答																		
男性	0	0.0%	0	0.0%	1	50.0%	0	0.0%	2	66.7%	1	100.0%	2	50.0%	12	85.7%	18	60.0%
女性	0	0.0%	0	0.0%	0	0.0%	0	0.0%	1	100.0%	2	66.7%	4	100.0%	8	61.5%	15	57.7%
男女合計	0	0.0%	0	0.0%	1	25.0%	0	0.0%	3	75.0%	3	75.0%	6	75.0%	20	74.1%	33	58.9%
2と回答																		
男性	0	0.0%	0	0.0%	0	0.0%	0	0.0%	0	0.0%	0	0.0%	0	0.0%	0	0.0%	0	0.0%
女性	0	0.0%	0	0.0%	0	0.0%	1	33.3%	0	0.0%	0	0.0%	0	0.0%	0	0.0%	1	3.8%
男女合計	0	0.0%	0	0.0%	0	0.0%	1	16.7%	0	0.0%	0	0.0%	0	0.0%	0	0.0%	1	1.8%
3と回答																		
男性	0	0.0%	1	33.3%	0	0.0%	1	33.3%	0	0.0%	0	0.0%	1	25.0%	0	0.0%	3	10.0%
女性	0	0.0%	0	0.0%	0	0.0%	2	66.7%	0	0.0%	1	33.3%	0	0.0%	1	7.7%	4	15.4%
男女合計	0	0.0%	1	33.3%	0	0.0%	3	50.0%	0	0.0%	1	25.0%	1	12.5%	1	3.7%	7	12.5%
4と回答																		
男性	0	0.0%	1	33.3%	1	50.0%	1	33.3%	0	0.0%	0	0.0%	0	0.0%	0	0.0%	3	10.0%
女性	0	0.0%	0	0.0%	0	0.0%	0	0.0%	0	0.0%	0	0.0%	0	0.0%	0	0.0%	0	0.0%
男女合計	0	0.0%	1	33.3%	1	25.0%	1	16.7%	0	0.0%	0	0.0%	0	0.0%	0	0.0%	3	5.4%
5と回答																		
男性	0	0.0%	1	33.3%	0	0.0%	1	33.3%	1	33.3%	0	0.0%	1	25.0%	2	14.3%	6	20.0%
女性	0	0.0%	0	0.0%	2	100.0%	0	0.0%	0	0.0%	0	0.0%	0	0.0%	2	15.4%	4	15.4%
男女合計	0	0.0%	1	33.3%	2	50.0%	1	16.7%	1	25.0%	0	0.0%	1	12.5%	4	14.8%	10	17.9%
無回答																		
男性	0	0.0%	0	0.0%	0	0.0%	0	0.0%	0	0.0%	0	0.0%	0	0.0%	0	0.0%	0	0.0%
女性	0	0.0%	0	0.0%	0	0.0%	0	0.0%	0	0.0%	0	0.0%	0	0.0%	2	15.4%	2	7.7%
男女合計	0	0.0%	0	0.0%	0	0.0%	0	0.0%	0	0.0%	0	0.0%	0	0.0%	2	7.4%	2	3.6%
全体(人)																		
男性	0		3		2		3		3		1		4		14		30	
女性	0		0		2		3		1		3		4		13		26	
男女合計	0		3		4		6		4		4		8		27		56	

相 双

	10	割合	20	割合	30	割合	40	割合	50	割合	64	割合	69	割合	70～	割合	全体数	割合
1と回答																		
男性	4	66.7%	2	33.3%	3	25.0%	5	27.8%	6	30.0%	4	28.6%	9	45.0%	38	66.7%	71	46.4%
女性	4	66.7%	0	0.0%	6	42.9%	11	45.8%	8	40.0%	5	45.5%	14	73.7%	34	56.7%	82	51.9%
男女合計	8	66.7%	2	20.0%	9	34.6%	16	38.1%	14	35.0%	9	36.0%	23	59.0%	72	61.5%	153	49.2%
2と回答																		
男性	1	16.7%	1	16.7%	1	8.3%	2	11.1%	2	10.0%	0	0.0%	1	5.0%	5	8.8%	13	8.5%
女性	1	16.7%	0	0.0%	1	7.1%	1	4.2%	1	5.0%	0	0.0%	0	0.0%	2	3.3%	6	3.8%
男女合計	2	16.7%	1	10.0%	2	7.7%	3	7.1%	3	7.5%	0	0.0%	1	2.6%	7	6.0%	19	6.1%
3と回答																		
男性	0	0.0%	0	0.0%	0	0.0%	3	16.7%	4	20.0%	3	21.4%	1	5.0%	2	3.5%	13	8.5%
女性	0	0.0%	1	25.0%	0	0.0%	4	16.7%	3	15.0%	2	18.2%	1	5.3%	2	3.3%	13	8.2%
男女合計	0	0.0%	1	10.0%	0	0.0%	7	16.7%	7	17.5%	5	20.0%	2	5.1%	4	3.4%	26	8.4%
4と回答																		
男性	0	0.0%	0	0.0%	2	16.7%	1	5.6%	0	0.0%	0	0.0%	0	0.0%	1	1.8%	4	2.6%
女性	0	0.0%	0	0.0%	1	7.1%	1	4.2%	1	5.0%	2	18.2%	0	0.0%	1	1.7%	6	3.8%
男女合計	0	0.0%	0	0.0%	3	11.5%	2	4.8%	1	2.5%	2	8.0%	0	0.0%	2	1.7%	10	3.2%
5と回答																		
男性	1	16.7%	3	50.0%	6	50.0%	6	33.3%	7	35.0%	7	50.0%	7	35.0%	8	14.0%	45	29.4%
女性	1	16.7%	3	75.0%	6	42.9%	6	25.0%	6	30.0%	2	18.2%	3	15.8%	19	31.7%	46	29.1%
男女合計	2	16.7%	6	60.0%	12	46.2%	12	28.6%	13	32.5%	9	36.0%	10	25.6%	27	23.1%	91	29.3%
無回答																		
男性	0	0.0%	0	0.0%	0	0.0%	1	5.6%	1	5.0%	0	0.0%	2	10.0%	3	5.3%	7	4.6%
女性	0	0.0%	0	0.0%	0	0.0%	1	4.2%	1	5.0%	0	0.0%	1	5.3%	2	3.3%	5	3.2%
男女合計	0	0.0%	0	0.0%	0	0.0%	2	4.8%	2	5.0%	0	0.0						

いわき

	10	割合	20	割合	30	割合	40	割合	50	割合	64	割合	69	割合	70～	割合	全体数	割合
1と回答																		
男性	7	53.8%	0	0.0%	7	20.0%	12	40.0%	21	43.8%	18	42.9%	27	60.0%	92	71.3%	184	52.3%
女性	8	50.0%	4	23.5%	16	57.1%	10	34.5%	28	44.4%	27	58.7%	20	46.5%	95	67.4%	208	54.3%
男女合計	15	51.7%	4	14.8%	23	36.5%	22	37.3%	49	44.1%	45	51.1%	47	53.4%	187	69.3%	392	53.3%
2と回答																		
男性	2	15.4%	2	20.0%	3	8.6%	2	6.7%	1	2.1%	2	4.8%	3	6.7%	1	0.8%	16	4.5%
女性	1	6.3%	0	0.0%	0	0.0%	4	13.8%	6	9.5%	2	4.3%	1	2.3%	3	2.1%	17	4.4%
男女合計	3	10.3%	2	7.4%	3	4.8%	6	10.2%	7	6.3%	4	4.5%	4	4.5%	4	1.5%	33	4.5%
3と回答																		
男性	0	0.0%	3	30.0%	3	8.6%	3	10.0%	6	12.5%	2	4.8%	3	6.7%	1	0.8%	21	6.0%
女性	0	0.0%	2	11.8%	5	17.9%	3	10.3%	3	4.8%	3	6.5%	4	9.3%	2	1.4%	22	5.7%
男女合計	0	0.0%	5	18.5%	8	12.7%	6	10.2%	9	8.1%	5	5.7%	7	8.0%	3	1.1%	43	5.9%
4と回答																		
男性	2	15.4%	2	20.0%	3	8.6%	4	13.3%	4	8.3%	4	9.5%	0	0.0%	2	1.6%	21	6.0%
女性	0	0.0%	0	0.0%	2	7.1%	3	10.3%	1	1.6%	3	6.5%	0	0.0%	2	1.4%	11	2.9%
男女合計	2	6.9%	2	7.4%	5	7.9%	7	11.9%	5	4.5%	7	8.0%	0	0.0%	4	1.5%	32	4.4%
5と回答																		
男性	1	7.7%	1	10.0%	17	48.6%	8	26.7%	13	27.1%	14	33.3%	11	24.4%	30	23.3%	95	27.0%
女性	7	43.8%	10	58.8%	4	14.3%	9	31.0%	23	36.5%	10	21.7%	16	37.2%	35	24.8%	114	29.8%
男女合計	8	27.6%	11	40.7%	21	33.3%	17	28.8%	36	32.4%	24	27.3%	27	30.7%	65	24.1%	209	28.4%
無回答																		
男性	1	7.7%	2	20.0%	2	5.7%	1	3.3%	3	6.3%	2	4.8%	1	2.2%	3	2.3%	15	4.3%
女性	0	0.0%	1	5.9%	1	3.6%	0	0.0%	2	3.2%	1	2.2%	2	4.7%	4	2.8%	11	2.9%
男女合計	1	3.4%	3	11.1%	3	4.8%	1	1.7%	5	4.5%	3	3.4%	3	3.4%	7	2.6%	26	3.5%
全体(人)																		
男性	13		10		35		30		48		42		45		129		352	
女性	16		17		28		29		63		46		43		141		383	
男女合計	29		27		63		59		111		88		88		270		735	

全県 (60歳以上・再掲)

	64	割合	69	割合	70	割合	80	割合	90	割合	全体数	割合
1と回答												
男性	93	47.4%	129	61.1%	277	64.1%	142	75.9%	24	55.8%	665	62.2%
女性	106	51.0%	137	62.0%	267	62.8%	157	56.7%	39	53.4%	706	58.6%
男女合計	199	49.3%	266	61.6%	544	63.5%	299	64.4%	63	54.3%	1371	60.3%
2と回答												
男性	8	4.1%	9	4.3%	13	3.0%	4	2.1%	1	2.3%	35	3.3%
女性	9	4.3%	7	3.2%	8	1.9%	5	1.8%	1	1.4%	30	2.5%
男女合計	17	4.2%	16	3.7%	21	2.5%	9	1.9%	2	1.7%	65	2.9%
3と回答												
男性	15	7.7%	11	5.2%	18	4.2%	4	2.1%	2	4.7%	50	4.7%
女性	16	7.7%	8	3.6%	12	2.8%	7	2.5%	5	6.8%	48	4.0%
男女合計	31	7.7%	19	4.4%	30	3.5%	11	2.4%	7	6.0%	98	4.3%
4と回答												
男性	17	8.7%	5	2.4%	7	1.6%	1	0.5%	0	0.0%	30	2.8%
女性	12	5.8%	3	1.4%	11	2.6%	3	1.1%	1	1.4%	30	2.5%
男女合計	29	7.2%	8	1.9%	18	2.1%	4	0.9%	1	0.9%	60	2.6%
5と回答												
男性	60	30.6%	50	23.7%	102	23.6%	31	16.6%	13	30.2%	256	23.9%
女性	58	27.9%	57	25.8%	119	28.0%	88	31.8%	24	32.9%	346	28.7%
男女合計	118	29.2%	107	24.8%	221	25.8%	119	25.6%	37	31.9%	602	26.5%
無回答												
男性	3	1.5%	7	3.3%	15	3.5%	5	2.7%	3	7.0%	33	3.1%
女性	7	3.4%	9	4.1%	8	1.9%	17	6.1%	3	4.1%	44	3.7%
男女合計	10	2.5%	16	3.7%	23	2.7%	22	4.7%	6	5.2%	77	3.4%
全体(人)												
男性	196		211		432		187		43		1069	
女性	208		221		425		277		73		1204	
男女合計	404		432		857		464		116		2273	

5 食生活（朝食・夕食）の状況（調査票 問5）

問5 あなたは、夕食を家族とどのくらい一緒に食べていますか。（あてはまる番号1つに○）

- 1 ほとんど毎日 2 週に4～5日 3 週に2～3日
4 週に1日程度 5 ほとんどない

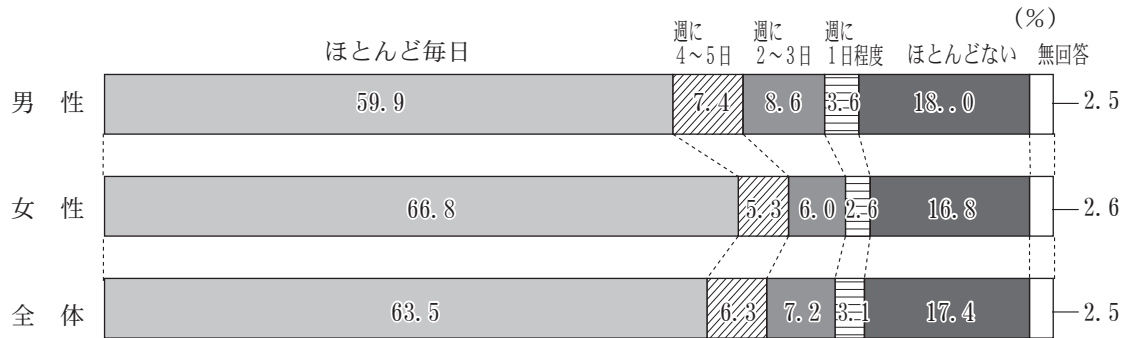

	10	割合	20	割合	30	割合	40	割合	50	割合	64	割合	69	割合	70	割合	80	割合	90	割合	全体数	割合
1と回答																						
男性	46	56.1%	55	44.7%	99	51.6%	106	44.5%	157	50.3%	114	58.2%	149	70.6%	313	72.5%	144	77.0%	25	58.1%	1208	59.9%
女性	49	66.2%	69	55.2%	130	71.0%	179	67.8%	220	63.6%	147	70.7%	157	71.0%	306	72.0%	161	58.1%	50	68.5%	1468	66.8%
男女合計	95	60.9%	124	50.0%	229	61.1%	285	56.8%	377	57.3%	261	64.6%	306	70.8%	619	72.2%	305	65.7%	75	64.7%	2676	63.5%
2と回答																						
男性	8	9.8%	19	15.4%	18	9.4%	32	13.4%	21	6.7%	15	7.7%	16	7.6%	17	3.9%	2	1.1%	1	2.3%	149	7.4%
女性	6	8.1%	9	7.2%	11	6.0%	20	7.6%	30	8.7%	12	5.8%	11	5.0%	9	2.1%	7	2.5%	2	2.7%	117	5.3%
男女合計	14	9.0%	28	11.3%	29	7.7%	52	10.4%	51	7.8%	27	6.7%	27	6.3%	26	3.0%	9	1.9%	3	2.6%	266	6.3%
3と回答																						
男性	6	7.3%	12	9.8%	28	14.6%	46	19.3%	37	11.9%	14	7.1%	9	4.3%	16	3.7%	4	2.1%	1	2.3%	173	8.6%
女性	5	6.8%	14	11.2%	18	9.8%	23	8.7%	27	7.8%	12	5.8%	8	3.6%	11	2.6%	11	4.0%	2	2.7%	131	6.0%
男女合計	11	7.1%	26	10.5%	46	12.3%	69	13.7%	64	9.7%	26	6.4%	17	3.9%	27	3.2%	15	3.2%	3	2.6%	304	7.2%
4と回答																						
男性	1	1.2%	3	2.4%	9	4.7%	13	5.5%	20	6.4%	12	6.1%	5	2.4%	6	1.4%	4	2.1%	0	0.0%	73	3.6%
女性	0	0.0%	4	3.2%	10	5.5%	5	1.9%	9	2.6%	9	4.3%	5	2.3%	8	1.9%	5	1.8%	1	1.4%	56	2.6%
男女合計	1	0.6%	7	2.8%	19	5.1%	18	3.6%	29	4.4%	21	5.2%	10	2.3%	14	1.6%	9	1.9%	1	0.9%	129	3.1%
5と回答																						
男性	17	20.7%	31	25.2%	37	19.3%	41	17.2%	69	22.1%	37	18.9%	29	13.7%	66	15.3%	24	12.8%	12	27.9%	363	18.0%
女性	11	14.9%	27	21.6%	13	7.1%	34	12.9%	54	15.6%	28	13.5%	32	14.5%	82	19.3%	72	26.0%	15	20.5%	368	16.8%
男女合計	28	17.9%	58	23.4%	50	13.3%	75	14.9%	123	18.7%	65	16.1%	61	14.1%	148	17.3%	96	20.7%	27	23.3%	731	17.4%
無回答																						
男性	4	4.9%	3	2.4%	1	0.5%	0	0.0%	8	2.6%	4	2.0%	3	1.4%	14	3.2%	9	4.8%	4	9.3%	50	2.5%
女性	3	4.1%	2	1.6%	1	0.5%	3	1.1%	6	1.7%	0	0.0%	8	3.6%	9	2.1%	21	7.6%	3	4.1%	56	2.6%
男女合計	7	4.5%	5	2.0%	2	0.5%	3	0.6%	14	2.1%	4	1.0%	11	2.5%	23	2.7%	30	6.5%	7	6.0%	106	2.5%
全体(人)																						
男性	82	123	192	238	312	196	211	432	187	43	2016											
女性	74	125	183	264	346	208	221	425	277	73	2196											
男女合計	156	248	375	502	658	404	432	857	464	116	4212											

県 北

	10	割合	20	割合	30	割合	40	割合	50	割合	64	割合	69	割合	70～	割合	全体数	割合
1と回答																		
男性	12	50.0%	23	48.9%	25	56.8%	23	40.4%	43	49.4%	28	57.1%	35	67.3%	100	70.9%	289	57.7%
女性	7	46.7%	23	51.1%	31	68.9%	45	65.2%	64	60.4%	31	70.5%	36	65.5%	123	65.1%	360	63.4%
男女合計	19	48.7%	46	50.0%	56	62.9%	68	54.0%	107	55.4%	59	63.4%	71	66.4%	223	67.6%	649	60.7%
2と回答																		
男性	2	8.3%	5	10.6%	1	2.3%	7	12.3%	7	8.0%	3	6.1%	3	5.8%	3	2.1%	31	6.2%
女性	2	13.3%	5	11.1%	2	4.4%	7	10.1%	10	9.4%	2	4.5%	5	9.1%	4	2.1%	37	6.5%
男女合計	4	10.3%	10	10.9%	3	3.4%	14	11.1%	17	8.8%	5	5.4%	8	7.5%	7	2.1%	68	6.4%
3と回答																		
男性	1	4.2%	4	8.5%	5	11.4%	12	21.1%	10	11.5%	5	10.2%	7	13.5%	6	4.3%	50	10.0%
女性	0	0.0%	6	13.3%	5	11.1%	5	7.2%	9	8.5%	3	6.8%	2	3.6%	5	2.6%	35	6.2%
男女合計	1	2.6%	10	10.9%	10	11.2%	17	13.5%	19	9.8%	8	8.6%	9	8.4%	11	3.3%	85	8.0%
4と回答																		
男性	1	4.2%	0	0.0%	2	4.5%	2	3.5%	5	5.7%	2	4.1%	1	1.9%	2	1.4%	15	3.0%
女性	0	0.0%	1	2.2%	4	8.9%	1	1.4%	2	1.9%	3	6.8%	2	3.6%	3	1.6%	16	2.8%
男女合計	1	2.6%	1	1.1%	6	6.7%	3	2.4%	7	3.6%	5	5.4%	3	2.8%	5	1.5%	31	2.9%
5と回答																		
男性	7	29.2%	14	29.8%	11	25.0%	13	22.8%	20	23.0%	9	18.4%	5	9.6%	28	19.9%	107	21.4%
女性	5	33.3%	8	17.8%	3	6.7%	11	15.9%	19	17.9%	5	11.4%	9	16.4%	44	23.3%	104	18.3%
男女合計	12	30.8%	22	23.9%	14	15.7%	24	19.0%	39	20.2%	14	15.1%	14	13.1%	72	21.8%	211	19.7%
無回答																		
男性	1	4.2%	1	2.1%	0	0.0%	0	0.0%	2	2.3%	2	4.1%	1	1.9%	2	1.4%	9	1.8%
女性	1	6.7%	2	4.4%	0	0.0%	0	0.0%	2	1.9%	0	0.0%	1	1.8%	10	5.3%	16	2.8%
男女合計	2	5.1%	3	3.3%	0	0.0%	0	0.0%	4	2.1%	2	2.2%	2	1.9%	12	3.6%	25	2.3%
全体(人)																		
男性	24		47		44		57		87		49		52		141		501	
女性	15		45		45		69		106		44		55		189		568	
男女合計	39		92		89		126		193		93		107		330		1069	

県 中

	10	割合	20	割合	30	割合	40	割合	50	割合	64	割合	69	割合	70～	割合	全体数	割合
1と回答																		
男性	16	76.2%	16	50.0%	36	70.6%	28	42.4%	37	42.0%	39	83.0%	30	68.2%	104	72.7%	306	62.2%
女性	12	60.0%	22	59.5%	44	81.5%	49	67.1%	49	62.0%	34	68.0%	34	77.3%	99	62.7%	343	66.6%
男女合計	28	68.3%	38	55.1%	80	76.2%	77	55.4%	86	51.5%	73	75.3%	64	72.7%	203	67.4%	649	64.4%
2と回答																		
男性	3	14.3%	8	25.0%	5	9.8%	11	16.7%	7	8.0%	2	4.3%	3	6.8%	4	2.8%	43	8.7%
女性	1	5.0%	2	5.4%	2	3.7%	3	4.1%	14	17.7%	1	2.0%	2	4.5%	0	0.0%	25	4.9%
男女合計	4	9.8%	10	14.5%	7	6.7%	14	10.1%	21	12.6%	3	3.1%	5	5.7%	4	1.3%	68	6.8%
3と回答																		
男性	2	9.5%	4	12.5%	2	3.9%	13	19.7%	12	13.6%	2	4.3%	1	2.3%	7	4.9%	43	8.7%
女性	1	5.0%	6	16.2%	1	1.9%	11	15.1%	5	6.3%	3	6.0%	1	2.3%	7	4.4%	35	6.8%
男女合計	3	7.3%	10	14.5%	3	2.9%	24	17.3%	17	10.2%	5	5.2%	2	2.3%	14	4.7%	78	7.7%
4と回答																		
男性	0	0.0%	1	3.1%	2	3.9%	4	6.1%	6	6.8%	1	2.1%	2	4.5%	4	2.8%	20	4.1%
女性	0	0.0%	0	0.0%	3	5.6%	0	0.0%	4	5.1%	3	6.0%	0	0.0%	1	0.6%	11	2.1%
男女合計	0	0.0%	1	1.4%	5	4.8%	4	2.9%	10	6.0%	4	4.1%	2	2.3%	5	1.7%	31	3.1%
5と回答																		
男性	0	0.0%	3	9.4%	5	9.8%	10	15.2%	22	25.0%	3	6.4%	8	18.2%	17	11.9%	68	13.8%
女性	5	25.0%	7	18.9%	4	7.4%	9	12.3%	6	7.6%	9	18.0%	5	11.4%	43	27.2%	88	17.1%
男女合計	5	12.2%	10	14.5%	9	8.6%	19	13.7%	28	16.8%	12	12.4%	13	14.8%	60	19.9%	156	15.5%
無回答																		
男性	0	0.0%	0	0.0%	1	2.0%	0	0.0%	4	4.5%	0	0.0%	0	0.0%	7	4.9%	12	2.4%
女性	1	5.0%	0	0.0%	0	0.0%	1	1.4%	1	1.3%	0	0.0%	2	4.5%	8	5.1%	13	2.5%
男女合計	1	2.4%	0	0.0%	1	1.0%	1	0.7%	5	3.0%	0	0.0%	2	2.3%	15	5.0%	25	2.5%
全体(人)																		
男性	21		32		51		66		88		47		44		143		492	
女性	20		37		54		73		79		50		44		158		515	
男女合計	41		69		105		139		167		97		88		301		1007	

県 南

	10	割合	20	割合	30	割合	40	割合	50	割合	64	割合	69	割合	70～	割合	全体数	割合
1と回答																		
男性	8	66.7%	1	14.3%	8	40.0%	4	19.0%	22	64.7%	7	33.3%	13	61.9%	53	67.1%	116	54.0%
女性	5	50.0%	5	45.5%	9	60.0%	17	60.7%	23	65.7%	17	65.4%	13	54.2%	64	66.0%	153	62.2%
男女合計	13	59.1%	6	33.3%	17	48.6%	21	42.9%	45	65.2%	24	51.1%	26	57.8%	117	66.5%	269	58.4%
2と回答																		
男性	1	8.3%	0	0.0%	2	10.0%	5	23.8%	0	0.0%	1	4.8%	2	9.5%	0	0.0%	11	5.1%
女性	2	20.0%	0	0.0%	1	6.7%	2	7.1%	2	5.7%	1	3.8%	2	8.3%	1	1.0%	11	4.5%
男女合計	3	13.6%	0	0.0%	3	8.6%	7	14.3%	2	2.9%	2	4.3%	4	8.9%	1	0.6%	22	4.8%
3と回答																		
男性	0	0.0%	1	14.3%	4	20.0%	7	33.3%	3	8.8%	3	14.3%	0	0.0%	4	5.1%	22	10.2%
女性	2	20.0%	1	9.1%	2	13.3%	3	10.7%	2	5.7%	3	11.5%	3	12.5%	2	2.1%	18	7.3%
男女合計	2	9.1%	2	11.1%	6	17.1%	10	20.4%	5	7.2%	6	12.8%	3	6.7%	6	3.4%	40	8.7%
4と回答																		
男性	0	0.0%	0	0.0%	2	10.0%	2	9.5%	2	5.9%	3	14.3%	1	4.8%	3	3.8%	13	6.0%
女性	0	0.0%	1	9.1%	2	13.3%	1	3.6%	2	5.7%	0	0.0%	0	0.0%	4	4.1%	10	4.1%
男女合計	0	0.0%	1	5.6%	4	11.4%	3	6.1%	4	5.8%	3	6.4%	1	2.2%	7	4.0%	23	5.0%
5と回答																		
男性	1	8.3%	4	57.1%	4	20.0%	3	14.3%	6	17.6%	6	28.6%	4	19.0%	12	15.2%	40	18.6%
女性	0	0.0%	4	36.4%	1	6.7%	5	17.9%	3	8.6%	5	19.2%	4	16.7%	23	23.7%	45	18.3%
男女合計	1	4.5%	8	44.4%	5	14.3%	8	16.3%	9	13.0%	11	23.4%	8	17.8%	35	19.9%	85	18.4%
無回答																		
男性	2	16.7%	1	14.3%	0	0.0%	0	0.0%	1	2.9%	1	4.8%	1	4.8%	7	8.9%	13	6.0%
女性	1	10.0%	0	0.0%	0	0.0%	0	0.0%	3	8.6%	0	0.0						

会 津

	10	割合	20	割合	30	割合	40	割合	50	割合	64	割合	69	割合	70～	割合	全体数	割合
1と回答																		
男性	0	0.0%	9	50.0%	13	46.4%	24	55.8%	16	50.0%	13	59.1%	21	84.0%	75	75.8%	171	62.6%
女性	6	85.7%	4	36.4%	17	68.0%	25	65.8%	29	69.0%	23	82.1%	24	75.0%	82	70.1%	210	70.0%
男女合計	6	46.2%	13	44.8%	30	56.6%	49	60.5%	45	60.8%	36	72.0%	45	78.9%	157	72.7%	381	66.5%
2と回答																		
男性	0	0.0%	1	5.6%	2	7.1%	4	9.3%	2	6.3%	2	9.1%	1	4.0%	5	5.1%	17	6.2%
女性	0	0.0%	2	18.2%	3	12.0%	3	7.9%	1	2.4%	1	3.6%	0	0.0%	4	3.4%	14	4.7%
男女合計	0	0.0%	3	10.3%	5	9.4%	7	8.6%	3	4.1%	3	6.0%	1	1.8%	9	4.2%	31	5.4%
3と回答																		
男性	1	16.7%	0	0.0%	7	25.0%	6	14.0%	4	12.5%	0	0.0%	0	0.0%	0	0.0%	18	6.6%
女性	1	14.3%	0	0.0%	3	12.0%	4	10.5%	5	11.9%	1	3.6%	0	0.0%	3	2.6%	17	5.7%
男女合計	2	15.4%	0	0.0%	10	18.9%	10	12.3%	9	12.2%	1	2.0%	0	0.0%	3	1.4%	35	6.1%
4と回答																		
男性	0	0.0%	1	5.6%	1	3.6%	3	7.0%	4	12.5%	1	4.5%	0	0.0%	1	1.0%	11	4.0%
女性	0	0.0%	2	18.2%	1	4.0%	2	5.3%	0	0.0%	0	0.0%	2	6.3%	4	3.4%	11	3.7%
男女合計	0	0.0%	3	10.3%	2	3.8%	5	6.2%	4	5.4%	1	2.0%	2	3.5%	5	2.3%	22	3.8%
5と回答																		
男性	5	83.3%	6	33.3%	5	17.9%	6	14.0%	5	15.6%	6	27.3%	2	8.0%	15	15.2%	50	18.3%
女性	0	0.0%	3	27.3%	1	4.0%	3	7.9%	7	16.7%	3	10.7%	5	15.6%	16	13.7%	38	12.7%
男女合計	5	38.5%	9	31.0%	6	11.3%	9	11.1%	12	16.2%	9	18.0%	7	12.3%	31	14.4%	88	15.4%
無回答																		
男性	0	0.0%	1	5.6%	0	0.0%	0	0.0%	1	3.1%	0	0.0%	1	4.0%	3	3.0%	6	2.2%
女性	0	0.0%	0	0.0%	0	0.0%	1	2.6%	0	0.0%	0	0.0%	1	3.1%	8	6.8%	10	3.3%
男女合計	0	0.0%	1	3.4%	0	0.0%	1	1.2%	1	1.4%	0	0.0%	2	3.5%	11	5.1%	16	2.8%
全体(人)																		
男性	6		18		28		43		32		22		25		99		273	
女性	7		11		25		38		42		28		32		117		300	
男女合計	13		29		53		81		74		50		57		216		573	

南 会 津

	10	割合	20	割合	30	割合	40	割合	50	割合	64	割合	69	割合	70～	割合	全体数	割合
1と回答																		
男性	0	0.0%	0	0.0%	2	100.0%	3	100.0%	2	66.7%	1	100.0%	2	50.0%	12	85.7%	22	73.3%
女性	0	0.0%	0	0.0%	1	50.0%	3	100.0%	1	100.0%	3	100.0%	4	100.0%	10	76.9%	22	84.6%
男女合計	0	0.0%	0	0.0%	3	75.0%	6	100.0%	3	75.0%	4	100.0%	6	75.0%	22	81.5%	44	78.6%
2と回答																		
男性	0	0.0%	0	0.0%	0	0.0%	0	0.0%	0	0.0%	0	0.0%	0	0.0%	0	0.0%	0	0.0%
女性	0	0.0%	0	0.0%	0	0.0%	0	0.0%	0	0.0%	0	0.0%	0	0.0%	0	0.0%	0	0.0%
男女合計	0	0.0%	0	0.0%	0	0.0%	0	0.0%	0	0.0%	0	0.0%	0	0.0%	0	0.0%	0	0.0%
3と回答																		
男性	0	0.0%	1	33.3%	0	0.0%	0	0.0%	0	0.0%	0	0.0%	0	0.0%	0	0.0%	1	3.3%
女性	0	0.0%	0	0.0%	0	0.0%	0	0.0%	0	0.0%	0	0.0%	0	0.0%	1	7.7%	1	3.8%
男女合計	0	0.0%	1	33.3%	0	0.0%	0	0.0%	0	0.0%	0	0.0%	0	0.0%	1	3.7%	2	3.6%
4と回答																		
男性	0	0.0%	1	33.3%	0	0.0%	0	0.0%	0	0.0%	0	0.0%	1	25.0%	0	0.0%	2	6.7%
女性	0	0.0%	0	0.0%	0	0.0%	0	0.0%	0	0.0%	0	0.0%	0	0.0%	0	0.0%	0	0.0%
男女合計	0	0.0%	1	33.3%	0	0.0%	0	0.0%	0	0.0%	0	0.0%	1	12.5%	0	0.0%	2	3.6%
5と回答																		
男性	0	0.0%	1	33.3%	0	0.0%	0	0.0%	1	33.3%	0	0.0%	1	25.0%	2	14.3%	5	16.7%
女性	0	0.0%	0	0.0%	1	50.0%	0	0.0%	0	0.0%	0	0.0%	0	0.0%	2	15.4%	3	11.5%
男女合計	0	0.0%	1	33.3%	1	25.0%	0	0.0%	1	25.0%	0	0.0%	1	12.5%	4	14.8%	8	14.3%
無回答																		
男性	0	0.0%	0	0.0%	0	0.0%	0	0.0%	0	0.0%	0	0.0%	0	0.0%	0	0.0%	0	0.0%
女性	0	0.0%	0	0.0%	0	0.0%	0	0.0%	0	0.0%	0	0.0%	0	0.0%	0	0.0%	0	0.0%
男女合計	0	0.0%	0	0.0%	0	0.0%	0	0.0%	0	0.0%	0	0.0%	0	0.0%	0	0.0%	0	0.0%
全体(人)																		
男性	0		3		2		3		3		1		4		14		30	
女性	0		0		2		3		1		3		4		13		26	
男女合計	0		3		4		6		4		4		8		27		56	

相 双

	10	割合	20	割合	30	割合	40	割合	50	割合	64	割合	69	割合	70～	割合	全体数	割合
1と回答																		
男性	3	50.0%	3	50.0%	5	41.7%	9	50.0%	8	40.0%	5	35.7%	12	60.0%	40	70.2%	85	55.6%
女性	5	83.3%	3	75.0%	9	64.3%	18	75.0%	14	70.0%	7	63.6%	15	78.9%	38	63.3%	109	69.0%
男女合計	8	66.7%	6	60.0%	14	53.8%	27	64.3%	22	55.0%	12	48.0%	27	69.2%	78	66.7%	194	62.4%
2と回答																		
男性	1	16.7%	2	33.3%	0	0.0%	0	0.0%	3	15.0%	1	7.1%	2	10.0%	6	10.5%	15	9.8%
女性	1	16.7%	0	0.0%	1	7.1%	2	8.3%	1	5.0%	1	9.1%	0	0.0%	6	10.0%	12	7.6%
男女合計	2	16.7%	2	20.0%	1	3.8%	2	4.8%	4	10.0%	2	8.0%	2	5.1%	12	10.3%	27	8.7%
3と回答																		
男性	1	16.7%	0	0.0%	4	33.3%	4	22.2%	3	15.0%	2	14.3%	0	0.0%	1	1.8%	15	9.8%
女性	0	0.0%	1	25.0%	4	28.6%	0	0.0%	3	15.0%	1	9.1%	1	5.3%	2	3.3%	12	7.6%
男女合計	1	8.3%	1	10.0%	8	30.8%	4	9.5%	6	15.0%	3	12.0%	1	2.6%	3	2.6%	27	8.7%
4と回答																		
男性	0	0.0%	0	0.0%	0	0.0%	0	0.0%	1	5.0%	1	7.1%	0	0.0%	0	0.0%	2	1.3%
女性	0	0.0%	0	0.0%	0	0.0%	1	4.2%	0	0.0%	1	9.1%	0	0.0%	1	1.7%	3	1.9%
男女合計	0	0.0%	0	0.0%	0	0.0%	1	2.4%	1	2.5%	2	8.0%	0	0.0%	1	0.9%	5	1.6%
5と回答																		
男性	0	0.0%	1	16.7%	3	25.0%	5	27.8%	5	25.0%	5	35.7%	6	30.0%	6	10.5%	31	20.3%
女性	0	0.0%	0	0.0%	0	0.0%	3	12.5%	2	10.0%	1	9.1%	2	10.5%	11	18.3%	19	12.0%
男女合計	0	0.0%	1	10.0%	3	11.5%	8	19.0%	7	17.5%	6	24.0%	8	20.5%	17	14.5%	50	16.1%
無回答																		
男性	1	16.7%	0	0.0%	0	0.0%	0	0.0%	0	0.0%	0	0.0%	0	0.0%	4	7.0%	5	3.3%
女性	0	0.0%	0	0.0%	0	0.0%	0	0.0%	0	0.0%	0	0.0%	1	5.3%	2	3.3%	3	1.9%
男女合計	1	8.3%	0	0.0%	0	0.0%	0	0.0%	0	0.0%	0	0.0%	1					

いわき

	10	割合	20	割合	30	割合	40	割合	50	割合	64	割合	69	割合	70～	割合	全体数	割合
1と回答																		
男性	7	53.8%	3	30.0%	10	28.6%	15	50.0%	29	60.4%	21	50.0%	36	80.0%	98	76.0%	219	62.2%
女性	14	87.5%	12	70.6%	19	67.9%	22	75.9%	40	63.5%	32	69.6%	31	72.1%	101	71.6%	271	70.8%
男女合計	21	72.4%	15	55.6%	29	46.0%	37	62.7%	69	62.2%	53	60.2%	67	76.1%	199	73.7%	490	66.7%
2と回答																		
男性	1	7.7%	3	30.0%	8	22.9%	5	16.7%	2	4.2%	6	14.3%	5	11.1%	2	1.6%	32	9.1%
女性	0	0.0%	0	0.0%	2	7.1%	3	10.3%	2	3.2%	6	13.0%	2	4.7%	3	2.1%	18	4.7%
男女合計	1	3.4%	3	11.1%	10	15.9%	8	13.6%	4	3.6%	12	13.6%	7	8.0%	5	1.9%	50	6.8%
3と回答																		
男性	1	7.7%	2	20.0%	6	17.1%	4	13.3%	5	10.4%	2	4.8%	1	2.2%	3	2.3%	24	6.8%
女性	1	6.3%	0	0.0%	3	10.7%	0	0.0%	3	4.8%	1	2.2%	1	2.3%	4	2.8%	13	3.4%
男女合計	2	6.9%	2	7.4%	9	14.3%	4	6.8%	8	7.2%	3	3.4%	2	2.3%	7	2.6%	37	5.0%
4と回答																		
男性	0	0.0%	0	0.0%	2	5.7%	2	6.7%	2	4.2%	4	9.5%	0	0.0%	0	0.0%	10	2.8%
女性	0	0.0%	0	0.0%	0	0.0%	0	0.0%	1	1.6%	2	4.3%	1	2.3%	1	0.7%	5	1.3%
男女合計	0	0.0%	0	0.0%	2	3.2%	2	3.4%	3	2.7%	6	6.8%	1	1.1%	1	0.4%	15	2.0%
5と回答																		
男性	4	30.8%	2	20.0%	9	25.7%	4	13.3%	10	20.8%	8	19.0%	3	6.7%	22	17.1%	62	17.6%
女性	1	6.3%	5	29.4%	3	10.7%	3	10.3%	17	27.0%	5	10.9%	7	16.3%	30	21.3%	71	18.5%
男女合計	5	17.2%	7	25.9%	12	19.0%	7	11.9%	27	24.3%	13	14.8%	10	11.4%	52	19.3%	133	18.1%
無回答																		
男性	0	0.0%	0	0.0%	0	0.0%	0	0.0%	0	0.0%	1	2.4%	0	0.0%	4	3.1%	5	1.4%
女性	0	0.0%	0	0.0%	1	3.6%	1	3.4%	0	0.0%	0	0.0%	1	2.3%	2	1.4%	5	1.3%
男女合計	0	0.0%	0	0.0%	1	1.6%	1	1.7%	0	0.0%	1	1.1%	1	1.1%	6	2.2%	10	1.4%
全体(人)																		
男性	13		10		35		30		48		42		45		129		352	
女性	16		17		28		29		63		46		43		141		383	
男女合計	29		27		63		59		111		88		88		270		735	

全県 (60歳以上・再掲)

	64	割合	69	割合	70	割合	80	割合	90	割合	全体数	割合
1と回答												
男性	114	58.2%	149	70.6%	313	72.5%	144	77.0%	25	58.1%	745	69.7%
女性	147	70.7%	157	71.0%	306	72.0%	161	58.1%	50	68.5%	821	68.2%
男女合計	261	64.6%	306	70.8%	619	72.2%	305	65.7%	75	64.7%	1566	68.9%
2と回答												
男性	15	7.7%	16	7.6%	17	3.9%	2	1.1%	1	2.3%	51	4.8%
女性	12	5.8%	11	5.0%	9	2.1%	7	2.5%	2	2.7%	41	3.4%
男女合計	27	6.7%	27	6.3%	26	3.0%	9	1.9%	3	2.6%	92	4.0%
3と回答												
男性	14	7.1%	9	4.3%	16	3.7%	4	2.1%	1	2.3%	44	4.1%
女性	12	5.8%	8	3.6%	11	2.6%	11	4.0%	2	2.7%	44	3.7%
男女合計	26	6.4%	17	3.9%	27	3.2%	15	3.2%	3	2.6%	88	3.9%
4と回答												
男性	12	6.1%	5	2.4%	6	1.4%	4	2.1%	0	0.0%	27	2.5%
女性	9	4.3%	5	2.3%	8	1.9%	5	1.8%	1	1.4%	28	2.3%
男女合計	21	5.2%	10	2.3%	14	1.6%	9	1.9%	1	0.9%	55	2.4%
5と回答												
男性	37	18.9%	29	13.7%	66	15.3%	24	12.8%	12	27.9%	168	15.7%
女性	28	13.5%	32	14.5%	82	19.3%	72	26.0%	15	20.5%	229	19.0%
男女合計	65	16.1%	61	14.1%	148	17.3%	96	20.7%	27	23.3%	397	17.5%
無回答												
男性	4	2.0%	3	1.4%	14	3.2%	9	4.8%	4	9.3%	34	3.2%
女性	0	0.0%	8	3.6%	9	2.1%	21	7.6%	3	4.1%	41	3.4%
男女合計	4	1.0%	11	2.5%	23	2.7%	30	6.5%	7	6.0%	75	3.3%
全体(人)												
男性	196		211		432		187		43		1069	
女性	208		221		425		277		73		1204	
男女合計	404		432		857		464		116		2273	

6 「食育推進月間」「食育の日」の認知度（調査票 問6）

問6 あなたは、食育推進月間（6月）と食育の日（毎月19日）を知っていますか。（あてはまる番号1つに○）

- 1 知っている 2 名称は知っているが、月日までは知らない
3 知らない

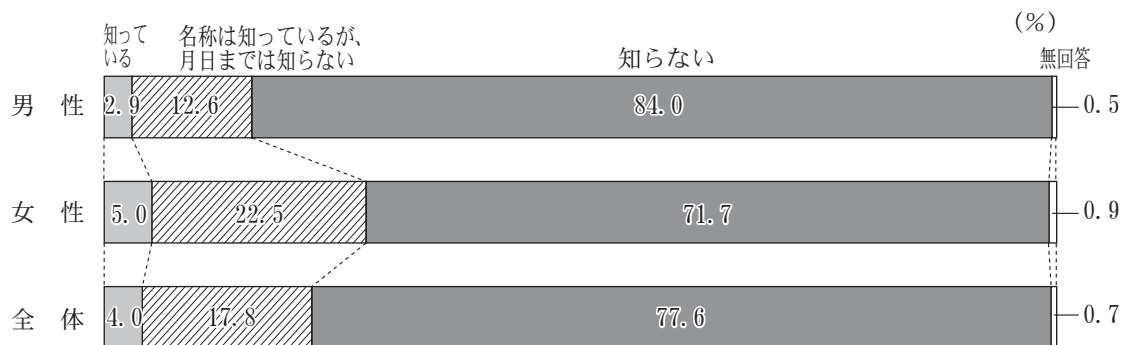

	10	割合	20	割合	30	割合	40	割合	50	割合	64	割合	69	割合	70	割合	80	割合	90	割合	全体数	割合
1と回答																						
男性	4	4.9%	6	4.9%	2	1.0%	8	3.4%	14	4.5%	8	4.1%	6	2.8%	6	1.4%	5	2.7%	0	0.0%	59	2.9%
女性	1	1.4%	8	6.4%	13	7.1%	11	4.2%	26	7.5%	4	1.9%	12	5.4%	25	5.9%	8	2.9%	1	1.4%	109	5.0%
男女合計	5	3.2%	14	5.6%	15	4.0%	19	3.8%	40	6.1%	12	3.0%	18	4.2%	31	3.6%	13	2.8%	1	0.9%	168	4.0%
2と回答																						
男性	6	7.3%	9	7.3%	22	11.5%	19	8.0%	38	12.2%	19	9.7%	27	12.8%	70	16.2%	35	18.7%	9	20.9%	254	12.6%
女性	14	18.9%	29	23.2%	30	16.4%	56	21.2%	75	21.7%	50	24.0%	54	24.4%	111	26.1%	67	24.2%	8	11.0%	494	22.5%
男女合計	20	12.8%	38	15.3%	52	13.9%	75	14.9%	113	17.2%	69	17.1%	81	18.8%	181	21.1%	102	22.0%	17	14.7%	748	17.8%
3と回答																						
男性	72	87.8%	107	87.0%	168	87.5%	211	88.7%	258	82.7%	169	86.2%	177	83.9%	353	81.7%	146	78.1%	32	74.4%	1693	84.0%
女性	59	79.7%	87	69.6%	140	76.5%	197	74.6%	245	70.8%	153	73.6%	154	69.7%	281	66.1%	194	70.0%	64	87.7%	1574	71.7%
男女合計	131	84.0%	194	78.2%	308	82.1%	408	81.3%	503	76.4%	322	79.7%	331	76.6%	634	74.0%	340	73.3%	96	82.8%	3267	77.6%
無回答																						
男性	0	0.0%	1	0.8%	0	0.0%	0	0.0%	2	0.6%	0	0.0%	1	0.5%	3	0.7%	1	0.5%	2	4.7%	10	0.5%
女性	0	0.0%	1	0.8%	0	0.0%	0	0.0%	0	0.0%	1	0.5%	1	0.5%	8	1.9%	8	2.9%	0	0.0%	19	0.9%
男女合計	0	0.0%	2	0.8%	0	0.0%	0	0.0%	2	0.3%	1	0.2%	2	0.5%	11	1.3%	9	1.9%	2	1.7%	29	0.7%
全体(人)																						
男性	82		123		192		238		312		196		211		432		187		43		2016	
女性	74		125		183		264		346		208		221		425		277		73		2196	
男女合計	156		248		375		502		658		404		432		857		464		116		4212	

県 北

	10	割合	20	割合	30	割合	40	割合	50	割合	64	割合	69	割合	70～	割合	全体数	割合
1と回答																		
男性	2	8.3%	1	2.1%	0	0.0%	2	3.5%	5	5.7%	2	4.1%	1	1.9%	3	2.1%	16	3.2%
女性	0	0.0%	4	8.9%	1	2.2%	2	2.9%	3	2.8%	3	6.8%	4	7.3%	10	5.3%	27	4.8%
男女合計	2	5.1%	5	5.4%	1	1.1%	4	3.2%	8	4.1%	5	5.4%	5	4.7%	13	3.9%	43	4.0%
2と回答																		
男性	2	8.3%	4	8.5%	5	11.4%	1	1.8%	10	11.5%	3	6.1%	7	13.5%	21	14.9%	53	10.6%
女性	2	13.3%	7	15.6%	6	13.3%	15	21.7%	23	21.7%	12	27.3%	13	23.6%	41	21.7%	119	21.0%
男女合計	4	10.3%	11	12.0%	11	12.4%	16	12.7%	33	17.1%	15	16.1%	20	18.7%	62	18.8%	172	16.1%
3と回答																		
男性	20	83.3%	42	89.4%	39	88.6%	54	94.7%	72	82.8%	44	89.8%	44	84.6%	116	82.3%	431	86.0%
女性	13	86.7%	33	73.3%	38	84.4%	52	75.4%	80	75.5%	29	65.9%	38	69.1%	136	72.0%	419	73.8%
男女合計	33	84.6%	75	81.5%	77	86.5%	106	84.1%	152	78.8%	73	78.5%	82	76.6%	252	76.4%	850	79.5%
無回答																		
男性	0	0.0%	0	0.0%	0	0.0%	0	0.0%	0	0.0%	0	0.0%	0	0.0%	1	0.7%	1	0.2%
女性	0	0.0%	1	2.2%	0	0.0%	0	0.0%	0	0.0%	0	0.0%	0	0.0%	2	1.1%	3	0.5%
男女合計	0	0.0%	1	1.1%	0	0.0%	0	0.0%	0	0.0%	0	0.0%	0	0.0%	3	0.9%	4	0.4%
全体(人)																		
男性	24		47		44		57		87		49		52		141		501	
女性	15		45		45		69		106		44		55		189		568	
男女合計	39		92		89		126		193		93		107		330		1069	

県 中

	10	割合	20	割合	30	割合	40	割合	50	割合	64	割合	69	割合	70～	割合	全体数	割合
1と回答																		
男性	1	4.8%	1	3.1%	1	2.0%	3	4.5%	5	5.7%	4	8.5%	0	0.0%	1	0.7%	16	3.3%
女性	1	5.0%	2	5.4%	4	7.4%	2	2.7%	9	11.4%	0	0.0%	3	6.8%	5	3.2%	26	5.0%
男女合計	2	4.9%	3	4.3%	5	4.8%	5	3.6%	14	8.4%	4	4.1%	3	3.4%	6	2.0%	42	4.2%
2と回答																		
男性	0	0.0%	3	9.4%	9	17.6%	7	10.6%	7	8.0%	5	10.6%	6	13.6%	26	18.2%	63	12.8%
女性	2	10.0%	6	16.2%	10	18.5%	15	20.5%	20	25.3%	13	26.0%	13	29.5%	34	21.5%	113	21.9%
男女合計	2	4.9%	9	13.0%	19	18.1%	22	15.8%	27	16.2%	18	18.6%	19	21.6%	60	19.9%	176	17.5%
3と回答																		
男性	20	95.2%	28	87.5%	41	80.4%	56	84.8%	74	84.1%	38	80.9%	38	86.4%	115	80.4%	410	83.3%
女性	17	85.0%	29	78.4%	40	74.1%	56	76.7%	50	63.3%	37	74.0%	28	63.6%	117	74.1%	374	72.6%
男女合計	37	90.2%	57	82.6%	81	77.1%	112	80.6%	124	74.3%	75	77.3%	66	75.0%	232	77.1%	784	77.9%
無回答																		
男性	0	0.0%	0	0.0%	0	0.0%	0	0.0%	2	2.3%	0	0.0%	0	0.0%	1	0.7%	3	0.6%
女性	0	0.0%	0	0.0%	0	0.0%	0	0.0%	0	0.0%	0	0.0%	0	0.0%	2	1.3%	2	0.4%
男女合計	0	0.0%	0	0.0%	0	0.0%	0	0.0%	2	1.2%	0	0.0%	0	0.0%	3	1.0%	5	0.5%
全体(人)																		
男性	21		32		51		66		88		47		44		143		492	
女性	20		37		54		73		79		50		44		158		515	
男女合計	41		69		105		139		167		97		88		301		1007	

県 南

	10	割合	20	割合	30	割合	40	割合	50	割合	64	割合	69	割合	70～	割合	全体数	割合
1と回答																		
男性	0	0.0%	0	0.0%	0	0.0%	0	0.0%	1	2.9%	2	9.5%	1	4.8%	1	1.3%	5	2.3%
女性	0	0.0%	0	0.0%	1	6.7%	1	3.6%	4	11.4%	0	0.0%	0	0.0%	4	4.1%	10	4.1%
男女合計	0	0.0%	0	0.0%	1	2.9%	1	2.0%	5	7.2%	2	4.3%	1	2.2%	5	2.8%	15	3.3%
2と回答																		
男性	2	16.7%	0	0.0%	1	5.0%	1	4.8%	2	5.9%	4	19.0%	2	9.5%	15	19.0%	27	12.6%
女性	4	40.0%	4	36.4%	2	13.3%	6	21.4%	7	20.0%	7	26.9%	6	25.0%	28	28.9%	64	26.0%
男女合計	6	27.3%	4	22.2%	3	8.6%	7	14.3%	9	13.0%	11	23.4%	8	17.8%	43	24.4%	91	19.7%
3と回答																		
男性	10	83.3%	7	100.0%	19	95.0%	20	95.2%	31	91.2%	15	71.4%	18	85.7%	62	78.5%	182	84.7%
女性	6	60.0%	7	63.6%	12	80.0%	21	75.0%	24	68.6%	19	73.1%	18	75.0%	61	62.9%	168	68.3%
男女合計	16	72.7%	14	77.8%	31	88.6%	41	83.7%	55	79.7%	34	72.3%	36	80.0%	123	69.9%	350	75.9%
無回答																		
男性	0	0.0%	0	0.0%	0	0.0%	0	0.0%	0	0.0%	0	0.0%	0	0.0%	1	1.3%	1	0.5%
女性	0	0.0%	0	0.0%	0	0.0%	0	0.0%	0	0.0%	0	0.0%	0	0.0%	4	4.1%	4	1.6%
男女合計	0	0.0%	0	0.0%	0	0.0%	0	0.0%	0	0.0%	0	0.0%	0	0.0%	5	2.8%	5	1.1%
全体(人)																		
男性	12		7		20		21		34		21		21		79		215	
女性	10		11		15		28		35		26		24		97		246	
男女合計	22		18		35		49		69		47		45		176		461	

会 津

	10	割合	20	割合	30	割合	40	割合	50	割合	64	割合	69	割合	70～	割合	全体数	割合
1と回答																		
男性	0	0.0%	2	11.1%	1	3.6%	2	4.7%	1	3.1%	0	0.0%	1	4.0%	3	3.0%	10	3.7%
女性	0	0.0%	2	18.2%	4	16.0%	3	7.9%	2	4.8%	1	3.6%	3	9.4%	4	3.4%	19	6.3%
男女合計	0	0.0%	4	13.8%	5	9.4%	5	6.2%	3	4.1%	1	2.0%	4	7.0%	7	3.2%	29	5.1%
2と回答																		
男性	0	0.0%	1	5.6%	3	10.7%	6	14.0%	10	31.3%	3	13.6%	3	12.0%	22	22.2%	48	17.6%
女性	3	42.9%	3	27.3%	5	20.0%	9	23.7%	8	19.0%	9	32.1%	7	21.9%	32	27.4%	76	25.3%
男女合計	3	23.1%	4	13.8%	8	15.1%	15	18.5%	18	24.3%	12	24.0%	10	17.5%	54	25.0%	124	21.6%
3と回答																		
男性	6	100.0%	14	77.8%	24	85.7%	35	81.4%	21	65.6%	19	86.4%	21	84.0%	74	74.7%	214	78.4%
女性	4	57.1%	6	54.5%	16	64.0%	26	68.4%	32	76.2%	18	64.3%	22	68.8%	79	67.5%	203	67.7%
男女合計	10	76.9%	20	69.0%	40	75.5%	61	75.3%	53	71.6%	37	74.0%	43	75.4%	153	70.8%	417	72.8%
無回答																		
男性	0	0.0%	1	5.6%	0	0.0%	0	0.0%	0	0.0%	0	0.0%	0	0.0%	0	0.0%	1	0.4%
女性	0	0.0%	0	0.0%	0	0.0%	0	0.0%	0	0.0%	0	0.0%	0	0.0%	2	1.7%	2	0.7%
男女合計	0	0.0%	1	3.4%	0	0.0%	0	0.0%	0	0.0%	0	0.0%	0	0.0%	2	0.9%	3	0.5%
全体(人)																		
男性	6		18		28		43		32		22		25		99		273	
女性	7		11		25		38		42		28		32		117		300	
男女合計	13		29		53		81		74		50		57		216		573	

南 会 津

	10	割合	20	割合	30	割合	40	割合	50	割合	64	割合	69	割合	70～	割合	全体数	割合
1と回答																		
男性	0	0.0%	0	0.0%	0	0.0%	0	0.0%	1	33.3%	0	0.0%	0	0.0%	1	7.1%	2	6.7%
女性	0	0.0%	0	0.0%	0	0.0%	0	0.0%	1	100.0%	0	0.0%	0	0.0%	0	0.0%	1	3.8%
男女合計	0	0.0%	0	0.0%	0	0.0%	0	0.0%	2	50.0%	0	0.0%	0	0.0%	1	3.7%	3	5.4%
2と回答																		
男性	0	0.0%	0	0.0%	0	0.0%	0	0.0%	0	0.0%	0	0.0%	2	50.0%	0	0.0%	2	6.7%
女性	0	0.0%	0	0.0%	1	50.0%	0	0.0%	0	0.0%	0	0.0%	2	50.0%	2	15.4%	5	19.2%
男女合計	0	0.0%	0	0.0%	1	25.0%	0	0.0%	0	0.0%	0	0.0%	4	50.0%	2	7.4%	7	12.5%
3と回答																		
男性	0	0.0%	3	100.0%	2	100.0%	3	100.0%	2	66.7%	1	100.0%	2	50.0%	13	92.9%	26	86.7%
女性	0	0.0%	0	0.0%	1	50.0%	3	100.0%	0	0.0%	3	100.0%	2	50.0%	10	76.9%	19	73.1%
男女合計	0	0.0%	3	100.0%	3	75.0%	6	100.0%	2	50.0%	4	100.0%	4	50.0%	23	85.2%	45	80.4%
無回答																		
男性	0	0.0%	0	0.0%	0	0.0%	0	0.0%	0	0.0%	0	0.0%	0	0.0%	0	0.0%	0	0.0%
女性	0	0.0%	0	0.0%	0	0.0%	0	0.0%	0	0.0%	0	0.0%	0	0.0%	1	7.7%	1	3.8%
男女合計	0	0.0%	0	0.0%	0	0.0%	0	0.0%	0	0.0%	0	0.0%	0	0.0%	1	3.7%	1	1.8%
全体(人)																		
男性	0		3		2		3		3		1		4		14		30	
女性	0		0		2		3		1		3		4		13		26	
男女合計	0		3		4		6		4		4		8		27		56	

相 双

	10	割合	20	割合	30	割合	40	割合	50	割合	64	割合	69	割合	70～	割合	全体数	割合
1と回答																		
男性	0	0.0%	1	16.7%	0	0.0%	0	0.0%	0	0.0%	0	0.0%	0	0.0%	1	1.8%	2	1.3%
女性	0	0.0%	0	0.0%	0	0.0%	3	12.5%	2	10.0%	0	0.0%	0	0.0%	6	10.0%	11	7.0%
男女合計	0	0.0%	1	10.0%	0	0.0%	3	7.1%	2	5.0%	0	0.0%	0	0.0%	7	6.0%	13	4.2%
2と回答																		
男性	1	16.7%	0	0.0%	1	8.3%	2	11.1%	4	20.0%	1	7.1%	4	20.0%	14	24.6%	27	17.6%
女性	2	33.3%	1	25.0%	3	21.4%	5	20.8%	4	20.0%	2	18.2%	4	21.1%	21	35.0%	42	26.6%
男女合計	3	25.0%	1	10.0%	4	15.4%	7	16.7%	8	20.0%	3	12.0%	8	20.5%	35	29.9%	69	22.2%
3と回答																		
男性	5	83.3%	5	83.3%	11	91.7%	16	88.9%	16	80.0%	13	92.9%	16	80.0%	41	71.9%	123	80.4%
女性	4	66.7%	3	75.0%	11	78.6%	16	66.7%	14	70.0%	9	81.8%	14	73.7%	33	55.0%	104	65.8%
男女合計	9	75.0%	8	80.0%	22	84.6%	32	76.2%	30	75.0%	22	88.0%	30	76.9%	74	63.2%	227	73.0%
無回答																		
男性	0	0.0%	0	0.0%	0	0.0%	0	0.0%	0	0.0%	0	0.0%	0	0.0%	1	1.8%	1	0.7%
女性	0	0.0%	0	0.0%	0	0.0%	0	0.0%	0	0.0%	0	0.0%	1	5.3%	0	0.0%	1	0.6%
男女合計	0	0.0%	0	0.0%	0	0.0%	0	0.0%	0	0.0%	0	0.0%	1	2.6%	1	0.9%	2	0.6%
全体(人)																		
男性	6		6		12		18		20		14		20		57		153	
女性	6		4		14		24		20		11		19		60		158	
男女合計	12		10		26		42		40		25		39		117		311	

いわき

	10	割合	20	割合	30	割合	40	割合	50	割合	64	割合	69	割合	70～	割合	全体数	割合
1と回答																		
男性	1	7.7%	1	10.0%	0	0.0%	1	3.3%	1	2.1%	0	0.0%	3	6.7%	1	0.8%	8	2.3%
女性	0	0.0%	0	0.0%	3	10.7%	0	0.0%	5	7.9%	0	0.0%	2	4.7%	5	3.5%	15	3.9%
男女合計	1	3.4%	1	3.7%	3	4.8%	1	1.7%	6	5.4%	0	0.0%	5	5.7%	6	2.2%	23	3.1%
2と回答																		
男性	1	7.7%	1	10.0%	3	8.6%	2	6.7%	5	10.4%	3	7.1%	3	6.7%	16	12.4%	34	9.7%
女性	1	6.3%	8	47.1%	3	10.7%	6	20.7%	13	20.6%	7	15.2%	9	20.9%	28	19.9%	75	19.6%
男女合計	2	6.9%	9	33.3%	6	9.5%	8	13.6%	18	16.2%	10	11.4%	12	13.6%	44	16.3%	109	14.8%
3と回答																		
男性	11	84.6%	8	80.0%	32	91.4%	27	90.0%	42	87.5%	39	92.9%	38	84.4%	110	85.3%	307	87.2%
女性	15	93.8%	9	52.9%	22	78.6%	23	79.3%	45	71.4%	38	82.6%	32	74.4%	103	73.0%	287	74.9%
男女合計	26	89.7%	17	63.0%	54	85.7%	50	84.7%	87	78.4%	77	87.5%	70	79.5%	213	78.9%	594	80.8%
無回答																		
男性	0	0.0%	0	0.0%	0	0.0%	0	0.0%	0	0.0%	0	0.0%	1	2.2%	2	1.6%	3	0.9%
女性	0	0.0%	0	0.0%	0	0.0%	0	0.0%	0	0.0%	1	2.2%	0	0.0%	5	3.5%	6	1.6%
男女合計	0	0.0%	0	0.0%	0	0.0%	0	0.0%	0	0.0%	1	1.1%	1	1.1%	7	2.6%	9	1.2%
全体(人)																		
男性	13		10		35		30		48		42		45		129		352	
女性	16		17		28		29		63		46		43		141		383	
男女合計	29		27		63		59		111		88		88		270		735	

全県（60歳以上・再掲）

	64	割合	69	割合	70	割合	80	割合	90	割合	全体数	割合
1と回答												
男性	8	4.1%	6	2.8%	6	1.4%	5	2.7%	0	0.0%	25	2.3%
女性	4	1.9%	12	5.4%	25	5.9%	8	2.9%	1	1.4%	50	4.2%
男女合計	12	3.0%	18	4.2%	31	3.6%	13	2.8%	1	0.9%	75	3.3%
2と回答												
男性	19	9.7%	27	12.8%	70	16.2%	35	18.7%	9	20.9%	160	15.0%
女性	50	24.0%	54	24.4%	111	26.1%	67	24.2%	8	11.0%	290	24.1%
男女合計	69	17.1%	81	18.8%	181	21.1%	102	22.0%	17	14.7%	450	19.8%
3と回答												
男性	169	86.2%	177	83.9%	353	81.7%	146	78.1%	32	74.4%	877	82.0%
女性	153	73.6%	154	69.7%	281	66.1%	194	70.0%	64	87.7%	846	70.3%
男女合計	322	79.7%	331	76.6%	634	74.0%	340	73.3%	96	82.8%	1723	75.8%
無回答												
男性	0	0.0%	1	0.5%	3	0.7%	1	0.5%	2	4.7%	7	0.7%
女性	1	0.5%	1	0.5%	8	1.9%	8	2.9%	0	0.0%	18	1.5%
男女合計	1	0.2%	2	0.5%	11	1.3%	9	1.9%	2	1.7%	25	1.1%
全体(人)												
男性	196		211		432		187		43		1069	
女性	208		221		425		277		73		1204	
男女合計	404		432		857		464		116		2273	

7 食生活（栄養バランス）の状況（調査票 問7）

問7 あなたは、日頃から栄養バランスのとれた食生活を実践していますか。

1 はい 2 いいえ

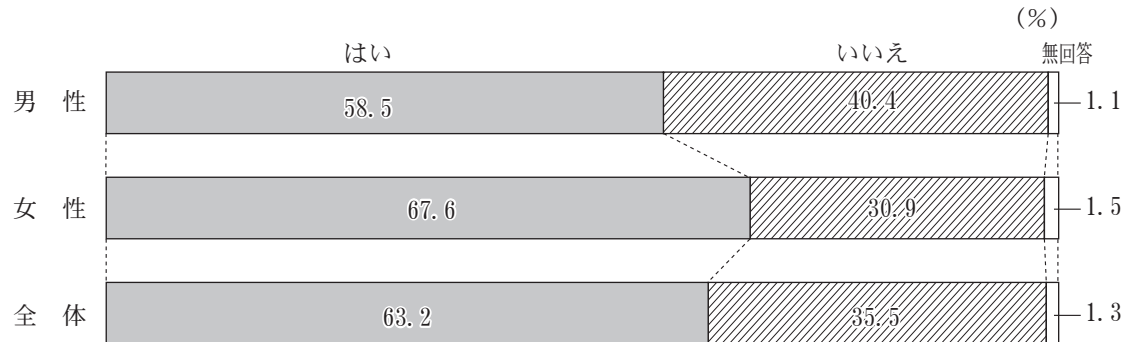

	10	割合	20	割合	30	割合	40	割合	50	割合	64	割合	69	割合	70	割合	80	割合	90	割合	全体数	割合
1と回答																						
男性	43	52.4%	66	53.7%	86	44.8%	131	55.0%	164	52.6%	114	58.2%	133	63.0%	285	66.0%	127	67.9%	30	69.8%	1179	58.5%
女性	40	54.1%	62	49.6%	100	54.6%	166	62.9%	245	70.8%	143	68.8%	166	75.1%	315	74.1%	195	70.4%	52	71.2%	1484	67.6%
男女合計	83	53.2%	128	51.6%	186	49.6%	297	59.2%	409	62.2%	257	63.6%	299	69.2%	600	70.0%	322	69.4%	82	70.7%	2663	63.2%
2と回答																						
男性	39	47.6%	57	46.3%	105	54.7%	107	45.0%	145	46.5%	80	40.8%	76	36.0%	142	32.9%	53	28.3%	11	25.6%	815	40.4%
女性	34	45.9%	61	48.8%	83	45.4%	97	36.7%	100	28.9%	63	30.3%	53	24.0%	94	22.1%	76	27.4%	18	24.7%	679	30.9%
男女合計	73	46.8%	118	47.6%	188	50.1%	204	40.6%	245	37.2%	143	35.4%	129	29.9%	236	27.5%	129	27.8%	29	25.0%	1494	35.5%
無回答																						
男性	0	0.0%	0	0.0%	1	0.5%	0	0.0%	3	1.0%	2	1.0%	2	0.9%	5	1.2%	7	3.7%	2	4.7%	22	1.1%
女性	0	0.0%	2	1.6%	0	0.0%	1	0.4%	1	0.3%	2	1.0%	2	0.9%	16	3.8%	6	2.2%	3	4.1%	33	1.5%
男女合計	0	0.0%	2	0.8%	1	0.3%	1	0.2%	4	0.6%	4	1.0%	4	0.9%	21	2.5%	13	2.8%	5	4.3%	55	1.3%
全体(人)																						
男性	82		123		192		238		312		196		211		432		187		43		2016	
女性	74		125		183		264		346		208		221		425		277		73		2196	
男女合計	156		248		375		502		658		404		432		857		464		116		4212	

県 北

	10	割合	20	割合	30	割合	40	割合	50	割合	64	割合	69	割合	70～	割合	全体数	割合
1と回答																		
男性	14	58.3%	26	55.3%	20	45.5%	28	49.1%	51	58.6%	28	57.1%	31	59.6%	94	66.7%	292	58.3%
女性	10	66.7%	26	57.8%	27	60.0%	37	53.6%	74	69.8%	35	79.5%	46	83.6%	132	69.8%	387	68.1%
男女合計	24	61.5%	52	56.5%	47	52.8%	65	51.6%	125	64.8%	63	67.7%	77	72.0%	226	68.5%	679	63.5%
2と回答																		
男性	10	41.7%	21	44.7%	24	54.5%	29	50.9%	36	41.4%	21	42.9%	21	40.4%	43	30.5%	205	40.9%
女性	5	33.3%	19	42.2%	18	40.0%	32	46.4%	32	30.2%	8	18.2%	8	14.5%	54	28.6%	176	31.0%
男女合計	15	38.5%	40	43.5%	42	47.2%	61	48.4%	68	35.2%	29	31.2%	29	27.1%	97	29.4%	381	35.6%
無回答																		
男性	0	0.0%	0	0.0%	0	0.0%	0	0.0%	0	0.0%	0	0.0%	0	0.0%	4	2.8%	4	0.8%
女性	0	0.0%	0	0.0%	0	0.0%	0	0.0%	0	0.0%	1	2.3%	1	1.8%	3	1.6%	5	0.9%
男女合計	0	0.0%	0	0.0%	0	0.0%	0	0.0%	0	0.0%	1	1.1%	1	0.9%	7	2.1%	9	0.8%
全体(人)																		
男性	24		47		44		57		87		49		52		141		501	
女性	15		45		45		69		106		44		55		189		568	
男女合計	39		92		89		126		193		93		107		330		1069	

県 中

	10	割合	20	割合	30	割合	40	割合	50	割合	64	割合	69	割合	70～	割合	全体数	割合
1と回答																		
男性	9	42.9%	16	50.0%	27	52.9%	42	63.6%	37	42.0%	29	61.7%	28	63.6%	91	63.6%	279	56.7%
女性	10	50.0%	18	48.6%	29	53.7%	50	68.5%	54	68.4%	33	66.0%	35	79.5%	115	72.8%	344	66.8%
男女合計	19	46.3%	34	49.3%	56	53.3%	92	66.2%	91	54.5%	62	63.9%	63	71.6%	206	68.4%	623	61.9%
2と回答																		
男性	12	57.1%	16	50.0%	24	47.1%	24	36.4%	48	54.5%	18	38.3%	15	34.1%	47	32.9%	204	41.5%
女性	10	50.0%	18	48.6%	25	46.3%	23	31.5%	24	30.4%	17	34.0%	9	20.5%	41	25.9%	167	32.4%
男女合計	22	53.7%	34	49.3%	49	46.7%	47	33.8%	72	43.1%	35	36.1%	24	27.3%	88	29.2%	371	36.8%
無回答																		
男性	0	0.0%	0	0.0%	0	0.0%	0	0.0%	3	3.4%	0	0.0%	1	2.3%	5	3.5%	9	1.8%
女性	0	0.0%	1	2.7%	0	0.0%	0	0.0%	1	1.3%	0	0.0%	0	0.0%	2	1.3%	4	0.8%
男女合計	0	0.0%	1	1.4%	0	0.0%	0	0.0%	4	2.4%	0	0.0%	1	1.1%	7	2.3%	13	1.3%
全体(人)																		
男性	21		32		51		66		88		47		44		143		492	
女性	20		37		54		73		79		50		44		158		515	
男女合計	41		69		105		139		167		97		88		301		1007	

県 南

	10	割合	20	割合	30	割合	40	割合	50	割合	64	割合	69	割合	70～	割合	全体数	割合
1と回答																		
男性	7	58.3%	4	57.1%	8	40.0%	11	52.4%	16	47.1%	7	33.3%	11	52.4%	48	60.8%	112	52.1%
女性	6	60.0%	5	45.5%	9	60.0%	17	60.7%	25	71.4%	19	73.1%	15	62.5%	69	71.1%	165	67.1%
男女合計	13	59.1%	9	50.0%	17	48.6%	28	57.1%	41	59.4%	26	55.3%	26	57.8%	117	66.5%	277	60.1%
2と回答																		
男性	5	41.7%	3	42.9%	12	60.0%	10	47.6%	18	52.9%	12	57.1%	9	42.9%	31	39.2%	100	46.5%
女性	4	40.0%	6	54.5%	6	40.0%	11	39.3%	10	28.6%	7	26.9%	9	37.5%	23	23.7%	76	30.9%
男女合計	9	40.9%	9	50.0%	18	51.4%	21	42.9%	28	40.6%	19	40.4%	18	40.0%	54	30.7%	176	38.2%
無回答																		
男性	0	0.0%	0	0.0%	0	0.0%	0	0.0%	0	0.0%	2	9.5%	1	4.8%	0	0.0%	3	1.4%
女性	0	0.0%	0	0.0%	0	0.0%	0	0.0%	0	0.0%	0	0.0%	0	0.0%	5	5.2%	5	2.0%
男女合計	0	0.0%	0	0.0%	0	0.0%	0	0.0%	0	0.0%	2	4.3%	1	2.2%	5	2.8%	8	1.7%
全体(人)																		
男性	12		7		20		21		34		21		21		79		215	
女性	10		11		15		28		35		26		24		97		246	
男女合計	22		18		35		49		69		47		45		176		461	

会 津

	10	割合	20	割合	30	割合	40	割合	50	割合	64	割合	69	割合	70～	割合	全体数	割合
1と回答																		
男性	1	16.7%	9	50.0%	12	42.9%	25	58.1%	15	46.9%	14	63.6%	18	72.0%	67	67.7%	161	59.0%
女性	2	28.6%	4	36.4%	15	60.0%	26	68.4%	29	69.0%	22	78.6%	23	71.9%	87	74.4%	208	69.3%
男女合計	3	23.1%	13	44.8%	27	50.9%	51	63.0%	44	59.5%	36	72.0%	41	71.9%	154	71.3%	369	64.4%
2と回答																		
男性	5	83.3%	9	50.0%	16	57.1%	18	41.9%	17	53.1%	8	36.4%	7	28.0%	32	32.3%	112	41.0%
女性	5	71.4%	7	63.6%	10	40.0%	11	28.9%	13	31.0%	6	21.4%	8	25.0%	23	19.7%	83	27.7%
男女合計	10	76.9%	16	55.2%	26	49.1%	29	35.8%	30	40.5%	14	28.0%	15	26.3%	55	25.5%	195	34.0%
無回答																		
男性	0	0.0%	0	0.0%	0	0.0%	0	0.0%	0	0.0%	0	0.0%	0	0.0%	0	0.0%	0	0.0%
女性	0	0.0%	0	0.0%	0	0.0%	1	2.6%	0	0.0%	0	0.0%	1	3.1%	7	6.0%	9	3.0%
男女合計	0	0.0%	0	0.0%	0	0.0%	1	1.2%	0	0.0%	0	0.0%	1	1.8%	7	3.2%	9	1.6%
全体(人)																		
男性	6		18		28		43		32		22		25		99		273	
女性	7		11		25		38		42		28		32		117		300	
男女合計	13		29		53		81		74		50		57		216		573	

南会津

	10	割合	20	割合	30	割合	40	割合	50	割合	64	割合	69	割合	70～	割合	全体数	割合
1と回答																		
男性	0	0.0%	1	33.3%	0	0.0%	1	33.3%	2	66.7%	1	100.0%	2	50.0%	12	85.7%	19	63.3%
女性	0	0.0%	0	0.0%	1	50.0%	1	33.3%	1	100.0%	1	33.3%	3	75.0%	8	61.5%	15	57.7%
男女合計	0	0.0%	1	33.3%	1	25.0%	2	33.3%	3	75.0%	2	50.0%	5	62.5%	20	74.1%	34	60.7%
2と回答																		
男性	0	0.0%	2	66.7%	2	100.0%	2	66.7%	1	33.3%	0	0.0%	2	50.0%	2	14.3%	11	36.7%
女性	0	0.0%	0	0.0%	1	50.0%	2	66.7%	0	0.0%	2	66.7%	1	25.0%	4	30.8%	10	38.5%
男女合計	0	0.0%	2	66.7%	3	75.0%	4	66.7%	1	25.0%	2	50.0%	3	37.5%	6	22.2%	21	37.5%
無回答																		
男性	0	0.0%	0	0.0%	0	0.0%	0	0.0%	0	0.0%	0	0.0%	0	0.0%	0	0.0%	0	0.0%
女性	0	0.0%	0	0.0%	0	0.0%	0	0.0%	0	0.0%	0	0.0%	0	0.0%	1	7.7%	1	3.8%
男女合計	0	0.0%	0	0.0%	0	0.0%	0	0.0%	0	0.0%	0	0.0%	0	0.0%	1	3.7%	1	1.8%
全体(人)																		
男性	0		3		2		3		3		1		4		14		30	
女性	0		0		2		3		1		3		4		13		26	
男女合計	0		3		4		6		4		4		8		27		56	

相 双

	10	割合	20	割合	30	割合	40	割合	50	割合	64	割合	69	割合	70～	割合	全体数	割合
1と回答																		
男性	4	66.7%	3	50.0%	6	50.0%	6	33.3%	17	85.0%	9	64.3%	12	60.0%	45	78.9%	102	66.7%
女性	2	33.3%	3	75.0%	5	35.7%	18	75.0%	15	75.0%	6	54.5%	17	89.5%	44	73.3%	110	69.6%
男女合計	6	50.0%	6	60.0%	11	42.3%	24	57.1%	32	80.0%	15	60.0%	29	74.4%	89	76.1%	212	68.2%
2と回答																		
男性	2	33.3%	3	50.0%	6	50.0%	12	66.7%	3	15.0%	5	35.7%	8	40.0%	10	17.5%	49	32.0%
女性	4	66.7%	1	25.0%	9	64.3%	6	25.0%	5	25.0%	5	45.5%	2	10.5%	13	21.7%	45	28.5%
男女合計	6	50.0%	4	40.0%	15	57.7%	18	42.9%	8	20.0%	10	40.0%	10	25.6%	23	19.7%	94	30.2%
無回答																		
男性	0	0.0%	0	0.0%	0	0.0%	0	0.0%	0	0.0%	0	0.0%	0	0.0%	2	3.5%	2	1.3%
女性	0	0.0%	0	0.0%	0	0.0%	0	0.0%	0	0.0%	0	0.0%	0	0.0%	3	5.0%	3	1.9%
男女合計	0	0.0%	0	0.0%	0	0.0%	0	0.0%	0	0.0%	0	0.0%	0	0.0%	5	4.3%	5	1.6%
全体(人)																		
男性	6		6		12		18		20		14		20		57		153	
女性	6		4		14		24		20		11		19		60		158	
男女合計	12		10		26		42		40		25		39		117		311	

いわき

	10	割合	20	割合	30	割合	40	割合	50	割合	64	割合	69	割合	70～	割合	全体数	割合
1と回答																		
男性	8	61.5%	7	70.0%	13	37.1%	18	60.0%	26	54.2%	26	61.9%	31	68.9%	85	65.9%	214	60.8%
女性	10	62.5%	6	35.3%	14	50.0%	17	58.6%	47	74.6%	27	58.7%	27	62.8%	107	75.9%	255	66.6%
男女合計	18	62.1%	13	48.1%	27	42.9%	35	59.3%	73	65.8%	53	60.2%	58	65.9%	192	71.1%	469	63.8%
2と回答																		
男性	5	38.5%	3	30.0%	21	60.0%	12	40.0%	22	45.8%	16	38.1%	14	31.1%	41	31.8%	134	38.1%
女性	6	37.5%	10	58.8%	14	50.0%	12	41.4%	16	25.4%	18	39.1%	16	37.2%	30	21.3%	122	31.9%
男女合計	11	37.9%	13	48.1%	35	55.6%	24	40.7%	38	34.2%	34	38.6%	30	34.1%	71	26.3%	256	34.8%
無回答																		
男性	0	0.0%	0	0.0%	1	2.9%	0	0.0%	0	0.0%	0	0.0%	0	0.0%	3	2.3%	4	1.1%
女性	0	0.0%	1	5.9%	0	0.0%	0	0.0%	0	0.0%	1	2.2%	0	0.0%	4	2.8%	6	1.6%
男女合計	0	0.0%	1	3.7%	1	1.6%	0	0.0%	0	0.0%	1	1.1%	0	0.0%	7	2.6%	10	1.4%
全体(人)																		
男性	13		10		35		30		48		42		45		129		352	
女性	16		17		28		29		63		46		43		141		383	
男女合計	29		27		63		59		111		88		88		270		735	

全県 (60歳以上・再掲)

	64	割合	69	割合	70	割合	80	割合	90	割合	全体数	割合
1と回答												
男性	114	58.2%	133	63.0%	285	66.0%	127	67.9%	30	69.8%	689	64.5%
女性	143	68.8%	166	75.1%	315	74.1%	195	70.4%	52	71.2%	871	72.3%
男女合計	257	63.6%	299	69.2%	600	70.0%	322	69.4%	82	70.7%	1560	68.6%
2と回答												
男性	80	40.8%	76	36.0%	142	32.9%	53	28.3%	11	25.6%	362	33.9%
女性	63	30.3%	53	24.0%	94	22.1%	76	27.4%	18	24.7%	304	25.2%
男女合計	143	35.4%	129	29.9%	236	27.5%	129	27.8%	29	25.0%	666	29.3%
無回答												
男性	2	1.0%	2	0.9%	5	1.2%	7	3.7%	2	4.7%	18	1.7%
女性	2	1.0%	2	0.9%	16	3.8%	6	2.2%	3	4.1%	29	2.4%
男女合計	4	1.0%	4	0.9%	21	2.5%	13	2.8%	5	4.3%	47	2.1%
全体(人)												
男性	196		211		432		187		43		1069	
女性	208		221		425		277		73		1204	
男女合計	404		432		857		464		116		2273	

8 「フレイル」の認知度（調査票 問8）

問8 あなたは、フレイルを知っていますか。

1 知っている 2 知らない

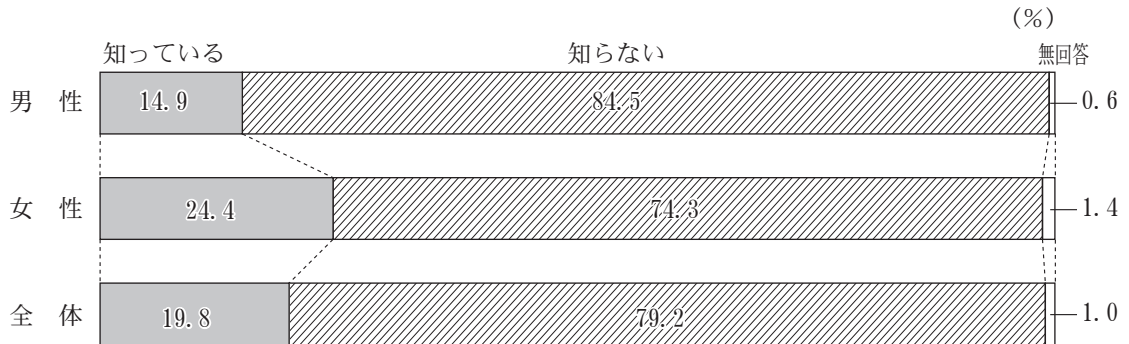

	10	割合	20	割合	30	割合	40	割合	50	割合	64	割合	69	割合	70	割合	80	割合	90	割合	全体数	割合
1と回答																						
男性	3	3.7%	20	16.3%	26	13.5%	32	13.4%	44	14.1%	19	9.7%	27	12.8%	96	22.2%	29	15.5%	4	9.3%	300	14.9%
女性	6	8.1%	23	18.4%	34	18.6%	32	12.1%	85	24.6%	53	25.5%	82	37.1%	152	35.8%	62	22.4%	6	8.2%	535	24.4%
男女合計	9	5.8%	43	17.3%	60	16.0%	64	12.7%	129	19.6%	72	17.8%	109	25.2%	248	28.9%	91	19.6%	10	8.6%	835	19.8%
2と回答																						
男性	78	95.1%	103	83.7%	166	86.5%	206	86.6%	265	84.9%	177	90.3%	183	86.7%	332	76.9%	156	83.4%	37	86.0%	1703	84.5%
女性	68	91.9%	102	81.6%	149	81.4%	232	87.9%	261	75.4%	154	74.0%	139	62.9%	264	62.1%	196	70.8%	66	90.4%	1631	74.3%
男女合計	146	93.6%	205	82.7%	315	84.0%	438	87.3%	526	79.9%	331	81.9%	322	74.5%	596	69.5%	352	75.9%	103	88.8%	3334	79.2%
無回答																						
男性	1	1.2%	0	0.0%	0	0.0%	0	0.0%	3	1.0%	0	0.0%	1	0.5%	4	0.9%	2	1.1%	2	4.7%	13	0.6%
女性	0	0.0%	0	0.0%	0	0.0%	0	0.0%	0	0.0%	1	0.5%	0	0.0%	9	2.1%	19	6.9%	1	1.4%	30	1.4%
男女合計	1	0.6%	0	0.0%	0	0.0%	0	0.0%	3	0.5%	1	0.2%	1	0.2%	13	1.5%	21	4.5%	3	2.6%	43	1.0%
全体(人)																						
男性	82		123		192		238		312		196		211		432		187		43		2016	
女性	74		125		183		264		346		208		221		425		277		73		2196	
男女合計	156		248		375		502		658		404		432		857		464		116		4212	

県 北

	10	割合	20	割合	30	割合	40	割合	50	割合	64	割合	69	割合	70～	割合	全体数	割合
1と回答																		
男性	0	0.0%	9	19.1%	5	11.4%	7	12.3%	9	10.3%	5	10.2%	6	11.5%	26	18.4%	67	13.4%
女性	2	13.3%	10	22.2%	6	13.3%	7	10.1%	29	27.4%	16	36.4%	27	49.1%	53	28.0%	150	26.4%
男女合計	2	5.1%	19	20.7%	11	12.4%	14	11.1%	38	19.7%	21	22.6%	33	30.8%	79	23.9%	217	20.3%
2と回答																		
男性	23	95.8%	38	80.9%	39	88.6%	50	87.7%	78	89.7%	44	89.8%	46	88.5%	113	80.1%	431	86.0%
女性	13	86.7%	35	77.8%	39	86.7%	62	89.9%	77	72.6%	28	63.6%	28	50.9%	131	69.3%	413	72.7%
男女合計	36	92.3%	73	79.3%	78	87.6%	112	88.9%	155	80.3%	72	77.4%	74	69.2%	244	73.9%	844	79.0%
無回答																		
男性	1	4.2%	0	0.0%	0	0.0%	0	0.0%	0	0.0%	0	0.0%	0	0.0%	2	1.4%	3	0.6%
女性	0	0.0%	0	0.0%	0	0.0%	0	0.0%	0	0.0%	0	0.0%	0	0.0%	5	2.6%	5	0.9%
男女合計	1	2.6%	0	0.0%	0	0.0%	0	0.0%	0	0.0%	0	0.0%	0	0.0%	7	2.1%	8	0.7%
全体(人)																		
男性	24		47		44		57		87		49		52		141		501	
女性	15		45		45		69		106		44		55		189		568	
男女合計	39		92		89		126		193		93		107		330		1069	

県 中

	10	割合	20	割合	30	割合	40	割合	50	割合	64	割合	69	割合	70～	割合	全体数	割合
1と回答																		
男性	2	9.5%	5	15.6%	11	21.6%	10	15.2%	12	13.6%	4	8.5%	3	6.8%	26	18.2%	73	14.8%
女性	1	5.0%	5	13.5%	12	22.2%	15	20.5%	19	24.1%	11	22.0%	19	43.2%	41	25.9%	123	23.9%
男女合計	3	7.3%	10	14.5%	23	21.9%	25	18.0%	31	18.6%	15	15.5%	22	25.0%	67	22.3%	196	19.5%
2と回答																		
男性	19	90.5%	27	84.4%	40	78.4%	56	84.8%	73	83.0%	43	91.5%	41	93.2%	115	80.4%	414	84.1%
女性	19	95.0%	32	86.5%	42	77.8%	58	79.5%	60	75.9%	39	78.0%	25	56.8%	112	70.9%	387	75.1%
男女合計	38	92.7%	59	85.5%	82	78.1%	114	82.0%	133	79.6%	82	84.5%	66	75.0%	227	75.4%	801	79.5%
無回答																		
男性	0	0.0%	0	0.0%	0	0.0%	0	0.0%	3	3.4%	0	0.0%	0	0.0%	2	1.4%	5	1.0%
女性	0	0.0%	0	0.0%	0	0.0%	0	0.0%	0	0.0%	0	0.0%	0	0.0%	5	3.2%	5	1.0%
男女合計	0	0.0%	0	0.0%	0	0.0%	0	0.0%	3	1.8%	0	0.0%	0	0.0%	7	2.3%	10	1.0%
全体(人)																		
男性	21		32		51		66		88		47		44		143		492	
女性	20		37		54		73		79		50		44		158		515	
男女合計	41		69		105		139		167		97		88		301		1007	

県 南

	10	割合	20	割合	30	割合	40	割合	50	割合	64	割合	69	割合	70～	割合	全体数	割合
1と回答																		
男性	0	0.0%	0	0.0%	2	10.0%	4	19.0%	4	11.8%	2	9.5%	5	23.8%	22	27.8%	39	18.1%
女性	1	10.0%	3	27.3%	5	33.3%	3	10.7%	5	14.3%	6	23.1%	6	25.0%	27	27.8%	56	22.8%
男女合計	1	4.5%	3	16.7%	7	20.0%	7	14.3%	9	13.0%	8	17.0%	11	24.4%	49	27.8%	95	20.6%
2と回答																		
男性	12	100.0%	7	100.0%	18	90.0%	17	81.0%	30	88.2%	19	90.5%	16	76.2%	57	72.2%	176	81.9%
女性	9	90.0%	8	72.7%	10	66.7%	25	89.3%	30	85.7%	20	76.9%	18	75.0%	67	69.1%	187	76.0%
男女合計	21	95.5%	15	83.3%	28	80.0%	42	85.7%	60	87.0%	39	83.0%	34	75.6%	124	70.5%	363	78.7%
無回答																		
男性	0	0.0%	0	0.0%	0	0.0%	0	0.0%	0	0.0%	0	0.0%	0	0.0%	0	0.0%	0	0.0%
女性	0	0.0%	0	0.0%	0	0.0%	0	0.0%	0	0.0%	0	0.0%	0	0.0%	3	3.1%	3	1.2%
男女合計	0	0.0%	0	0.0%	0	0.0%	0	0.0%	0	0.0%	0	0.0%	0	0.0%	3	1.7%	3	0.7%
全体(人)																		
男性	12		7		20		21		34		21		21		79		215	
女性	10		11		15		28		35		26		24		97		246	
男女合計	22		18		35		49		69		47		45		176		461	

会 津

	10	割合	20	割合	30	割合	40	割合	50	割合	64	割合	69	割合	70～	割合	全体数	割合
1と回答																		
男性	0	0.0%	4	22.2%	6	21.4%	4	9.3%	10	31.3%	4	18.2%	2	8.0%	23	23.2%	53	19.4%
女性	0	0.0%	1	9.1%	5	20.0%	2	5.3%	14	33.3%	9	32.1%	6	18.8%	32	27.4%	69	23.0%
男女合計	0	0.0%	5	17.2%	11	20.8%	6	7.4%	24	32.4%	13	26.0%	8	14.0%	55	25.5%	122	21.3%
2と回答																		
男性	6	100.0%	14	77.8%	22	78.6%	39	90.7%	22	68.8%	18	81.8%	22	88.0%	74	74.7%	217	79.5%
女性	7	100.0%	10	90.9%	20	80.0%	36	94.7%	28	66.7%	19	67.9%	26	81.3%	79	67.5%	225	75.0%
男女合計	13	100.0%	24	82.8%	42	79.2%	75	92.6%	50	67.6%	37	74.0%	48	84.2%	153	70.8%	442	77.1%
無回答																		
男性	0	0.0%	0	0.0%	0	0.0%	0	0.0%	0	0.0%	0	0.0%	1	4.0%	2	2.0%	3	1.1%
女性	0	0.0%	0	0.0%	0	0.0%	0	0.0%	0	0.0%	0	0.0%	0	0.0%	6	5.1%	6	2.0%
男女合計	0	0.0%	0	0.0%	0	0.0%	0	0.0%	0	0.0%	0	0.0%	1	1.8%	8	3.7%	9	1.6%
全体(人)																		
男性	6		18		28		43		32		22		25		99		273	
女性	7		11		25		38		42		28		32		117		300	
男女合計	13		29		53		81		74		50		57		216		573	

南会津

	10	割合	20	割合	30	割合	40	割合	50	割合	64	割合	69	割合	70～	割合	全体数	割合
1と回答																		
男性	0	0.0%	0	0.0%	0	0.0%	0	0.0%	1	33.3%	0	0.0%	0	0.0%	1	7.1%	2	6.7%
女性	0	0.0%	0	0.0%	0	0.0%	0	0.0%	1	100.0%	0	0.0%	0	0.0%	4	30.8%	5	19.2%
男女合計	0	0.0%	0	0.0%	0	0.0%	0	0.0%	2	50.0%	0	0.0%	0	0.0%	5	18.5%	7	12.5%
2と回答																		
男性	0	0.0%	3	100.0%	2	100.0%	3	100.0%	2	66.7%	1	100.0%	4	100.0%	13	92.9%	28	93.3%
女性	0	0.0%	0	0.0%	2	100.0%	3	100.0%	0	0.0%	3	100.0%	4	100.0%	8	61.5%	20	76.9%
男女合計	0	0.0%	3	100.0%	4	100.0%	6	100.0%	2	50.0%	4	100.0%	8	100.0%	21	77.8%	48	85.7%
無回答																		
男性	0	0.0%	0	0.0%	0	0.0%	0	0.0%	0	0.0%	0	0.0%	0	0.0%	0	0.0%	0	0.0%
女性	0	0.0%	0	0.0%	0	0.0%	0	0.0%	0	0.0%	0	0.0%	0	0.0%	1	7.7%	1	3.8%
男女合計	0	0.0%	0	0.0%	0	0.0%	0	0.0%	0	0.0%	0	0.0%	0	0.0%	1	3.7%	1	1.8%
全体(人)																		
男性	0		3		2		3		3		1		4		14		30	
女性	0		0		2		3		1		3		4		13		26	
男女合計	0		3		4		6		4		4		8		27		56	

相 双

	10	割合	20	割合	30	割合	40	割合	50	割合	64	割合	69	割合	70～	割合	全体数	割合
1と回答																		
男性	0	0.0%	1	16.7%	0	0.0%	3	16.7%	1	5.0%	2	14.3%	4	20.0%	7	12.3%	18	11.8%
女性	0	0.0%	0	0.0%	1	7.1%	2	8.3%	3	15.0%	4	36.4%	6	31.6%	15	25.0%	31	19.6%
男女合計	0	0.0%	1	10.0%	1	3.8%	5	11.9%	4	10.0%	6	24.0%	10	25.6%	22	18.8%	49	15.8%
2と回答																		
男性	6	100.0%	5	83.3%	12	100.0%	15	83.3%	19	95.0%	12	85.7%	16	80.0%	49	86.0%	134	87.6%
女性	6	100.0%	4	100.0%	13	92.9%	22	91.7%	17	85.0%	7	63.6%	13	68.4%	43	71.7%	125	79.1%
男女合計	12	100.0%	9	90.0%	25	96.2%	37	88.1%	36	90.0%	19	76.0%	29	74.4%	92	78.6%	259	83.3%
無回答																		
男性	0	0.0%	0	0.0%	0	0.0%	0	0.0%	0	0.0%	0	0.0%	0	0.0%	1	1.8%	1	0.7%
女性	0	0.0%	0	0.0%	0	0.0%	0	0.0%	0	0.0%	0	0.0%	0	0.0%	2	3.3%	2	1.3%
男女合計	0	0.0%	0	0.0%	0	0.0%	0	0.0%	0	0.0%	0	0.0%	0	0.0%	3	2.6%	3	1.0%
全体(人)																		
男性	6		6		12		18		20		14		20		57		153	
女性	6		4		14		24		20		11		19		60		158	
男女合計	12		10		26		42		40		25		39		117		311	

いわき

	10	割合	20	割合	30	割合	40	割合	50	割合	64	割合	69	割合	70～	割合	全体数	割合
1と回答																		
男性	1	7.7%	1	10.0%	2	5.7%	4	13.3%	7	14.6%	2	4.8%	7	15.6%	24	18.6%	48	13.6%
女性	2	12.5%	4	23.5%	5	17.9%	3	10.3%	14	22.2%	7	15.2%	18	41.9%	48	34.0%	101	26.4%
男女合計	3	10.3%	5	18.5%	7	11.1%	7	11.9%	21	18.9%	9	10.2%	25	28.4%	72	26.7%	149	20.3%
2と回答																		
男性	12	92.3%	9	90.0%	33	94.3%	26	86.7%	41	85.4%	40	95.2%	38	84.4%	104	80.6%	303	86.1%
女性	14	87.5%	13	76.5%	23	82.1%	26	89.7%	49	77.8%	38	82.6%	25	58.1%	86	61.0%	274	71.5%
男女合計	26	89.7%	22	81.5%	56	88.9%	52	88.1%	90	81.1%	78	88.6%	63	71.6%	190	70.4%	577	78.5%
無回答																		
男性	0	0.0%	0	0.0%	0	0.0%	0	0.0%	0	0.0%	0	0.0%	0	0.0%	1	0.8%	1	0.3%
女性	0	0.0%	0	0.0%	0	0.0%	0	0.0%	0	0.0%	1	2.2%	0	0.0%	7	5.0%	8	2.1%
男女合計	0	0.0%	0	0.0%	0	0.0%	0	0.0%	0	0.0%	1	1.1%	0	0.0%	8	3.0%	9	1.2%
全体(人)																		
男性	13		10		35		30		48		42		45		129		352	
女性	16		17		28		29		63		46		43		141		383	
男女合計	29		27		63		59		111		88		88		270		735	

全県(60歳以上・再掲)

	64	割合	69	割合	70	割合	80	割合	90	割合	全体数	割合
1と回答												
男性	19	9.7%	27	12.8%	96	22.2%	29	15.5%	4	9.3%	175	16.4%
女性	53	25.5%	82	37.1%	152	35.8%	62	22.4%	6	8.2%	355	29.5%
男女合計	72	17.8%	109	25.2%	248	28.9%	91	19.6%	10	8.6%	530	23.3%
2と回答												
男性	177	90.3%	183	86.7%	332	76.9%	156	83.4%	37	86.0%	885	82.8%
女性	154	74.0%	139	62.9%	264	62.1%	196	70.8%	66	90.4%	819	68.0%
男女合計	331	81.9%	322	74.5%	596	69.5%	352	75.9%	103	88.8%	1704	75.0%
無回答												
男性	0	0.0%	1	0.5%	4	0.9%	2	1.1%	2	4.7%	9	0.8%
女性	1	0.5%	0	0.0%	9	2.1%	19	6.9%	1	1.4%	30	2.5%
男女合計	1	0.2%	1	0.2%	13	1.5%	21	4.5%	3	2.6%	39	1.7%
全体(人)												
男性	196		211		432		187		43		1069	
女性	208		221		425		277		73		1204	
男女合計	404		432		857		464		116		2273	

9 「ロコモティブシンドローム」の認知度（調査票 問9）

問9 あなたは、ロコモティブシンドローム（運動器症候群）を知っていますか。

1 知っている 2 知らない

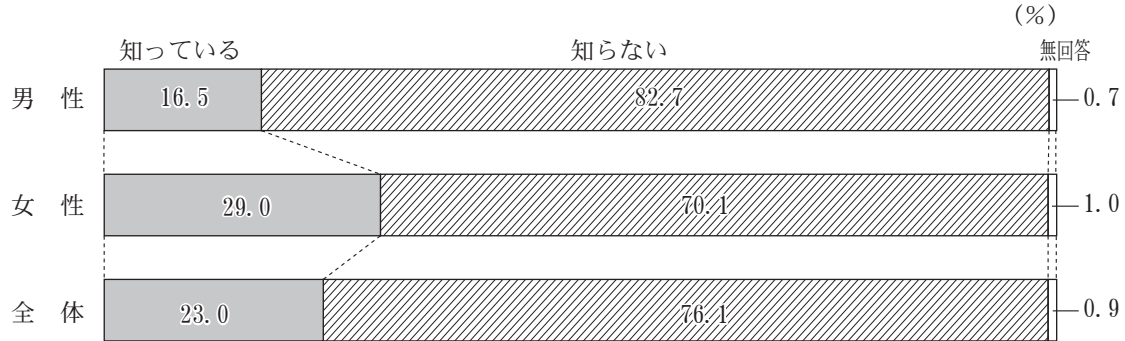

	10	割合	20	割合	30	割合	40	割合	50	割合	64	割合	69	割合	70	割合	80	割合	90	割合	全体数	割合
1と回答																						
男性	10	12.2%	24	19.5%	32	16.7%	42	17.6%	58	18.6%	24	12.2%	29	13.7%	84	19.4%	28	15.0%	2	4.7%	333	16.5%
女性	10	13.5%	27	21.6%	44	24.0%	65	24.6%	113	32.7%	74	35.6%	87	39.4%	152	35.8%	56	20.2%	8	11.0%	636	29.0%
男女合計	20	12.8%	51	20.6%	76	20.3%	107	21.3%	171	26.0%	98	24.3%	116	26.9%	236	27.5%	84	18.1%	10	8.6%	969	23.0%
2と回答																						
男性	72	87.8%	99	80.5%	160	83.3%	196	82.4%	251	80.4%	170	86.7%	181	85.8%	343	79.4%	158	84.5%	38	88.4%	1668	82.7%
女性	64	86.5%	98	78.4%	139	76.0%	199	75.4%	233	67.3%	133	63.9%	133	60.2%	265	62.4%	210	75.8%	65	89.0%	1539	70.1%
男女合計	136	87.2%	197	79.4%	299	79.7%	395	78.7%	484	73.6%	303	75.0%	314	72.7%	608	70.9%	368	79.3%	103	88.8%	3207	76.1%
無回答																						
男性	0	0.0%	0	0.0%	0	0.0%	0	0.0%	3	1.0%	2	1.0%	1	0.5%	5	1.2%	1	0.5%	3	7.0%	15	0.7%
女性	0	0.0%	0	0.0%	0	0.0%	0	0.0%	0	0.0%	1	0.5%	1	0.5%	8	1.9%	11	4.0%	0	0.0%	21	1.0%
男女合計	0	0.0%	0	0.0%	0	0.0%	0	0.0%	3	0.5%	3	0.7%	2	0.5%	13	1.5%	12	2.6%	3	2.6%	36	0.9%
全体(人)																						
男性	82		123		192		238		312		196		211		432		187		43		2016	
女性	74		125		183		264		346		208		221		425		277		73		2196	
男女合計	156		248		375		502		658		404		432		857		464		116		4212	

県 北

	10	割合	20	割合	30	割合	40	割合	50	割合	64	割合	69	割合	70～	割合	全体数	割合
1と回答																		
男性	3	12.5%	14	29.8%	4	9.1%	9	15.8%	15	17.2%	7	14.3%	10	19.2%	23	16.3%	85	17.0%
女性	3	20.0%	10	22.2%	9	20.0%	15	21.7%	35	33.0%	23	52.3%	22	40.0%	49	25.9%	166	29.2%
男女合計	6	15.4%	24	26.1%	13	14.6%	24	19.0%	50	25.9%	30	32.3%	32	29.9%	72	21.8%	251	23.5%
2と回答																		
男性	21	87.5%	33	70.2%	40	90.9%	48	84.2%	72	82.8%	41	83.7%	42	80.8%	117	83.0%	414	82.6%
女性	12	80.0%	35	77.8%	36	80.0%	54	78.3%	71	67.0%	21	47.7%	33	60.0%	136	72.0%	398	70.1%
男女合計	33	84.6%	68	73.9%	76	85.4%	102	81.0%	143	74.1%	62	66.7%	75	70.1%	253	76.7%	812	76.0%
無回答																		
男性	0	0.0%	0	0.0%	0	0.0%	0	0.0%	0	0.0%	1	2.0%	0	0.0%	1	0.7%	2	0.4%
女性	0	0.0%	0	0.0%	0	0.0%	0	0.0%	0	0.0%	0	0.0%	0	0.0%	4	2.1%	4	0.7%
男女合計	0	0.0%	0	0.0%	0	0.0%	0	0.0%	0	0.0%	1	1.1%	0	0.0%	5	1.5%	6	0.6%
全体(人)																		
男性	24		47		44		57		87		49		52		141		501	
女性	15		45		45		69		106		44		55		189		568	
男女合計	39		92		89		126		193		93		107		330		1069	

県 中

	10	割合	20	割合	30	割合	40	割合	50	割合	64	割合	69	割合	70～	割合	全体数	割合
1と回答																		
男性	2	9.5%	4	12.5%	13	25.5%	13	19.7%	17	19.3%	7	14.9%	6	13.6%	30	21.0%	92	18.7%
女性	2	10.0%	8	21.6%	11	20.4%	24	32.9%	32	40.5%	18	36.0%	19	43.2%	51	32.3%	165	32.0%
男女合計	4	9.8%	12	17.4%	24	22.9%	37	26.6%	49	29.3%	25	25.8%	25	28.4%	81	26.9%	257	25.5%
2と回答																		
男性	19	90.5%	28	87.5%	38	74.5%	53	80.3%	68	77.3%	40	85.1%	38	86.4%	111	77.6%	395	80.3%
女性	18	90.0%	29	78.4%	43	79.6%	49	67.1%	47	59.5%	32	64.0%	25	56.8%	104	65.8%	347	67.4%
男女合計	37	90.2%	57	82.6%	81	77.1%	102	73.4%	115	68.9%	72	74.2%	63	71.6%	215	71.4%	742	73.7%
無回答																		
男性	0	0.0%	0	0.0%	0	0.0%	0	0.0%	3	3.4%	0	0.0%	0	0.0%	2	1.4%	5	1.0%
女性	0	0.0%	0	0.0%	0	0.0%	0	0.0%	0	0.0%	0	0.0%	0	0.0%	3	1.9%	3	0.6%
男女合計	0	0.0%	0	0.0%	0	0.0%	0	0.0%	3	1.8%	0	0.0%	0	0.0%	5	1.7%	8	0.8%
全体(人)																		
男性	21		32		51		66		88		47		44		143		492	
女性	20		37		54		73		79		50		44		158		515	
男女合計	41		69		105		139		167		97		88		301		1007	

県 南

	10	割合	20	割合	30	割合	40	割合	50	割合	64	割合	69	割合	70～	割合	全体数	割合
1と回答																		
男性	1	8.3%	0	0.0%	3	15.0%	4	19.0%	4	11.8%	1	4.8%	2	9.5%	12	15.2%	27	12.6%
女性	1	10.0%	2	18.2%	5	33.3%	5	17.9%	9	25.7%	7	26.9%	8	33.3%	21	21.6%	58	23.6%
男女合計	2	9.1%	2	11.1%	8	22.9%	9	18.4%	13	18.8%	8	17.0%	10	22.2%	33	18.8%	85	18.4%
2と回答																		
男性	11	91.7%	7	100.0%	17	85.0%	17	81.0%	30	88.2%	20	95.2%	19	90.5%	65	82.3%	186	86.5%
女性	9	90.0%	9	81.8%	10	66.7%	23	82.1%	26	74.3%	19	73.1%	16	66.7%	71	73.2%	183	74.4%
男女合計	20	90.9%	16	88.9%	27	77.1%	40	81.6%	56	81.2%	39	83.0%	35	77.8%	136	77.3%	369	80.0%
無回答																		
男性	0	0.0%	0	0.0%	0	0.0%	0	0.0%	0	0.0%	0	0.0%	0	0.0%	2	2.5%	2	0.9%
女性	0	0.0%	0	0.0%	0	0.0%	0	0.0%	0	0.0%	0	0.0%	0	0.0%	5	5.2%	5	2.0%
男女合計	0	0.0%	0	0.0%	0	0.0%	0	0.0%	0	0.0%	0	0.0%	0	0.0%	7	4.0%	7	1.5%
全体(人)																		
男性	12		7		20		21		34		21		21		79		215	
女性	10		11		15		28		35		26		24		97		246	
男女合計	22		18		35		49		69		47		45		176		461	

会 津

	10	割合	20	割合	30	割合	40	割合	50	割合	64	割合	69	割合	70～	割合	全体数	割合
1と回答																		
男性	0	0.0%	4	22.2%	8	28.6%	7	16.3%	12	37.5%	2	9.1%	2	8.0%	21	21.2%	56	20.5%
女性	2	28.6%	2	18.2%	13	52.0%	7	18.4%	16	38.1%	12	42.9%	14	43.8%	34	29.1%	100	33.3%
男女合計	2	15.4%	6	20.7%	21	39.6%	14	17.3%	28	37.8%	14	28.0%	16	28.1%	55	25.5%	156	27.2%
2と回答																		
男性	6	100.0%	14	77.8%	20	71.4%	36	83.7%	20	62.5%	20	90.9%	22	88.0%	77	77.8%	215	78.8%
女性	5	71.4%	9	81.8%	12	48.0%	31	81.6%	26	61.9%	16	57.1%	18	56.3%	80	68.4%	197	65.7%
男女合計	11	84.6%	23	79.3%	32	60.4%	67	82.7%	46	62.2%	36	72.0%	40	70.2%	157	72.7%	412	71.9%
無回答																		
男性	0	0.0%	0	0.0%	0	0.0%	0	0.0%	0	0.0%	0	0.0%	1	4.0%	1	1.0%	2	0.7%
女性	0	0.0%	0	0.0%	0	0.0%	0	0.0%	0	0.0%	0	0.0%	0	0.0%	3	2.6%	3	1.0%
男女合計	0	0.0%	0	0.0%	0	0.0%	0	0.0%	0	0.0%	0	0.0%	1	1.8%	4	1.9%	5	0.9%
全体(人)																		
男性	6		18		28		43		32		22		25		99		273	
女性	7		11		25		38		42		28		32		117		300	
男女合計	13		29		53		81		74		50		57		216		573	

南会津

	10	割合	20	割合	30	割合	40	割合	50	割合	64	割合	69	割合	70～	割合	全体数	割合
1と回答																		
男性	0	0.0%	0	0.0%	0	0.0%	1	33.3%	2	66.7%	0	0.0%	0	0.0%	0	0.0%	3	10.0%
女性	0	0.0%	0	0.0%	0	0.0%	1	33.3%	1	100.0%	0	0.0%	1	25.0%	5	38.5%	8	30.8%
男女合計	0	0.0%	0	0.0%	0	0.0%	2	33.3%	3	75.0%	0	0.0%	1	12.5%	5	18.5%	11	19.6%
2と回答																		
男性	0	0.0%	3	100.0%	2	100.0%	2	66.7%	1	33.3%	1	100.0%	4	100.0%	14	100.0%	27	90.0%
女性	0	0.0%	0	0.0%	2	100.0%	2	66.7%	0	0.0%	3	100.0%	3	75.0%	7	53.8%	17	65.4%
男女合計	0	0.0%	3	100.0%	4	100.0%	4	66.7%	1	25.0%	4	100.0%	7	87.5%	21	77.8%	44	78.6%
無回答																		
男性	0	0.0%	0	0.0%	0	0.0%	0	0.0%	0	0.0%	0	0.0%	0	0.0%	0	0.0%	0	0.0%
女性	0	0.0%	0	0.0%	0	0.0%	0	0.0%	0	0.0%	0	0.0%	0	0.0%	1	7.7%	1	3.8%
男女合計	0	0.0%	0	0.0%	0	0.0%	0	0.0%	0	0.0%	0	0.0%	0	0.0%	1	3.7%	1	1.8%
全体(人)																		
男性	0		3		2		3		3		1		4		14		30	
女性	0		0		2		3		1		3		4		13		26	
男女合計	0		3		4		6		4		4		8		27		56	

相 双

	10	割合	20	割合	30	割合	40	割合	50	割合	64	割合	69	割合	70～	割合	全体数	割合
1と回答																		
男性	1	16.7%	1	16.7%	1	8.3%	5	27.8%	4	20.0%	2	14.3%	2	10.0%	11	19.3%	27	17.6%
女性	1	16.7%	0	0.0%	1	7.1%	7	29.2%	6	30.0%	4	36.4%	9	47.4%	15	25.0%	43	27.2%
男女合計	2	16.7%	1	10.0%	2	7.7%	12	28.6%	10	25.0%	6	24.0%	11	28.2%	26	22.2%	70	22.5%
2と回答																		
男性	5	83.3%	5	83.3%	11	91.7%	13	72.2%	16	80.0%	12	85.7%	18	90.0%	44	77.2%	124	81.0%
女性	5	83.3%	4	100.0%	13	92.9%	17	70.8%	14	70.0%	7	63.6%	10	52.6%	43	71.7%	113	71.5%
男女合計	10	83.3%	9	90.0%	24	92.3%	30	71.4%	30	75.0%	19	76.0%	28	71.8%	87	74.4%	237	76.2%
無回答																		
男性	0	0.0%	0	0.0%	0	0.0%	0	0.0%	0	0.0%	0	0.0%	0	0.0%	2	3.5%	2	1.3%
女性	0	0.0%	0	0.0%	0	0.0%	0	0.0%	0	0.0%	0	0.0%	0	0.0%	2	3.3%	2	1.3%
男女合計	0	0.0%	0	0.0%	0	0.0%	0	0.0%	0	0.0%	0	0.0%	0	0.0%	4	3.4%	4	1.3%
全体(人)																		
男性	6		6		12		18		20		14		20		57		153	
女性	6		4		14		24		20		11		19		60		158	
男女合計	12		10		26		42		40		25		39		117		311	

いわき

	10	割合	20	割合	30	割合	40	割合	50	割合	64	割合	69	割合	70～	割合	全体数	割合
1と回答																		
男性	3	23.1%	1	10.0%	3	8.6%	3	10.0%	4	8.3%	5	11.9%	7	15.6%	17	13.2%	43	12.2%
女性	1	6.3%	5	29.4%	5	17.9%	6	20.7%	14	22.2%	10	21.7%	14	32.6%	41	29.1%	96	25.1%
男女合計	4	13.8%	6	22.2%	8	12.7%	9	15.3%	18	16.2%	15	17.0%	21	23.9%	58	21.5%	139	18.9%
2と回答																		
男性	10	76.9%	9	90.0%	32	91.4%	27	90.0%	44	91.7%	36	85.7%	38	84.4%	111	86.0%	307	87.2%
女性	15	93.8%	12	70.6%	23	82.1%	23	79.3%	49	77.8%	35	76.1%	28	65.1%	99	70.2%	284	74.2%
男女合計	25	86.2%	21	77.8%	55	87.3%	50	84.7%	93	83.8%	71	80.7%	66	75.0%	210	77.8%	591	80.4%
無回答																		
男性	0	0.0%	0	0.0%	0	0.0%	0	0.0%	0	0.0%	1	2.4%	0	0.0%	1	0.8%	2	0.6%
女性	0	0.0%	0	0.0%	0	0.0%	0	0.0%	0	0.0%	1	2.2%	1	2.3%	1	0.7%	3	0.8%
男女合計	0	0.0%	0	0.0%	0	0.0%	0	0.0%	0	0.0%	2	2.3%	1	1.1%	2	0.7%	5	0.7%
全体(人)																		
男性	13		10		35		30		48		42		45		129		352	
女性	16		17		28		29		63		46		43		141		383	
男女合計	29		27		63		59		111		88		88		270		735	

全県 (60歳以上・再掲)

	64	割合	69	割合	70	割合	80	割合	90	割合	全体数	割合
1と回答												
男性	24	12.2%	29	13.7%	84	19.4%	28	15.0%	2	4.7%	167	15.6%
女性	74	35.6%	87	39.4%	152	35.8%	56	20.2%	8	11.0%	377	31.3%
男女合計	98	24.3%	116	26.9%	236	27.5%	84	18.1%	10	8.6%	544	23.9%
2と回答												
男性	170	86.7%	181	85.8%	343	79.4%	158	84.5%	38	88.4%	890	83.3%
女性	133	63.9%	133	60.2%	265	62.4%	210	75.8%	65	89.0%	806	66.9%
男女合計	303	75.0%	314	72.7%	608	70.9%	368	79.3%	103	88.8%	1696	74.6%
無回答												
男性	2	1.0%	1	0.5%	5	1.2%	1	0.5%	3	7.0%	12	1.1%
女性	1	0.5%	1	0.5%	8	1.9%	11	4.0%	0	0.0%	21	1.7%
男女合計	3	0.7%	2	0.5%	13	1.5%	12	2.6%	3	2.6%	33	1.5%
全体(人)												
男性	196		211		432		187		43		1069	
女性	208		221		425		277		73		1204	
男女合計	404		432		857		464		116		2273	

10 最近1年間の運動状況（調査票 問10）

（1）運動の状況

問10 最近1年間の運動について、あてはまるものを1つ選んで○をつけてください。

- 1 何らかの運動をほとんど毎日している。
- 2 何らかの運動を週2～4回程度している。
- 3 何らかの運動を週1回程度している。
- 4 ほとんど（まったく）していない。

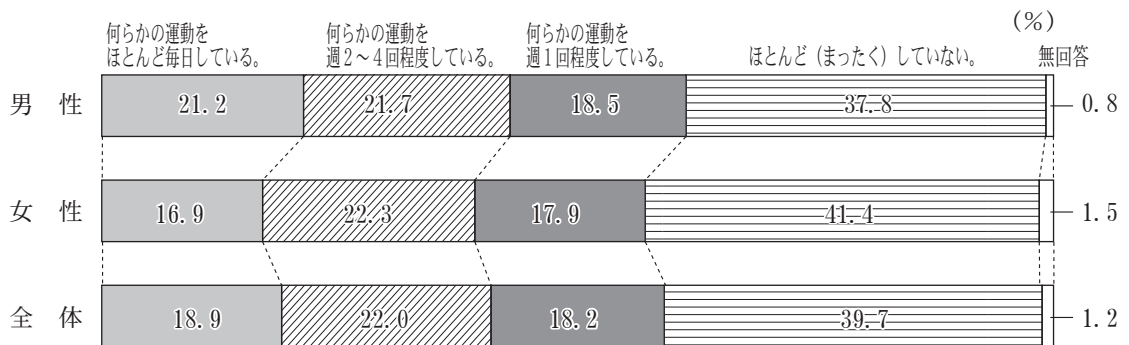

	10	割合	20	割合	30	割合	40	割合	50	割合	64	割合	69	割合	70	割合	80	割合	90	割合	全体数	割合
1と回答																						
男性	33	40.2%	23	18.7%	29	15.1%	28	11.8%	45	14.4%	38	19.4%	47	22.3%	123	28.5%	54	28.9%	7	16.3%	427	21.2%
女性	14	18.9%	16	12.8%	15	8.2%	18	6.8%	62	17.9%	39	18.8%	42	19.0%	90	21.2%	67	24.2%	8	11.0%	371	16.9%
男女合計	47	30.1%	39	15.7%	44	11.7%	46	9.2%	107	16.3%	77	19.1%	89	20.6%	213	24.9%	121	26.1%	15	12.9%	798	18.9%
2と回答																						
男性	23	28.0%	29	23.6%	38	19.8%	43	18.1%	47	15.1%	42	21.4%	54	25.6%	113	26.2%	42	22.5%	7	16.3%	438	21.7%
女性	24	32.4%	22	17.6%	28	15.3%	44	16.7%	58	16.8%	45	21.6%	70	31.7%	136	32.0%	55	19.9%	8	11.0%	490	22.3%
男女合計	47	30.1%	51	20.6%	66	17.6%	87	17.3%	105	16.0%	87	21.5%	124	28.7%	249	29.1%	97	20.9%	15	12.9%	928	22.0%
3と回答																						
男性	15	18.3%	28	22.8%	38	19.8%	40	16.8%	64	20.5%	35	17.9%	34	16.1%	76	17.6%	33	17.6%	9	20.9%	372	18.5%
女性	14	18.9%	24	19.2%	32	17.5%	46	17.4%	66	19.1%	34	16.3%	39	17.6%	73	17.2%	55	19.9%	10	13.7%	393	17.9%
男女合計	29	18.6%	52	21.0%	70	18.7%	86	17.1%	130	19.8%	69	17.1%	73	16.9%	149	17.4%	88	19.0%	19	16.4%	765	18.2%
4と回答																						
男性	11	13.4%	43	35.0%	87	45.3%	126	52.9%	152	48.7%	80	40.8%	76	36.0%	116	26.9%	54	28.9%	18	41.9%	763	37.8%
女性	22	29.7%	62	49.6%	108	59.0%	155	58.7%	159	46.0%	87	41.8%	67	30.3%	115	27.1%	89	32.1%	45	61.6%	909	41.4%
男女合計	33	21.2%	105	42.3%	195	52.0%	281	56.0%	311	47.3%	167	41.3%	143	33.1%	231	27.0%	143	30.8%	63	54.3%	1672	39.7%
無回答																						
男性	0	0.0%	0	0.0%	0	0.0%	1	0.4%	4	1.3%	1	0.5%	0	0.0%	4	0.9%	4	2.1%	2	4.7%	16	0.8%
女性	0	0.0%	1	0.8%	0	0.0%	1	0.4%	1	0.3%	3	1.4%	3	1.4%	11	2.6%	11	4.0%	2	2.7%	33	1.5%
男女合計	0	0.0%	1	0.4%	0	0.0%	2	0.4%	5	0.8%	4	1.0%	3	0.7%	15	1.8%	15	3.2%	4	3.4%	49	1.2%
全体(人)																						
男性	82		123		192		238		312		196		211		432		187		43		2016	
女性	74		125		183		264		346		208		221		425		277		73		2196	
男女合計	156		248		375		502		658		404		432		857		464		116		4212	

県 北

	10	割合	20	割合	30	割合	40	割合	50	割合	64	割合	69	割合	70～	割合	全体数	割合
1と回答																		
男性	9	37.5%	9	19.1%	9	20.5%	4	7.0%	8	9.2%	8	16.3%	11	21.2%	38	27.0%	96	19.2%
女性	1	6.7%	4	8.9%	4	8.9%	2	2.9%	22	20.8%	8	18.2%	11	20.0%	37	19.6%	89	15.7%
男女合計	10	25.6%	13	14.1%	13	14.6%	6	4.8%	30	15.5%	16	17.2%	22	20.6%	75	22.7%	185	17.3%
2と回答																		
男性	8	33.3%	14	29.8%	8	18.2%	8	14.0%	18	20.7%	6	12.2%	13	25.0%	39	27.7%	114	22.8%
女性	7	46.7%	7	15.6%	8	17.8%	11	15.9%	11	10.4%	13	29.5%	17	30.9%	48	25.4%	122	21.5%
男女合計	15	38.5%	21	22.8%	16	18.0%	19	15.1%	29	15.0%	19	20.4%	30	28.0%	87	26.4%	236	22.1%
3と回答																		
男性	3	12.5%	10	21.3%	4	9.1%	5	8.8%	23	26.4%	10	20.4%	7	13.5%	21	14.9%	83	16.6%
女性	2	13.3%	10	22.2%	8	17.8%	14	20.3%	26	24.5%	6	13.6%	10	18.2%	28	14.8%	104	18.3%
男女合計	5	12.8%	20	21.7%	12	13.5%	19	15.1%	49	25.4%	16	17.2%	17	15.9%	49	14.8%	187	17.5%
4と回答																		
男性	4	16.7%	14	29.8%	23	52.3%	39	68.4%	37	42.5%	25	51.0%	21	40.4%	43	30.5%	206	41.1%
女性	5	33.3%	23	51.1%	25	55.6%	42	60.9%	47	44.3%	17	38.6%	16	29.1%	72	38.1%	247	43.5%
男女合計	9	23.1%	37	40.2%	48	53.9%	81	64.3%	84	43.5%	42	45.2%	37	34.6%	115	34.8%	453	42.4%
無回答																		
男性	0	0.0%	0	0.0%	0	0.0%	1	1.8%	1	1.1%	0	0.0%	0	0.0%	0	0.0%	2	0.4%
女性	0	0.0%	1	2.2%	0	0.0%	0	0.0%	0	0.0%	0	0.0%	1	1.8%	4	2.1%	6	1.1%
男女合計	0	0.0%	1	1.1%	0	0.0%	1	0.8%	1	0.5%	0	0.0%	1	0.9%	4	1.2%	8	0.7%
全体(人)																		
男性	24		47		44		57		87		49		52		141		501	
女性	15		45		45		69		106		44		55		189		568	
男女合計	39		92		89		126		193		93		107		330		1069	

県 中

	10	割合	20	割合	30	割合	40	割合	50	割合	64	割合	69	割合	70～	割合	全体数	割合
1と回答																		
男性	6	28.6%	2	6.3%	8	15.7%	8	12.1%	13	14.8%	8	17.0%	14	31.8%	41	28.7%	100	20.3%
女性	5	25.0%	7	18.9%	4	7.4%	8	11.0%	12	15.2%	8	16.0%	11	25.0%	20	12.7%	75	14.6%
男女合計	11	26.8%	9	13.0%	12	11.4%	16	11.5%	25	15.0%	16	16.5%	25	28.4%	61	20.3%	175	17.4%
2と回答																		
男性	9	42.9%	8	25.0%	7	13.7%	16	24.2%	7	8.0%	13	27.7%	8	18.2%	34	23.8%	102	20.7%
女性	5	25.0%	4	10.8%	9	16.7%	10	13.7%	17	21.5%	7	14.0%	14	31.8%	38	24.1%	104	20.2%
男女合計	14	34.1%	12	17.4%	16	15.2%	26	18.7%	24	14.4%	20	20.6%	22	25.0%	72	23.9%	206	20.5%
3と回答																		
男性	5	23.8%	9	28.1%	14	27.5%	12	18.2%	18	20.5%	8	17.0%	8	18.2%	26	18.2%	100	20.3%
女性	6	30.0%	7	18.9%	7	13.0%	9	12.3%	12	15.2%	11	22.0%	7	15.9%	39	24.7%	98	19.0%
男女合計	11	26.8%	16	23.2%	21	20.0%	21	15.1%	30	18.0%	19	19.6%	15	17.0%	65	21.6%	198	19.7%
4と回答																		
男性	1	4.8%	13	40.6%	22	43.1%	30	45.5%	48	54.5%	18	38.3%	14	31.8%	41	28.7%	187	38.0%
女性	4	20.0%	19	51.4%	34	63.0%	45	61.6%	37	46.8%	22	44.0%	12	27.3%	57	36.1%	230	44.7%
男女合計	5	12.2%	32	46.4%	56	53.3%	75	54.0%	85	50.9%	40	41.2%	26	29.5%	98	32.6%	417	41.4%
無回答																		
男性	0	0.0%	0	0.0%	0	0.0%	0	0.0%	2	2.3%	0	0.0%	0	0.0%	1	0.7%	3	0.6%
女性	0	0.0%	0	0.0%	0	0.0%	1	1.4%	1	1.3%	2	4.0%	0	0.0%	4	2.5%	8	1.6%
男女合計	0	0.0%	0	0.0%	0	0.0%	1	0.7%	3	1.8%	2	2.1%	0	0.0%	5	1.7%	11	1.1%
全体(人)																		
男性	21		32		51		66		88		47		44		143		492	
女性	20		37		54		73		79		50		44		158		515	
男女合計	41		69		105		139		167		97		88		301		1007	

県 南

	10	割合	20	割合	30	割合	40	割合	50	割合	64	割合	69	割合	70～	割合	全体数	割合
1と回答																		
男性	8	66.7%	2	28.6%	3	15.0%	3	14.3%	7	20.6%	8	38.1%	3	14.3%	21	26.6%	55	25.6%
女性	2	20.0%	0	0.0%	3	20.0%	3	10.7%	7	20.0%	5	19.2%	5	20.8%	27	27.8%	52	21.1%
男女合計	10	45.5%	2	11.1%	6	17.1%	6	12.2%	14	20.3%	13	27.7%	8	17.8%	48	27.3%	107	23.2%
2と回答																		
男性	0	0.0%	1	14.3%	1	5.0%	3	14.3%	2	5.9%	6	28.6%	7	33.3%	17	21.5%	37	17.2%
女性	4	40.0%	2	18.2%	1	6.7%	3	10.7%	4	11.4%	8	30.8%	11	45.8%	21	21.6%	54	22.0%
男女合計	4	18.2%	3	16.7%	2	5.7%	6	12.2%	6	8.7%	14	29.8%	18	40.0%	38	21.6%	91	19.7%
3と回答																		
男性	1	8.3%	2	28.6%	4	20.0%	4	19.0%	5	14.7%	2	9.5%	2	9.5%	18	22.8%	38	17.7%
女性	0	0.0%	3	27.3%	3	20.0%	5	17.9%	7	20.0%	2	7.7%	3	12.5%	21	21.6%	44	17.9%
男女合計	1	4.5%	5	27.8%	7	20.0%	9	18.4%	12	17.4%	4	8.5%	5	11.1%	39	22.2%	82	17.8%
4と回答																		
男性	3	25.0%	2	28.6%	12	60.0%	11	52.4%	20	58.8%	5	23.8%	9	42.9%	20	25.3%	82	38.1%
女性	4	40.0%	6	54.5%	8	53.3%	17	60.7%	17	48.6%	11	42.3%	5	20.8%	22	22.7%	90	36.6%
男女合計	7	31.8%	8	44.4%	20	57.1%	28	57.1%	37	53.6%	16	34.0%	14	31.1%	42	23.9%	172	37.3%
無回答																		
男性	0	0.0%	0	0.0%	0	0.0%	0	0.0%	0	0.0%	0	0.0%	0	0.0%	3	3.8%	3	1.4%
女性	0	0.0%	0	0.0%	0	0.0%	0	0.0%	0	0.0%	0	0.0%	0	0.0%	6	6.2%	6	2.4%
男女合計	0	0.0%	0	0.0%	0	0.0%	0	0.0%	0	0.0%	0	0.0%	0	0.0%	9	5.1%	9	2.0%
全体(人)																		
男性	12		7		20		21		34		21		21		79		215	
女性	10		11		15		28		35		26		24		97		246	
男女合計	22		18		35		49		69		47		45		176		461	

会 津

	10	割合	20	割合	30	割合	40	割合	50	割合	64	割合	69	割合	70～	割合	全体数	割合
1と回答																		
男性	2	33.3%	4	22.2%	1	3.6%	6	14.0%	3	9.4%	6	27.3%	8	32.0%	29	29.3%	59	21.6%
女性	1	14.3%	3	27.3%	1	4.0%	3	7.9%	6	14.3%	9	32.1%	4	12.5%	22	18.8%	49	16.3%
男女合計	3	23.1%	7	24.1%	2	3.8%	9	11.1%	9	12.2%	15	30.0%	12	21.1%	51	23.6%	108	18.8%
2と回答																		
男性	1	16.7%	3	16.7%	9	32.1%	10	23.3%	8	25.0%	3	13.6%	5	20.0%	21	21.2%	60	22.0%
女性	2	28.6%	5	45.5%	3	12.0%	7	18.4%	8	19.0%	8	28.6%	6	18.8%	31	26.5%	70	23.3%
男女合計	3	23.1%	8	27.6%	12	22.6%	17	21.0%	16	21.6%	11	22.0%	11	19.3%	52	24.1%	130	22.7%
3と回答																		
男性	2	33.3%	6	33.3%	5	17.9%	11	25.6%	4	12.5%	1	4.5%	7	28.0%	17	17.2%	53	19.4%
女性	1	14.3%	1	9.1%	5	20.0%	7	18.4%	6	14.3%	2	7.1%	8	25.0%	18	15.4%	48	16.0%
男女合計	3	23.1%	7	24.1%	10	18.9%	18	22.2%	10	13.5%	3	6.0%	15	26.3%	35	16.2%	101	17.6%
4と回答																		
男性	1	16.7%	5	27.8%	13	46.4%	16	37.2%	16	50.0%	12	54.5%	5	20.0%	30	30.3%	98	35.9%
女性	3	42.9%	2	18.2%	16	64.0%	21	55.3%	22	52.4%	9	32.1%	12	37.5%	41	35.0%	126	42.0%
男女合計	4	30.8%	7	24.1%	29	54.7%	37	45.7%	38	51.4%	21	42.0%	17	29.8%	71	32.9%	224	39.1%
無回答																		
男性	0	0.0%	0	0.0%	0	0.0%	0	0.0%	1	3.1%	0	0.0%	0	0.0%	2	2.0%	3	1.1%
女性	0	0.0%	0	0.0%	0	0.0%	0	0.0%	0	0.0%	0	0.0%	2	6.3%	5	4.3%	7	2.3%
男女合計	0	0.0%	0	0.0%	0	0.0%	0	0.0%	1	1.4%	0	0.0%	2	3.5%	7	3.2%	10	1.7%
全体(人)																		
男性	6		18		28		43		32		22		25		99		273	
女性	7		11		25		38		42		28		32		117		300	
男女合計	13		29		53		81		74		50		57		216		573	

南 会 津

	10	割合	20	割合	30	割合	40	割合	50	割合	64	割合	69	割合	70～	割合	全体数	割合
1と回答																		
男性	0	0.0%	1	33.3%	1	50.0%	1	33.3%	2	66.7%	0	0.0%	1	25.0%	1	7.1%	7	23.3%
女性	0	0.0%	0	0.0%	1	50.0%	0	0.0%	1	100.0%	1	33.3%	1	25.0%	4	30.8%	8	30.8%
男女合計	0	0.0%	1	33.3%	2	50.0%	1	16.7%	3	75.0%	1	25.0%	2	25.0%	5	18.5%	15	26.8%
2と回答																		
男性	0	0.0%	1	33.3%	1	50.0%	0	0.0%	0	0.0%	0	0.0%	0	0.0%	4	28.6%	6	20.0%
女性	0	0.0%	0	0.0%	0	0.0%	0	0.0%	0	0.0%	0	0.0%	0	0.0%	2	15.4%	2	7.7%
男女合計	0	0.0%	1	33.3%	1	25.0%	0	0.0%	0	0.0%	0	0.0%	0	0.0%	6	22.2%	8	14.3%
3と回答																		
男性	0	0.0%	0	0.0%	0	0.0%	0	0.0%	1	33.3%	0	0.0%	1	25.0%	3	21.4%	5	16.7%
女性	0	0.0%	0	0.0%	0	0.0%	1	33.3%	0	0.0%	2	66.7%	1	25.0%	0	0.0%	4	15.4%
男女合計	0	0.0%	0	0.0%	0	0.0%	1	16.7%	1	25.0%	2	50.0%	2	25.0%	3	11.1%	9	16.1%
4と回答																		
男性	0	0.0%	1	33.3%	0	0.0%	2	66.7%	0	0.0%	1	100.0%	2	50.0%	6	42.9%	12	40.0%
女性	0	0.0%	0	0.0%	1	50.0%	2	66.7%	0	0.0%	0	0.0%	2	50.0%	6	46.2%	11	42.3%
男女合計	0	0.0%	1	33.3%	1	25.0%	4	66.7%	0	0.0%	1	25.0%	4	50.0%	12	44.4%	23	41.1%
無回答																		
男性	0	0.0%	0	0.0%	0	0.0%	0	0.0%	0	0.0%	0	0.0%	0	0.0%	0	0.0%	0	0.0%
女性	0	0.0%	0	0.0%	0	0.0%	0	0.0%	0	0.0%	0	0.0%	0	0.0%	1	7.7%	1	3.8%
男女合計	0	0.0%	0	0.0%	0	0.0%	0	0.0%	0	0.0%	0	0.0%	0	0.0%	1	3.7%	1	1.8%
全体(人)																		
男性	0		3		2		3		3		1		4		14		30	
女性	0		0		2		3		1		3		4		13		26	
男女合計	0		3		4		6		4		4		8		27		56	

相 双

	10	割合	20	割合	30	割合	40	割合	50	割合	64	割合	69	割合	70～	割合	全体数	割合
1と回答																		
男性	3	50.0%	1	16.7%	2	16.7%	3	16.7%	3	15.0%	2	14.3%	3	15.0%	16	28.1%	33	21.6%
女性	4	66.7%	0	0.0%	0	0.0%	0	0.0%	3	15.0%	2	18.2%	3	15.8%	18	30.0%	30	19.0%
男女合計	7	58.3%	1	10.0%	2	7.7%	3	7.1%	6	15.0%	4	16.0%	6	15.4%	34	29.1%	63	20.3%
2と回答																		
男性	2	33.3%	1	16.7%	5	41.7%	2	11.1%	4	20.0%	2	14.3%	6	30.0%	18	31.6%	40	26.1%
女性	0	0.0%	1	25.0%	1	7.1%	5	20.8%	5	25.0%	1	9.1%	8	42.1%	17	28.3%	38	24.1%
男女合計	2	16.7%	2	20.0%	6	23.1%	7	16.7%	9	22.5%	3	12.0%	14	35.9%	35	29.9%	78	25.1%
3と回答																		
男性	1	16.7%	0	0.0%	1	8.3%	5	27.8%	4	20.0%	3	21.4%	3	15.0%	8	14.0%	25	16.3%
女性	1	16.7%	0	0.0%	4	28.6%	6	25.0%	6	30.0%	2	18.2%	2	10.5%	11	18.3%	32	20.3%
男女合計	2	16.7%	0	0.0%	5	19.2%	11	26.2%	10	25.0%	5	20.0%	5	12.8%	19	16.2%	57	18.3%
4と回答																		
男性	0	0.0%	4	66.7%	4	33.3%	8	44.4%	9	45.0%	7	50.0%	8	40.0%	14	24.6%	54	35.3%
女性	1	16.7%	3	75.0%	9	64.3%	13	54.2%	6	30.0%	6	54.5%	6	31.6%	13	21.7%	57	36.1%
男女合計	1	8.3%	7	70.0%	13	50.0%	21	50.0%	15	37.5%	13	52.0%	14	35.9%	27	23.1%	111	35.7%
無回答																		
男性	0	0.0%	0	0.0%	0	0.0%	0	0.0%	0	0.0%	0	0.0%	0	0.0%	1	1.8%	1	0.7%
女性	0	0.0%	0	0.0%	0	0.0%	0	0.0%	0	0.0%	0	0.0%	0	0.0%	1	1.7%	1	0.6%
男女合計	0	0.0%	0	0.0%	0	0.0%	0	0.0%	0	0.0%	0	0.0%	0	0.0%	2	1.7%	2	0.6%
全体(人)																		
男性	6		6		12		18		20		14		20		57		153	
女性	6		4		14		24		20		11		19		60		158	
男女合計	12		10		26		42		40		25		39		117		311	

いわき

	10	割合	20	割合	30	割合	40	割合	50	割合	64	割合	69	割合	70～	割合	全体数	割合
1と回答																		
男性	5	38.5%	4	40.0%	5	14.3%	3	10.0%	9	18.8%	6	14.3%	7	15.6%	38	29.5%	77	21.9%
女性	1	6.3%	2	11.8%	2	7.1%	2	6.9%	11	17.5%	6	13.0%	7	16.3%	37	26.2%	68	17.8%
男女合計	6	20.7%	6	22.2%	7	11.1%	5	8.5%	20	18.0%	12	13.6%	14	15.9%	75	27.8%	145	19.7%
2と回答																		
男性	3	23.1%	1	10.0%	7	20.0%	4	13.3%	8	16.7%	12	28.6%	15	33.3%	29	22.5%	79	22.4%
女性	6	37.5%	3	17.6%	6	21.4%	8	27.6%	13	20.6%	8	17.4%	14	32.6%	42	29.8%	100	26.1%
男女合計	9	31.0%	4	14.8%	13	20.6%	12	20.3%	21	18.9%	20	22.7%	29	33.0%	71	26.3%	179	24.4%
3と回答																		
男性	3	23.1%	1	10.0%	10	28.6%	3	10.0%	9	18.8%	11	26.2%	6	13.3%	25	19.4%	68	19.3%
女性	4	25.0%	3	17.6%	5	17.9%	4	13.8%	9	14.3%	9	19.6%	8	18.6%	21	14.9%	63	16.4%
男女合計	7	24.1%	4	14.8%	15	23.8%	7	11.9%	18	16.2%	20	22.7%	14	15.9%	46	17.0%	131	17.8%
4と回答																		
男性	2	15.4%	4	40.0%	13	37.1%	20	66.7%	22	45.8%	12	28.6%	17	37.8%	34	26.4%	124	35.2%
女性	5	31.3%	9	52.9%	15	53.6%	15	51.7%	30	47.6%	22	47.8%	14	32.6%	38	27.0%	148	38.6%
男女合計	7	24.1%	13	48.1%	28	44.4%	35	59.3%	52	46.8%	34	38.6%	31	35.2%	72	26.7%	272	37.0%
無回答																		
男性	0	0.0%	0	0.0%	0	0.0%	0	0.0%	0	0.0%	1	2.4%	0	0.0%	3	2.3%	4	1.1%
女性	0	0.0%	0	0.0%	0	0.0%	0	0.0%	0	0.0%	1	2.2%	0	0.0%	3	2.1%	4	1.0%
男女合計	0	0.0%	0	0.0%	0	0.0%	0	0.0%	0	0.0%	2	2.3%	0	0.0%	6	2.2%	8	1.1%
全体(人)																		
男性	13		10		35		30		48		42		45		129		352	
女性	16		17		28		29		63		46		43		141		383	
男女合計	29		27		63		59		111		88		88		270		735	

全県(60歳以上・再掲)

	64	割合	69	割合	70	割合	80	割合	90	割合	全体数	割合
1と回答												
男性	38	19.4%	47	22.3%	123	28.5%	54	28.9%	7	16.3%	269	25.2%
女性	39	18.8%	42	19.0%	90	21.2%	67	24.2%	8	11.0%	246	20.4%
男女合計	77	19.1%	89	20.6%	213	24.9%	121	26.1%	15	12.9%	515	22.7%
2と回答												
男性	42	21.4%	54	25.6%	113	26.2%	42	22.5%	7	16.3%	258	24.1%
女性	45	21.6%	70	31.7%	136	32.0%	55	19.9%	8	11.0%	314	26.1%
男女合計	87	21.5%	124	28.7%	249	29.1%	97	20.9%	15	12.9%	572	25.2%
3と回答												
男性	35	17.9%	34	16.1%	76	17.6%	33	17.6%	9	20.9%	187	17.5%
女性	34	16.3%	39	17.6%	73	17.2%	55	19.9%	10	13.7%	211	17.5%
男女合計	69	17.1%	73	16.9%	149	17.4%	88	19.0%	19	16.4%	398	17.5%
4と回答												
男性	80	40.8%	76	36.0%	116	26.9%	54	28.9%	18	41.9%	344	32.2%
女性	87	41.8%	67	30.3%	115	27.1%	89	32.1%	45	61.6%	403	33.5%
男女合計	167	41.3%	143	33.1%	231	27.0%	143	30.8%	63	54.3%	747	32.9%
無回答												
男性	1	0.5%	0	0.0%	4	0.9%	4	2.1%	2	4.7%	11	1.0%
女性	3	1.4%	3	1.4%	11	2.6%	11	4.0%	2	2.7%	30	2.5%
男女合計	4	1.0%	3	0.7%	15	1.8%	15	3.2%	4	3.4%	41	1.8%
全体(人)												
男性	196		211		432		187		43		1069	
女性	208		221		425		277		73		1204	
男女合計	404		432		857		464		116		2273	

(2) 運動時間 (調査票 問10付問)

付問 問10で1～3を選んだ方におたずねします。1回の運動時間はどれくらいですか。
 複数の運動をしている方は、もっとも運動時間の長いものについてお答えください。

1 15分未満 2 15～30分未満 3 30分以上

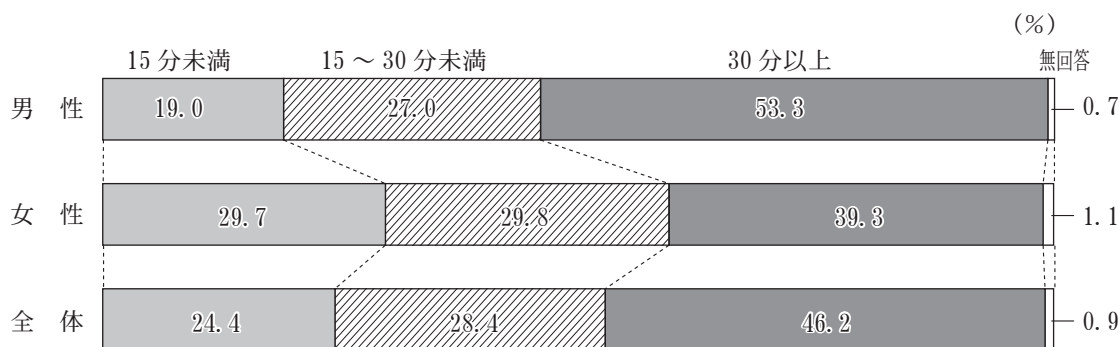

	10	割合	20	割合	30	割合	40	割合	50	割合	64	割合	69	割合	70	割合	80	割合	90	割合	全体数	割合
1と回答																						
男性	4	5.6%	9	11.3%	12	11.4%	16	14.4%	34	21.8%	24	20.9%	21	15.6%	65	20.8%	36	27.9%	14	60.9%	235	19.0%
女性	8	15.4%	24	38.7%	23	30.7%	18	16.7%	63	33.9%	45	38.1%	39	25.8%	73	24.4%	65	36.7%	15	57.7%	373	29.7%
男女合計	12	9.8%	33	23.2%	35	19.4%	34	15.5%	97	28.4%	69	29.6%	60	21.0%	138	22.6%	101	33.0%	29	59.2%	608	24.4%
2と回答																						
男性	14	19.7%	26	32.5%	32	30.5%	32	28.8%	45	28.8%	31	27.0%	45	33.3%	65	20.8%	41	31.8%	3	13.0%	334	27.0%
女性	10	19.2%	13	21.0%	23	30.7%	45	41.7%	57	30.6%	35	29.7%	43	28.5%	95	31.8%	47	26.6%	6	23.1%	374	29.8%
男女合計	24	19.5%	39	27.5%	55	30.6%	77	35.2%	102	29.8%	66	28.3%	88	30.8%	160	26.2%	88	28.8%	9	18.4%	708	28.4%
3と回答																						
男性	53	74.6%	45	56.3%	61	58.1%	63	56.8%	75	48.1%	60	52.2%	69	51.1%	179	57.4%	48	37.2%	6	26.1%	659	53.3%
女性	34	65.4%	25	40.3%	29	38.7%	43	39.8%	65	34.9%	37	31.4%	67	44.4%	128	42.8%	60	33.9%	5	19.2%	493	39.3%
男女合計	87	70.7%	70	49.3%	90	50.0%	106	48.4%	140	40.9%	97	41.6%	136	47.6%	307	50.2%	108	35.3%	11	22.4%	1152	46.2%
無回答																						
男性	0	0.0%	0	0.0%	0	0.0%	0	0.0%	2	1.3%	0	0.0%	0	0.0%	3	1.0%	4	3.1%	0	0.0%	9	0.7%
女性	0	0.0%	0	0.0%	0	0.0%	2	1.9%	1	0.5%	1	0.8%	2	1.3%	3	1.0%	5	2.8%	0	0.0%	14	1.1%
男女合計	0	0.0%	0	0.0%	0	0.0%	2	0.9%	3	0.9%	1	0.4%	2	0.7%	6	1.0%	9	2.9%	0	0.0%	23	0.9%
全体(人)																						
男性	71		80		105		111		156		115		135		312		129		23		1237	
女性	52		62		75		108		186		118		151		299		177		26		1254	
男女合計	123		142		180		219		342		233		286		611		306		49		2491	

県 北

	10	割合	20	割合	30	割合	40	割合	50	割合	64	割合	69	割合	70～	割合	全体数	割合
1と回答																		
男性	0	0.0%	4	12.1%	2	9.5%	3	17.6%	11	22.4%	5	20.8%	4	12.9%	34	34.7%	63	21.5%
女性	2	20.0%	8	38.1%	6	30.0%	5	18.5%	20	33.9%	9	33.3%	10	26.3%	32	28.3%	92	29.2%
男女合計	2	6.7%	12	22.2%	8	19.5%	8	18.2%	31	28.7%	14	27.5%	14	20.3%	66	31.3%	155	25.5%
2と回答																		
男性	4	20.0%	11	33.3%	7	33.3%	3	17.6%	9	18.4%	6	25.0%	12	38.7%	18	18.4%	70	23.9%
女性	3	30.0%	6	28.6%	6	30.0%	13	48.1%	16	27.1%	8	29.6%	7	18.4%	32	28.3%	91	28.9%
男女合計	7	23.3%	17	31.5%	13	31.7%	16	36.4%	25	23.1%	14	27.5%	19	27.5%	50	23.7%	161	26.5%
3と回答																		
男性	16	80.0%	18	54.5%	12	57.1%	11	64.7%	28	57.1%	13	54.2%	15	48.4%	45	45.9%	158	53.9%
女性	5	50.0%	7	33.3%	8	40.0%	9	33.3%	23	39.0%	10	37.0%	21	55.3%	47	41.6%	130	41.3%
男女合計	21	70.0%	25	46.3%	20	48.8%	20	45.5%	51	47.2%	23	45.1%	36	52.2%	92	43.6%	288	47.4%
無回答																		
男性	0	0.0%	0	0.0%	0	0.0%	0	0.0%	1	2.0%	0	0.0%	0	0.0%	1	1.0%	2	0.7%
女性	0	0.0%	0	0.0%	0	0.0%	0	0.0%	0	0.0%	0	0.0%	0	0.0%	2	1.8%	2	0.6%
男女合計	0	0.0%	0	0.0%	0	0.0%	0	0.0%	1	0.9%	0	0.0%	0	0.0%	3	1.4%	4	0.7%
全体(人)																		
男性	20		33		21		17		49		24		31		98		293	
女性	10		21		20		27		59		27		38		113		315	
男女合計	30		54		41		44		108		51		69		211		608	

県 中

	10	割合	20	割合	30	割合	40	割合	50	割合	64	割合	69	割合	70～	割合	全体数	割合
1と回答																		
男性	4	20.0%	3	15.8%	6	20.7%	7	19.4%	12	31.6%	6	20.7%	3	10.0%	29	28.7%	70	23.2%
女性	3	18.8%	7	38.9%	5	25.0%	5	18.5%	16	39.0%	8	30.8%	6	18.8%	36	37.1%	86	31.0%
男女合計	7	19.4%	10	27.0%	11	22.4%	12	19.0%	28	35.4%	14	25.5%	9	14.5%	65	32.8%	156	26.9%
2と回答																		
男性	4	20.0%	5	26.3%	8	27.6%	9	25.0%	11	28.9%	8	27.6%	11	36.7%	21	20.8%	77	25.5%
女性	2	12.5%	3	16.7%	7	35.0%	11	40.7%	12	29.3%	8	30.8%	11	34.4%	23	23.7%	77	27.8%
男女合計	6	16.7%	8	21.6%	15	30.6%	20	31.7%	23	29.1%	16	29.1%	22	35.5%	44	22.2%	154	26.6%
3と回答																		
男性	12	60.0%	11	57.9%	15	51.7%	20	55.6%	15	39.5%	15	51.7%	16	53.3%	49	48.5%	153	50.7%
女性	11	68.8%	8	44.4%	8	40.0%	10	37.0%	13	31.7%	9	34.6%	15	46.9%	35	36.1%	109	39.4%
男女合計	23	63.9%	19	51.4%	23	46.9%	30	47.6%	28	35.4%	24	43.6%	31	50.0%	84	42.4%	262	45.3%
無回答																		
男性	0	0.0%	0	0.0%	0	0.0%	0	0.0%	0	0.0%	0	0.0%	0	0.0%	2	2.0%	2	0.7%
女性	0	0.0%	0	0.0%	0	0.0%	1	3.7%	0	0.0%	1	3.8%	0	0.0%	3	3.1%	5	1.8%
男女合計	0	0.0%	0	0.0%	0	0.0%	1	1.6%	0	0.0%	1	1.8%	0	0.0%	5	2.5%	7	1.2%
全体(人)																		
男性	20		19		29		36		38		29		30		101		302	
女性	16		18		20		27		41		26		32		97		277	
男女合計	36		37		49		63		79		55		62		198		579	

県 南

	10	割合	20	割合	30	割合	40	割合	50	割合	64	割合	69	割合	70～	割合	全体数	割合
1と回答																		
男性	0	0.0%	1	20.0%	2	25.0%	1	10.0%	5	35.7%	2	12.5%	1	8.3%	15	26.8%	27	20.8%
女性	0	0.0%	2	40.0%	4	57.1%	2	18.2%	8	44.4%	7	46.7%	4	21.1%	25	36.2%	52	34.7%
男女合計	0	0.0%	3	30.0%	6	40.0%	3	14.3%	13	40.6%	9	29.0%	5	16.1%	40	32.0%	79	28.2%
2と回答																		
男性	2	22.2%	1	20.0%	1	12.5%	5	50.0%	5	35.7%	5	31.3%	6	50.0%	14	25.0%	39	30.0%
女性	2	33.3%	1	20.0%	1	14.3%	4	36.4%	3	16.7%	5	33.3%	6	31.6%	17	24.6%	39	26.0%
男女合計	4	26.7%	2	20.0%	2	13.3%	9	42.9%	8	25.0%	10	32.3%	12	38.7%	31	24.8%	78	27.9%
3と回答																		
男性	7	77.8%	3	60.0%	5	62.5%	4	40.0%	3	21.4%	9	56.3%	5	41.7%	26	46.4%	62	47.7%
女性	4	66.7%	2	40.0%	2	28.6%	5	45.5%	7	38.9%	3	20.0%	9	47.4%	27	39.1%	59	39.3%
男女合計	11	73.3%	5	50.0%	7	46.7%	9	42.9%	10	31.3%	12	38.7%	14	45.2%	53	42.4%	121	43.2%
無回答																		
男性	0	0.0%	0	0.0%	0	0.0%	0	0.0%	1	7.1%	0	0.0%	0	0.0%	1	1.8%	2	1.5%
女性	0	0.0%	0	0.0%	0	0.0%	0	0.0%	0	0.0%	0	0.0%	0	0.0%	0	0.0%	0	0.0%
男女合計	0	0.0%	0	0.0%	0	0.0%	0	0.0%	1	3.1%	0	0.0%	0	0.0%	1	0.8%	2	0.7%
全体(人)																		
男性	9		5		8		10		14		16		12		56		130	
女性	6		5		7		11		18		15		19		69		150	
男女合計	15		10		15		21		32		31		31		125		280	

会 津

	10	割合	20	割合	30	割合	40	割合	50	割合	64	割合	69	割合	70～	割合	全体数	割合
1と回答																		
男性	0	0.0%	0	0.0%	0	0.0%	4	14.8%	2	13.3%	2	20.0%	6	30.0%	21	31.3%	35	20.3%
女性	0	0.0%	4	44.4%	1	11.1%	4	23.5%	5	25.0%	8	42.1%	7	38.9%	19	26.8%	48	28.7%
男女合計	0	0.0%	4	18.2%	1	4.2%	8	18.2%	7	20.0%	10	34.5%	13	34.2%	40	29.0%	83	24.5%
2と回答																		
男性	0	0.0%	5	38.5%	6	40.0%	10	37.0%	4	26.7%	2	20.0%	2	10.0%	16	23.9%	45	26.2%
女性	1	25.0%	1	11.1%	4	44.4%	5	29.4%	9	45.0%	4	21.1%	2	11.1%	24	33.8%	50	29.9%
男女合計	1	11.1%	6	27.3%	10	41.7%	15	34.1%	13	37.1%	6	20.7%	4	10.5%	40	29.0%	95	28.0%
3と回答																		
男性	5	100.0%	8	61.5%	9	60.0%	13	48.1%	9	60.0%	6	60.0%	12	60.0%	30	44.8%	92	53.5%
女性	3	75.0%	4	44.4%	4	44.4%	8	47.1%	5	25.0%	7	36.8%	7	38.9%	27	38.0%	65	38.9%
男女合計	8	88.9%	12	54.5%	13	54.2%	21	47.7%	14	40.0%	13	44.8%	19	50.0%	57	41.3%	157	46.3%
無回答																		
男性	0	0.0%	0	0.0%	0	0.0%	0	0.0%	0	0.0%	0	0.0%	0	0.0%	0	0.0%	0	0.0%
女性	0	0.0%	0	0.0%	0	0.0%	0	0.0%	1	5.0%	0	0.0%	2	11.1%	1	1.4%	4	2.4%
男女合計	0	0.0%	0	0.0%	0	0.0%	0	0.0%	1	2.9%	0	0.0%	2	5.3%	1	0.7%	4	1.2%
全体(人)																		
男性	5		13		15		27		15		10		20		67		172	
女性	4		9		9		17		20		19		18		71		167	
男女合計	9		22		24		44		35		29		38		138		339	

南 会 津

	10	割合	20	割合	30	割合	40	割合	50	割合	64	割合	69	割合	70～	割合	全体数	割合
1と回答																		
男性	0	0.0%	0	0.0%	0	0.0%	0	0.0%	0	0.0%	0	0.0%	1	50.0%	2	25.0%	3	16.7%
女性	0	0.0%	0	0.0%	1	100.0%	0	0.0%	0	0.0%	2	66.7%	1	50.0%	2	33.3%	6	42.9%
男女合計	0	0.0%	0	0.0%	1	33.3%	0	0.0%	0	0.0%	2	66.7%	2	50.0%	4	28.6%	9	28.1%
2と回答																		
男性	0	0.0%	1	50.0%	1	50.0%	0	0.0%	1	33.3%	0	0.0%	0	0.0%	2	25.0%	5	27.8%
女性	0	0.0%	0	0.0%	0	0.0%	1	100.0%	1	100.0%	0	0.0%	0	0.0%	4	66.7%	6	42.9%
男女合計	0	0.0%	1	50.0%	1	33.3%	1	50.0%	2	50.0%	0	0.0%	0	0.0%	6	42.9%	11	34.4%
3と回答																		
男性	0	0.0%	1	50.0%	1	50.0%	1	100.0%	2	66.7%	0	0.0%	1	50.0%	3	37.5%	9	50.0%
女性	0	0.0%	0	0.0%	0	0.0%	0	0.0%	0	0.0%	1	33.3%	1	50.0%	0	0.0%	2	14.3%
男女合計	0	0.0%	1	50.0%	1	33.3%	1	50.0%	2	50.0%	1	33.3%	2	50.0%	3	21.4%	11	34.4%
無回答																		
男性	0	0.0%	0	0.0%	0	0.0%	0	0.0%	0	0.0%	0	0.0%	0	0.0%	1	12.5%	1	5.6%
女性	0	0.0%	0	0.0%	0	0.0%	0	0.0%	0	0.0%	0	0.0%	0	0.0%	0	0.0%	0	0.0%
男女合計	0	0.0%	0	0.0%	0	0.0%	0	0.0%	0	0.0%	0	0.0%	0	0.0%	1	7.1%	1	3.1%
全体(人)																		
男性	0		2		2		1		3		0		2		8		18	
女性	0		0		1		1		1		3		2		6		14	
男女合計	0		2		3		2		4		3		4		14		32	

相 双

	10	割合	20	割合	30	割合	40	割合	50	割合	64	割合	69	割合	70～	割合	全体数	割合
1と回答																		
男性	0	0.0%	0	0.0%	0	0.0%	0	0.0%	2	18.2%	1	14.3%	1	8.3%	6	14.3%	10	10.2%
女性	0	0.0%	0	0.0%	1	20.0%	2	18.2%	5	35.7%	3	60.0%	3	23.1%	16	34.8%	30	30.0%
男女合計	0	0.0%	0	0.0%	1	7.7%	2	9.5%	7	28.0%	4	33.3%	4	16.0%	22	25.0%	40	20.2%
2と回答																		
男性	1	16.7%	1	50.0%	3	37.5%	3	30.0%	4	36.4%	1	14.3%	4	33.3%	12	28.6%	29	29.6%
女性	0	0.0%	1	100.0%	1	20.0%	5	45.5%	4	28.6%	2	40.0%	7	53.8%	15	32.6%	35	35.0%
男女合計	1	9.1%	2	66.7%	4	30.8%	8	38.1%	8	32.0%	3	25.0%	11	44.0%	27	30.7%	64	32.3%
3と回答																		
男性	5	83.3%	1	50.0%	5	62.5%	7	70.0%	5	45.5%	5	71.4%	7	58.3%	23	54.8%	58	59.2%
女性	5	100.0%	0	0.0%	3	60.0%	4	36.4%	5	35.7%	0	0.0%	3	23.1%	15	32.6%	35	35.0%
男女合計	10	90.9%	1	33.3%	8	61.5%	11	52.4%	10	40.0%	5	41.7%	10	40.0%	38	43.2%	93	47.0%
無回答																		
男性	0	0.0%	0	0.0%	0	0.0%	0	0.0%	0	0.0%	0	0.0%	0	0.0%	1	2.4%	1	1.0%
女性	0	0.0%	0	0.0%	0	0.0%	0	0.0%	0	0.0%	0	0.0%	0	0.0%	0	0.0%	0	0.0%
男女合計	0	0.0%	0	0.0%	0	0.0%	0	0.0%	0	0.0%	0	0.0%	0	0.0%	1	1.1%	1	0.5%
全体(人)																		
男性	6		2		8		10		11		7		12		42		98	
女性	5		1		5		11		14		5		13		46		100	
男女合計	11		3		13		21		25		12		25		88		198	

いわき

	10	割合	20	割合	30	割合	40	割合	50	割合	64	割合	69	割合	70～	割合	全体数	割合
1と回答																		
男性	0	0.0%	1	16.7%	2	9.1%	1	10.0%	2	7.7%	8	27.6%	5	17.9%	8	8.7%	27	12.1%
女性	3	27.3%	3	37.5%	5	38.5%	0	0.0%	9	27.3%	8	34.8%	8	27.6%	23	23.0%	59	25.5%
男女合計	3	13.6%	4	28.6%	7	20.0%	1	4.2%	11	18.6%	16	30.8%	13	22.8%	31	16.1%	86	18.9%
2と回答																		
男性	3	27.3%	2	33.3%	6	27.3%	2	20.0%	11	42.3%	9	31.0%	10	35.7%	26	28.3%	69	30.8%
女性	2	18.2%	1	12.5%	4	30.8%	6	42.9%	12	36.4%	8	34.8%	10	34.5%	33	33.0%	76	32.9%
男女合計	5	22.7%	3	21.4%	10	28.6%	8	33.3%	23	39.0%	17	32.7%	20	35.1%	59	30.7%	145	31.9%
3と回答																		
男性	8	72.7%	3	50.0%	14	63.6%	7	70.0%	13	50.0%	12	41.4%	13	46.4%	57	62.0%	127	56.7%
女性	6	54.5%	4	50.0%	4	30.8%	7	50.0%	12	36.4%	7	30.4%	11	37.9%	42	42.0%	93	40.3%
男女合計	14	63.6%	7	50.0%	18	51.4%	14	58.3%	25	42.4%	19	36.5%	24	42.1%	99	51.6%	220	48.4%
無回答																		
男性	0	0.0%	0	0.0%	0	0.0%	0	0.0%	0	0.0%	0	0.0%	0	0.0%	1	1.1%	1	0.4%
女性	0	0.0%	0	0.0%	0	0.0%	1	7.1%	0	0.0%	0	0.0%	0	0.0%	2	2.0%	3	1.3%
男女合計	0	0.0%	0	0.0%	0	0.0%	1	4.2%	0	0.0%	0	0.0%	0	0.0%	3	1.6%	4	0.9%
全体(人)																		
男性	11		6		22		10		26		29		28		92		224	
女性	11		8		13		14		33		23		29		100		231	
男女合計	22		14		35		24		59		52		57		192		455	

全県(60歳以上・再掲)

	64	割合	69	割合	70	割合	80	割合	90	割合	全体数	割合
1と回答												
男性	24	20.9%	21	15.6%	65	20.8%	36	27.9%	14	60.9%	160	22.4%
女性	45	38.1%	39	25.8%	73	24.4%	65	36.7%	15	57.7%	237	30.7%
男女合計	69	29.6%	60	21.0%	138	22.6%	101	33.0%	29	59.2%	397	26.7%
2と回答												
男性	31	27.0%	45	33.3%	65	20.8%	41	31.8%	3	13.0%	185	25.9%
女性	35	29.7%	43	28.5%	95	31.8%	47	26.6%	6	23.1%	226	29.3%
男女合計	66	28.3%	88	30.8%	160	26.2%	88	28.8%	9	18.4%	411	27.7%
3と回答												
男性	60	52.2%	69	51.1%	179	57.4%	48	37.2%	6	26.1%	362	50.7%
女性	37	31.4%	67	44.4%	128	42.8%	60	33.9%	5	19.2%	297	38.5%
男女合計	97	41.6%	136	47.6%	307	50.2%	108	35.3%	11	22.4%	659	44.4%
無回答												
男性	0	0.0%	0	0.0%	3	1.0%	4	3.1%	0	0.0%	7	1.0%
女性	1	0.8%	2	1.3%	3	1.0%	5	2.8%	0	0.0%	11	1.4%
男女合計	1	0.4%	2	0.7%	6	1.0%	9	2.9%	0	0.0%	18	1.2%
全体(人)												
男性	115		135		312		129		23		714	
女性	118		151		299		177		26		771	
男女合計	233		286		611		306		49		1485	

(3) 運動習慣の状況 (満20歳以上対象)

(「(1) 運動の状況」及び「(2) 運動時間」の回答に関するクロス集計)

	20	割合	30	割合	40	割合	50	割合	64	割合	69	割合	70	割合	80	割合	90	割合	全体数	割合
何らかの運動をほとんど毎日、15分未満している。																				
男性	2	1.6%	3	1.6%	5	2.1%	9	2.9%	10	5.1%	7	3.3%	30	6.9%	13	7.0%	5	11.6%	84	4.3%
女性	5	4.0%	5	2.7%	2	0.8%	25	7.2%	17	8.2%	14	6.3%	22	5.2%	25	9.0%	4	5.5%	119	5.6%
男女合計	7	2.8%	8	2.1%	7	1.4%	34	5.2%	27	6.7%	21	4.9%	52	6.1%	38	8.2%	9	7.8%	203	5.0%
何らかの運動をほとんど毎日、15～30分未満している。																				
男性	8	6.5%	8	4.2%	7	2.9%	14	4.5%	10	5.1%	14	6.6%	20	4.6%	17	9.1%	0	0.0%	98	5.1%
女性	3	2.4%	3	1.6%	7	2.7%	14	4.0%	9	4.3%	12	5.4%	30	7.1%	17	6.1%	3	4.1%	98	4.6%
男女合計	11	4.4%	11	2.9%	14	2.8%	28	4.3%	19	4.7%	26	6.0%	50	5.8%	34	7.3%	3	2.6%	196	4.8%
何らかの運動をほとんど毎日、30分以上している。																				
男性	13	10.6%	18	9.4%	16	6.7%	21	6.7%	18	9.2%	26	12.3%	72	16.7%	23	12.3%	2	4.7%	209	10.8%
女性	8	6.4%	7	3.8%	9	3.4%	22	6.4%	13	6.3%	16	7.2%	38	8.9%	22	7.9%	1	1.4%	136	6.4%
男女合計	21	8.5%	25	6.7%	25	5.0%	43	6.5%	31	7.7%	42	9.7%	110	12.8%	45	9.7%	3	2.6%	345	8.5%
何らかの運動をほとんど毎日している。(時間無回答)																				
男性	0	0.0%	0	0.0%	0	0.0%	1	0.3%	0	0.0%	0	0.0%	1	0.2%	1	0.5%	0	0.0%	3	0.2%
女性	0	0.0%	0	0.0%	0	0.0%	1	0.3%	0	0.0%	0	0.0%	0	0.0%	3	1.1%	0	0.0%	4	0.2%
男女合計	0	0.0%	0	0.0%	0	0.0%	2	0.3%	0	0.0%	0	0.0%	1	0.1%	4	0.9%	0	0.0%	7	0.2%
何らかの運動を週2～4回程度、15分未満している。																				
男性	2	1.6%	3	1.6%	5	2.1%	4	1.3%	5	2.6%	8	3.8%	16	3.7%	8	4.3%	3	7.0%	54	2.8%
女性	6	4.8%	8	4.4%	7	2.7%	15	4.3%	13	6.3%	11	5.0%	27	6.4%	18	6.5%	5	6.8%	110	5.2%
男女合計	8	3.2%	11	2.9%	12	2.4%	19	2.9%	18	4.5%	19	4.4%	43	5.0%	26	5.6%	8	6.9%	164	4.0%
何らかの運動を週2～4回程度、15～30分未満している。																				
男性	5	4.1%	9	4.7%	13	5.5%	17	5.4%	12	6.1%	21	10.0%	21	4.9%	18	9.6%	2	4.7%	118	6.1%
女性	6	4.8%	14	7.7%	21	8.0%	22	6.4%	17	8.2%	25	11.3%	46	10.8%	16	5.8%	1	1.4%	168	7.9%
男女合計	11	4.4%	23	6.1%	34	6.8%	39	5.9%	29	7.2%	46	10.6%	67	7.8%	34	7.3%	3	2.6%	286	7.1%
何らかの運動を週2～4回程度、30分以上している。																				
男性	22	17.9%	26	13.5%	25	10.5%	25	8.0%	25	12.8%	25	11.8%	75	17.4%	13	7.0%	2	4.7%	238	12.3%
女性	10	8.0%	6	3.3%	16	6.1%	21	6.1%	15	7.2%	34	15.4%	61	14.4%	21	7.6%	2	2.7%	186	8.8%
男女合計	32	12.9%	32	8.5%	41	8.2%	46	7.0%	40	9.9%	59	13.7%	136	15.9%	34	7.3%	4	3.4%	424	10.5%
何らかの運動を週2～4回程度している。(時間無回答)																				
男性	0	0.0%	0	0.0%	0	0.0%	1	0.3%	0	0.0%	0	0.0%	1	0.2%	3	1.6%	0	0.0%	5	0.3%
女性	0	0.0%	0	0.0%	0	0.0%	0	0.0%	0	0.0%	0	0.0%	2	0.5%	0	0.0%	0	0.0%	2	0.1%
男女合計	0	0.0%	0	0.0%	0	0.0%	1	0.2%	0	0.0%	0	0.0%	3	0.4%	3	0.6%	0	0.0%	7	0.2%
何らかの運動を週1回程度、15分未満している。																				
男性	5	4.1%	6	3.1%	6	2.5%	21	6.7%	9	4.6%	6	2.8%	19	4.4%	15	8.0%	6	14.0%	93	4.8%
女性	13	10.4%	10	5.5%	9	3.4%	23	6.6%	15	7.2%	14	6.3%	24	5.6%	22	7.9%	6	8.2%	136	6.4%
男女合計	18	7.3%	16	4.3%	15	3.0%	44	6.7%	24	5.9%	20	4.6%	43	5.0%	37	8.0%	12	10.3%	229	5.6%
何らかの運動を週1回程度、15～30分未満している。																				
男性	13	10.6%	15	7.8%	12	5.0%	14	4.5%	9	4.6%	10	4.7%	24	5.6%	6	3.2%	1	2.3%	104	5.4%
女性	4	3.2%	6	3.3%	17	6.4%	21	6.1%	9	4.3%	6	2.7%	19	4.5%	14	5.1%	2	2.7%	98	4.6%
男女合計	17	6.9%	21	5.6%	29	5.8%	35	5.3%	18	4.5%	16	3.7%	43	5.0%	20	4.3%	3	2.6%	202	5.0%
何らかの運動を週1回程度、30分以上している。																				
男性	10	8.1%	17	8.9%	22	9.2%	29	9.3%	17	8.7%	18	8.5%	32	7.4%	12	6.4%	2	4.7%	159	8.2%
女性	7	5.6%	16	8.7%	18	6.8%	22	6.4%	9	4.3%	17	7.7%	29	6.8%	17	6.1%	2	2.7%	137	6.5%
男女合計	17	6.9%	33	8.8%	40	8.0%	51	7.8%	26	6.4%	35	8.1%	61	7.1%	29	6.3%	4	3.4%	296	7.3%
何らかの運動を週1回程度している。(時間無回答)																				
男性	0	0.0%	0	0.0%	0	0.0%	0	0.0%	0	0.0%	0	0.0%	1	0.2%	0	0.0%	0	0.0%	1	0.1%
女性	0	0.0%	0	0.0%	2	0.8%	0	0.0%	1	0.5%	2	0.9%	1	0.2%	2	0.7%	0	0.0%	8	0.4%
男女合計	0	0.0%	0	0.0%	2	0.4%	0	0.0%	1	0.2%	2	0.5%	2	0.2%	2	0.4%	0	0.0%	9	0.2%
ほとんど(まったく)していない。																				
男性	43	35.0%	87	45.3%	126	52.9%	152	48.7%	80	40.8%	76	36.0%	116	26.9%	54	28.9%	18	41.9%	752	38.9%
女性	62	49.6%	108	59.0%	155	58.7%	159	46.0%	87	41.8%	67	30.3%	115	27.1%	89	32.1%	45	61.6%	887	41.8%
男女合計	105	42.3%	195	52.0%	281	56.0%	311	47.3%	167	41.3%	143	33.1%	231	27.0%	143	30.8%	63	54.3%	1639	40.4%
無回答																				
男性	0	0.0%	0	0.0%	1	0.4%	4	1.3%	1	0.5%	0	0.0%	4	0.9%	4	2.1%	2	4.7%	16	0.8%
女性	1	0.8%	0	0.0%	1	0.4%	1	0.3%	3	1.4%	3	1.4%	11	2.6%	11	4.0%	2	2.7%	33	1.6%
男女合計	1	0.4%	0	0.0%	2	0.4%	5	0.8%	4	1.0%	3	0.7%	15	1.8%	15	3.2%	4	3.4%	49	1.2%
全体(人)																				
男性	123		192		238		312		196		211		432		187		43		1934	
女性	125		183		264		346		208		221		425		277		73		2122	
男女合計	248		375		502		658		404		432		857		464		116		4056	

11 喫煙の状況

(1) 喫煙の有無 (満20歳以上対象) (調査票 問11)

問11 あなたは、たばこを吸っていますか。(あてはまる番号1つに○)

- 1 毎日吸う
- 2 時々吸う
- 3 今は吸っていない
- 4 習慣的に吸ったことがない

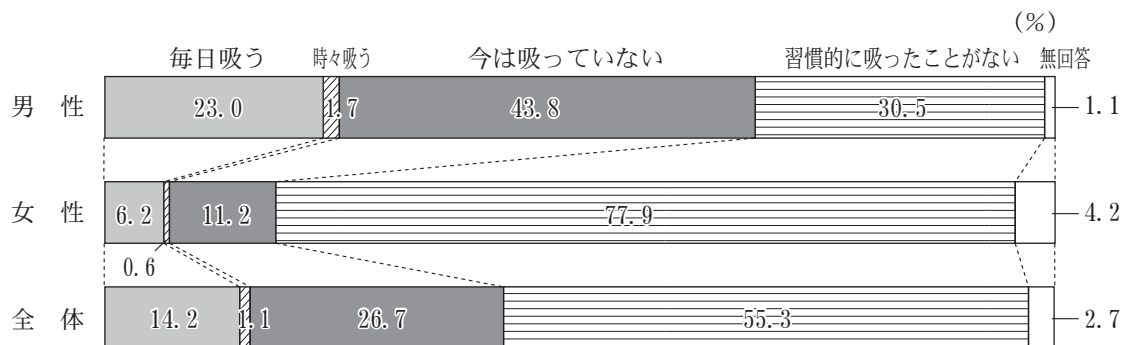

	20	割合	30	割合	40	割合	50	割合	64	割合	69	割合	70	割合	80	割合	90	割合	全体数	割合
1と回答																				
男性	16	13.0%	54	28.1%	78	32.8%	105	33.7%	61	31.1%	52	24.6%	69	16.0%	7	3.7%	2	4.7%	444	23.0%
女性	8	6.4%	16	8.7%	32	12.1%	32	9.2%	10	4.8%	12	5.4%	18	4.2%	2	0.7%	1	1.4%	131	6.2%
男女合計	24	9.7%	70	18.7%	110	21.9%	137	20.8%	71	17.6%	64	14.8%	87	10.2%	9	1.9%	3	2.6%	575	14.2%
2と回答																				
男性	7	5.7%	4	2.1%	6	2.5%	10	3.2%	1	0.5%	0	0.0%	4	0.9%	0	0.0%	0	0.0%	32	1.7%
女性	1	0.8%	4	2.2%	3	1.1%	2	0.6%	0	0.0%	0	0.0%	0	0.0%	2	0.7%	0	0.0%	12	0.6%
男女合計	8	3.2%	8	2.1%	9	1.8%	12	1.8%	1	0.2%	0	0.0%	4	0.5%	2	0.4%	0	0.0%	44	1.1%
3と回答																				
男性	10	8.1%	40	20.8%	77	32.4%	117	37.5%	83	42.3%	118	55.9%	261	60.4%	114	61.0%	27	62.8%	847	43.8%
女性	4	3.2%	25	13.7%	43	16.3%	38	11.0%	38	18.3%	27	12.2%	43	10.1%	16	5.8%	3	4.1%	237	11.2%
男女合計	14	5.6%	65	17.3%	120	23.9%	155	23.6%	121	30.0%	145	33.6%	304	35.5%	130	28.0%	30	25.9%	1084	26.7%
4と回答																				
男性	90	73.2%	94	49.0%	77	32.4%	78	25.0%	50	25.5%	38	18.0%	90	20.8%	61	32.6%	12	27.9%	590	30.5%
女性	109	87.2%	137	74.9%	183	69.3%	264	76.3%	157	75.5%	176	79.6%	336	79.1%	225	81.2%	66	90.4%	1653	77.9%
男女合計	199	80.2%	231	61.6%	260	51.8%	342	52.0%	207	51.2%	214	49.5%	426	49.7%	286	61.6%	78	67.2%	2243	55.3%
無回答																				
男性	0	0.0%	0	0.0%	0	0.0%	2	0.6%	1	0.5%	3	1.4%	8	1.9%	5	2.7%	2	4.7%	21	1.1%
女性	3	2.4%	1	0.5%	3	1.1%	10	2.9%	3	1.4%	6	2.7%	28	6.6%	32	11.6%	3	4.1%	89	4.2%
男女合計	3	1.2%	1	0.3%	3	0.6%	12	1.8%	4	1.0%	9	2.1%	36	4.2%	37	8.0%	5	4.3%	110	2.7%
全体(人)																				
男性	123		192		238		312		196		211		432		187		43		1934	
女性	125		183		264		346		208		221		425		277		73		2122	
男女合計	248		375		502		658		404		432		857		464		116		4056	

県 北

	20	割合	30	割合	40	割合	50	割合	64	割合	69	割合	70～	割合	全体数	割合
1と回答																
男性	5	10.6%	14	31.8%	21	36.8%	22	25.3%	13	26.5%	19	36.5%	19	13.5%	113	23.7%
女性	2	4.4%	5	11.1%	6	8.7%	7	6.6%	1	2.3%	3	5.5%	7	3.7%	31	5.6%
男女合計	7	7.6%	19	21.3%	27	21.4%	29	15.0%	14	15.1%	22	20.6%	26	7.9%	144	14.0%
2と回答																
男性	1	2.1%	1	2.3%	1	1.8%	2	2.3%	0	0.0%	0	0.0%	1	0.7%	6	1.3%
女性	0	0.0%	0	0.0%	1	1.4%	0	0.0%	0	0.0%	0	0.0%	0	0.0%	1	0.2%
男女合計	1	1.1%	1	1.1%	2	1.6%	2	1.0%	0	0.0%	0	0.0%	1	0.3%	7	0.7%
3と回答																
男性	2	4.3%	11	25.0%	14	24.6%	31	35.6%	19	38.8%	24	46.2%	85	60.3%	186	39.0%
女性	1	2.2%	6	13.3%	9	13.0%	12	11.3%	9	20.5%	6	10.9%	14	7.4%	57	10.3%
男女合計	3	3.3%	17	19.1%	23	18.3%	43	22.3%	28	30.1%	30	28.0%	99	30.0%	243	23.6%
4と回答																
男性	39	83.0%	18	40.9%	21	36.8%	30	34.5%	17	34.7%	9	17.3%	31	22.0%	165	34.6%
女性	39	86.7%	34	75.6%	53	76.8%	81	76.4%	33	75.0%	45	81.8%	147	77.8%	432	78.1%
男女合計	78	84.8%	52	58.4%	74	58.7%	111	57.5%	50	53.8%	54	50.5%	178	53.9%	597	58.0%
無回答																
男性	0	0.0%	0	0.0%	0	0.0%	2	2.3%	0	0.0%	0	0.0%	5	3.5%	7	1.5%
女性	3	6.7%	0	0.0%	0	0.0%	0	0.0%	1	2.3%	1	1.8%	21	11.1%	32	5.8%
男女合計	3	3.3%	0	0.0%	0	0.0%	8	4.1%	1	1.1%	1	0.9%	26	7.9%	39	3.8%
全体(人)																
男性	47		44		57		87		49		52		141		477	
女性	45		45		69		106		44		55		189		553	
男女合計	92		89		126		193		93		107		330		1030	

県 中

	20	割合	30	割合	40	割合	50	割合	64	割合	69	割合	70～	割合	全体数	割合
1と回答																
男性	4	12.5%	11	21.6%	19	28.8%	38	43.2%	16	34.0%	11	25.0%	19	13.3%	118	25.1%
女性	5	13.5%	2	3.7%	9	12.3%	6	7.6%	3	6.0%	2	4.5%	3	1.9%	30	6.1%
男女合計	9	13.0%	13	12.4%	28	20.1%	44	26.3%	19	19.6%	13	14.8%	22	7.3%	148	15.3%
2と回答																
男性	1	3.1%	0	0.0%	2	3.0%	2	2.3%	0	0.0%	0	0.0%	0	0.0%	5	1.1%
女性	0	0.0%	2	3.7%	0	0.0%	0	0.0%	0	0.0%	0	0.0%	1	0.6%	3	0.6%
男女合計	1	1.4%	2	1.9%	2	1.4%	2	1.2%	0	0.0%	0	0.0%	1	0.3%	8	0.8%
3と回答																
男性	5	15.6%	13	25.5%	23	34.8%	27	30.7%	23	48.9%	26	59.1%	79	55.2%	196	41.6%
女性	1	2.7%	9	16.7%	9	12.3%	14	17.7%	6	12.0%	8	18.2%	18	11.4%	65	13.1%
男女合計	6	8.7%	22	21.0%	32	23.0%	41	24.6%	29	29.9%	34	38.6%	97	32.2%	261	27.0%
4と回答																
男性	22	68.8%	27	52.9%	22	33.3%	21	23.9%	7	14.9%	6	13.6%	42	29.4%	147	31.2%
女性	31	83.8%	40	74.1%	54	74.0%	57	72.2%	40	80.0%	32	72.7%	125	79.1%	379	76.6%
男女合計	53	76.8%	67	63.8%	76	54.7%	78	46.7%	47	48.5%	38	43.2%	167	55.5%	526	54.5%
無回答																
男性	0	0.0%	0	0.0%	0	0.0%	0	0.0%	1	2.1%	1	2.3%	3	2.1%	5	1.1%
女性	0	0.0%	1	1.9%	1	1.4%	2	2.5%	1	2.0%	2	4.5%	11	7.0%	18	3.6%
男女合計	0	0.0%	1	1.0%	1	0.7%	2	1.2%	2	2.1%	3	3.4%	14	4.7%	23	2.4%
全体(人)																
男性	32		51		66		88		47		44		143		471	
女性	37		54		73		79		50		44		158		495	
男女合計	69		105		139		167		97		88		301		966	

県 南

	20	割合	30	割合	40	割合	50	割合	64	割合	69	割合	70～	割合	全体数	割合
1と回答																
男性	4	57.1%	9	45.0%	6	28.6%	10	29.4%	7	33.3%	3	14.3%	11	13.9%	50	24.6%
女性	0	0.0%	2	13.3%	5	17.9%	4	11.4%	2	7.7%	0	0.0%	1	1.0%	14	5.9%
男女合計	4	22.2%	11	31.4%	11	22.4%	14	20.3%	9	19.1%	3	6.7%	12	6.8%	64	14.6%
2と回答																
男性	0	0.0%	0	0.0%	1	4.8%	2	5.9%	0	0.0%	0	0.0%	1	1.3%	4	2.0%
女性	1	9.1%	0	0.0%	1	3.6%	1	2.9%	0	0.0%	0	0.0%	0	0.0%	3	1.3%
男女合計	1	5.6%	0	0.0%	2	4.1%	3	4.3%	0	0.0%	0	0.0%	1	0.6%	7	1.6%
3と回答																
男性	0	0.0%	2	10.0%	8	38.1%	14	41.2%	10	47.6%	14	66.7%	41	51.9%	89	43.8%
女性	1	9.1%	2	13.3%	4	14.3%	2	5.7%	5	19.2%	2	8.3%	4	4.1%	20	8.5%
男女合計	1	5.6%	4	11.4%	12	24.5%	16	23.2%	15	31.9%	16	35.6%	45	25.6%	109	24.8%
4と回答																
男性	3	42.9%	9	45.0%	6	28.6%	8	23.5%	4	19.0%	3	14.3%	23	29.1%	56	27.6%
女性	9	81.8%	11	73.3%	17	60.7%	28	80.0%	19	73.1%	22	91.7%	82	84.5%	188	79.7%
男女合計	12	66.7%	20	57.1%	23	46.9%	36	52.2%	23	48.9%	25	55.6%	105	59.7%	244	55.6%
無回答																
男性	0	0.0%	0	0.0%	0	0.0%	0	0.0%	0	0.0%	1	4.8%	3	3.8%	4	2.0%
女性	0	0.0%	0	0.0%	1	3.6%	0	0.0%	0	0.0%	0	0.0%	10	10.3%	11	4.7%
男女合計	0	0.0%	0	0.0%	1	2.0%	0	0.0%	0	0.0%	1	2.2%	13	7.4%	15	3.4%
全体(人)																
男性	7		20		21		34		21		21		79		203	
女性	11		15		28		35		26		24		97		236	
男女合計	18		35		49		69		47		45		176		439	

会 津

	20	割合	30	割合	40	割合	50	割合	64	割合	69	割合	70～	割合	全体数	割合
1と回答																
男性	0	0.0%	7	25.0%	12	27.9%	15	46.9%	3	13.6%	5	20.0%	8	8.1%	50	18.7%
女性	0	0.0%	3	12.0%	6	15.8%	6	14.3%	0	0.0%	3	9.4%	6	5.1%	24	8.2%
男女合計	0	0.0%	10	18.9%	18	22.2%	21	28.4%	3	6.0%	8	14.0%	14	6.5%	74	13.2%
2と回答																
男性	4	22.2%	1	3.6%	0	0.0%	2	6.3%	1	4.5%	0	0.0%	0	0.0%	8	3.0%
女性	0	0.0%	1	4.0%	1	2.6%	0	0.0%	0	0.0%	0	0.0%	1	0.9%	3	1.0%
男女合計	4	13.8%	2	3.8%	1	1.2%	2	2.7%	1	2.0%	0	0.0%	1	0.5%	11	2.0%
3と回答																
男性	1	5.6%	7	25.0%	22	51.2%	11	34.4%	12	54.5%	15	60.0%	74	74.7%	142	53.2%
女性	0	0.0%	4	16.0%	8	21.1%	3	7.1%	5	17.9%	5	15.6%	8	6.8%	33	11.3%
男女合計	1	3.4%	11	20.8%	30	37.0%	14	18.9%	17	34.0%	20	35.1%	82	38.0%	175	31.3%
4と回答																
男性	13	72.2%	13	46.4%	9	20.9%	4	12.5%	6	27.3%	5	20.0%	17	17.2%	67	25.1%
女性	11	100.0%	17	68.0%	23	60.5%	32	76.2%	23	82.1%	23	71.9%	93	79.5%	222	75.8%
男女合計	24	82.8%	30	56.6%	32	39.5%	36	48.6%	29	58.0%	28	49.1%	110	50.9%	289	51.6%
無回答																
男性	0	0.0%	0	0.0%	0	0.0%	0	0.0%	0	0.0%	0	0.0%	0	0.0%	0	0.0%
女性	0	0.0%	0	0.0%	0	0.0%	1	2.4%	0	0.0%	1	3.1%	9	7.7%	11	3.8%
男女合計	0	0.0%	0	0.0%	0	0.0%	1	1.4%	0	0.0%	1	1.8%	9	4.2%	11	2.0%
全体(人)																
男性	18		28		43		32		22		25		99		267	
女性	11		25		38		42		28		32		117		293	
男女合計	29		53		81		74		50		57		216		560	

南 会 津

	20	割合	30	割合	40	割合	50	割合	64	割合	69	割合	70～	割合	全体数	割合
1と回答																
男性	1	33.3%	1	50.0%	0	0.0%	1	33.3%	0	0.0%	1	25.0%	2	14.3%	6	20.0%
女性	0	0.0%	1	50.0%	0	0.0%	0	0.0%	0	0.0%	0	0.0%	0	0.0%	1	3.8%
男女合計	1	33.3%	2	50.0%	0	0.0%	1	25.0%	0	0.0%	1	12.5%	2	7.4%	7	12.5%
2と回答																
男性	0	0.0%	0	0.0%	1	33.3%	0	0.0%	0	0.0%	0	0.0%	0	0.0%	1	3.3%
女性	0	0.0%	0	0.0%	0	0.0%	0	0.0%	0	0.0%	0	0.0%	0	0.0%	0	0.0%
男女合計	0	0.0%	0	0.0%	1	16.7%	0	0.0%	0	0.0%	0	0.0%	0	0.0%	1	1.8%
3と回答																
男性	0	0.0%	0	0.0%	0	0.0%	1	33.3%	1	100.0%	3	75.0%	9	64.3%	14	46.7%
女性	0	0.0%	0	0.0%	0	0.0%	0	0.0%	1	33.3%	1	25.0%	0	0.0%	2	7.7%
男女合計	0	0.0%	0	0.0%	0	0.0%	1	25.0%	2	50.0%	4	50.0%	9	33.3%	16	28.6%
4と回答																
男性	2	66.7%	1	50.0%	2	66.7%	1	33.3%	0	0.0%	0	0.0%	2	14.3%	8	26.7%
女性	0	0.0%	1	50.0%	3	100.0%	1	100.0%	2	66.7%	3	75.0%	12	92.3%	22	84.6%
男女合計	2	66.7%	2	50.0%	5	83.3%	2	50.0%	2	50.0%	3	37.5%	14	51.9%	30	53.6%
無回答																
男性	0	0.0%	0	0.0%	0	0.0%	0	0.0%	0	0.0%	0	0.0%	1	7.1%	1	3.3%
女性	0	0.0%	0	0.0%	0	0.0%	0	0.0%	0	0.0%	0	0.0%	1	7.7%	1	3.8%
男女合計	0	0.0%	0	0.0%	0	0.0%	0	0.0%	0	0.0%	0	0.0%	2	7.4%	2	3.6%
全体(人)																
男性	3		2		3		3		1		4		14		30	
女性	0		2		3		1		3		4		13		26	
男女合計	3		4		6		4		4		8		27		56	

相 双

	20	割合	30	割合	40	割合	50	割合	64	割合	69	割合	70～	割合	全体数	割合
1と回答																
男性	1	16.7%	2	16.7%	9	50.0%	6	30.0%	4	28.6%	6	30.0%	8	14.0%	36	24.5%
女性	0	0.0%	2	14.3%	4	16.7%	1	5.0%	0	0.0%	0	0.0%	1	1.7%	8	5.3%
男女合計	1	10.0%	4	15.4%	13	31.0%	7	17.5%	4	16.0%	6	15.4%	9	7.7%	44	14.7%
2と回答																
男性	0	0.0%	1	8.3%	1	5.6%	1	5.0%	0	0.0%	0	0.0%	1	1.8%	4	2.7%
女性	0	0.0%	0	0.0%	0	0.0%	0	0.0%	0	0.0%	0	0.0%	0	0.0%	0	0.0%
男女合計	0	0.0%	1	3.8%	1	2.4%	1	2.5%	0	0.0%	0	0.0%	1	0.9%	4	1.3%
3と回答																
男性	0	0.0%	1	8.3%	4	22.2%	8	40.0%	5	35.7%	9	45.0%	30	52.6%	57	38.8%
女性	0	0.0%	1	7.1%	4	16.7%	1	5.0%	2	18.2%	1	5.3%	4	6.7%	13	8.6%
男女合計	0	0.0%	2	7.7%	8	19.0%	9	22.5%	7	28.0%	10	25.6%	34	29.1%	70	23.4%
4と回答																
男性	5	83.3%	8	66.7%	4	22.2%	5	25.0%	5	35.7%	5	25.0%	17	29.8%	49	33.3%
女性	4	100.0%	11	78.6%	15	62.5%	17	85.0%	9	81.8%	17	89.5%	51	85.0%	124	81.6%
男女合計	9	90.0%	19	73.1%	19	45.2%	22	55.0%	14	56.0%	22	56.4%	68	58.1%	173	57.9%
無回答																
男性	0	0.0%	0	0.0%	0	0.0%	0	0.0%	0	0.0%	0	0.0%	1	1.8%	1	0.7%
女性	0	0.0%	0	0.0%	1	4.2%	1	5.0%	0	0.0%	1	5.3%	4	6.7%	7	4.6%
男女合計	0	0.0%	0	0.0%	1	2.4%	1	2.5%	0	0.0%	1	2.6%	5	4.3%	8	2.7%
全体(人)																
男性	6		12		18		20		14		20		57		147	
女性	4		14		24		20		11		19		60		152	
男女合計	10		26		42		40		25		39		117		299	

いわき

	20	割合	30	割合	40	割合	50	割合	64	割合	69	割合	70～	割合	全体数	割合
1と回答																
男性	1	10.0%	10	28.6%	11	36.7%	13	27.1%	18	42.9%	7	15.6%	11	8.5%	71	20.9%
女性	1	5.9%	1	3.6%	2	6.9%	8	12.7%	4	8.7%	4	9.3%	3	2.1%	23	6.3%
男女合計	2	7.4%	11	17.5%	13	22.0%	21	18.9%	22	25.0%	11	12.5%	14	5.2%	94	13.3%
2と回答																
男性	1	10.0%	1	2.9%	0	0.0%	1	2.1%	0	0.0%	0	0.0%	1	0.8%	4	1.2%
女性	0	0.0%	1	3.6%	0	0.0%	1	1.6%	0	0.0%	0	0.0%	0	0.0%	2	0.5%
男女合計	1	3.7%	2	3.2%	0	0.0%	2	1.8%	0	0.0%	0	0.0%	1	0.4%	6	0.8%
3と回答																
男性	2	20.0%	6	17.1%	6	20.0%	25	52.1%	13	31.0%	27	60.0%	84	65.1%	163	48.1%
女性	1	5.9%	3	10.7%	9	31.0%	6	9.5%	10	21.7%	4	9.3%	14	9.9%	47	12.8%
男女合計	3	11.1%	9	14.3%	15	25.4%	31	27.9%	23	26.1%	31	35.2%	98	36.3%	210	29.7%
4と回答																
男性	6	60.0%	18	51.4%	13	43.3%	9	18.8%	11	26.2%	10	22.2%	31	24.0%	98	28.9%
女性	15	88.2%	23	82.1%	18	62.1%	48	76.2%	31	67.4%	34	79.1%	117	83.0%	286	77.9%
男女合計	21	77.8%	41	65.1%	31	52.5%	57	51.4%	42	47.7%	44	50.0%	148	54.8%	384	54.4%
無回答																
男性	0	0.0%	0	0.0%	0	0.0%	0	0.0%	0	0.0%	1	2.2%	2	1.6%	3	0.9%
女性	0	0.0%	0	0.0%	0	0.0%	0	0.0%	1	2.2%	1	2.3%	7	5.0%	9	2.5%
男女合計	0	0.0%	0	0.0%	0	0.0%	0	0.0%	1	1.1%	2	2.3%	9	3.3%	12	1.7%
全体(人)																
男性	10		35		30		48		42		45		129		339	
女性	17		28		29		63		46		43		141		367	
男女合計	27		63		59		111		88		88		270		706	

(2) 禁煙の意思 (満20歳以上対象) (調査票 問11付問)

付問 問11で1～2を選んだ方におたずねします。あなたは、たばこをやめたいと思いますか。(あてはまる番号1つに○)

- 1 やめたい 2 本数を減らしたい
3 やめたくない 4 わからない

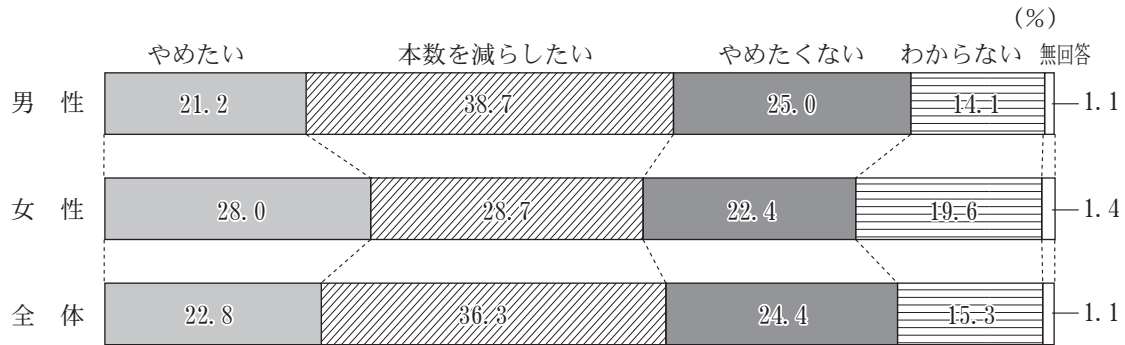

	20	割合	30	割合	40	割合	50	割合	64	割合	69	割合	70	割合	80	割合	90	割合	全体数	割合
1と回答																				
男性	5	21.7%	14	24.1%	15	17.9%	22	19.1%	19	30.6%	6	11.5%	20	27.4%	0	0.0%	0	0.0%	101	21.2%
女性	1	11.1%	6	30.0%	9	25.7%	9	26.5%	3	30.0%	7	58.3%	3	16.7%	2	50.0%	0	0.0%	40	28.0%
男女合計	6	18.8%	20	25.6%	24	20.2%	31	20.8%	22	30.6%	13	20.3%	23	25.3%	2	18.2%	0	0.0%	141	22.8%
2と回答																				
男性	8	34.8%	20	34.5%	30	35.7%	45	39.1%	21	33.9%	27	51.9%	30	41.1%	3	42.9%	0	0.0%	184	38.7%
女性	4	44.4%	4	20.0%	9	25.7%	9	26.5%	5	50.0%	4	33.3%	5	27.8%	1	25.0%	0	0.0%	41	28.7%
男女合計	12	37.5%	24	30.8%	39	32.8%	54	36.2%	26	36.1%	31	48.4%	35	38.5%	4	36.4%	0	0.0%	225	36.3%
3と回答																				
男性	4	17.4%	15	25.9%	20	23.8%	30	26.1%	16	25.8%	14	26.9%	14	19.2%	4	57.1%	2	100.0%	119	25.0%
女性	0	0.0%	6	30.0%	9	25.7%	7	20.6%	1	10.0%	1	8.3%	7	38.9%	1	25.0%	0	0.0%	32	22.4%
男女合計	4	12.5%	21	26.9%	29	24.4%	37	24.8%	17	23.6%	15	23.4%	21	23.1%	5	45.5%	2	66.7%	151	24.4%
4と回答																				
男性	6	26.1%	8	13.8%	17	20.2%	16	13.9%	6	9.7%	5	9.6%	9	12.3%	0	0.0%	0	0.0%	67	14.1%
女性	4	44.4%	3	15.0%	8	22.9%	8	23.5%	1	10.0%	0	0.0%	3	16.7%	0	0.0%	1	100.0%	28	19.6%
男女合計	10	31.3%	11	14.1%	25	21.0%	24	16.1%	7	9.7%	5	7.8%	12	13.2%	0	0.0%	1	33.3%	95	15.3%
無回答																				
男性	0	0.0%	1	1.7%	2	2.4%	2	1.7%	0	0.0%	0	0.0%	0	0.0%	0	0.0%	0	0.0%	5	1.1%
女性	0	0.0%	1	5.0%	0	0.0%	1	2.9%	0	0.0%	0	0.0%	0	0.0%	0	0.0%	0	0.0%	2	1.4%
男女合計	0	0.0%	2	2.6%	2	1.7%	3	2.0%	0	0.0%	0	0.0%	0	0.0%	0	0.0%	0	0.0%	7	1.1%
全体(人)																				
男性	23	58	84	115	62	52	73	7	2	476										
女性	9	20	35	34	10	12	18	4	1	143										
男女合計	32	78	119	149	72	64	91	11	3	619										

県 北

	20	割合	30	割合	40	割合	50	割合	64	割合	69	割合	70～	割合	全体数	割合
1と回答																
男性	2	33.3%	4	26.7%	6	27.3%	2	8.3%	4	30.8%	2	10.5%	4	20.0%	24	20.2%
女性	0	0.0%	2	40.0%	3	42.9%	3	42.9%	0	0.0%	1	33.3%	1	14.3%	10	31.3%
男女合計	2	25.0%	6	30.0%	9	31.0%	5	16.1%	4	28.6%	3	13.6%	5	18.5%	34	22.5%
2と回答																
男性	2	33.3%	6	40.0%	8	36.4%	10	41.7%	3	23.1%	10	52.6%	12	60.0%	51	42.9%
女性	0	0.0%	1	20.0%	1	14.3%	4	57.1%	1	100.0%	2	66.7%	1	14.3%	10	31.3%
男女合計	2	25.0%	7	35.0%	9	31.0%	14	45.2%	4	28.6%	12	54.5%	13	48.1%	61	40.4%
3と回答																
男性	1	16.7%	3	20.0%	5	22.7%	7	29.2%	5	38.5%	6	31.6%	3	15.0%	30	25.2%
女性	0	0.0%	2	40.0%	1	14.3%	0	0.0%	0	0.0%	0	0.0%	3	42.9%	6	18.8%
男女合計	1	12.5%	5	25.0%	6	20.7%	7	22.6%	5	35.7%	6	27.3%	6	22.2%	36	23.8%
4と回答																
男性	1	16.7%	2	13.3%	3	13.6%	5	20.8%	1	7.7%	1	5.3%	1	5.0%	14	11.8%
女性	2	100.0%	0	0.0%	2	28.6%	0	0.0%	0	0.0%	0	0.0%	2	28.6%	6	18.8%
男女合計	3	37.5%	2	10.0%	5	17.2%	5	16.1%	1	7.1%	1	4.5%	3	11.1%	20	13.2%
無回答																
男性	0	0.0%	0	0.0%	0	0.0%	0	0.0%	0	0.0%	0	0.0%	0	0.0%	0	0.0%
女性	0	0.0%	0	0.0%	0	0.0%	0	0.0%	0	0.0%	0	0.0%	0	0.0%	0	0.0%
男女合計	0	0.0%	0	0.0%	0	0.0%	0	0.0%	0	0.0%	0	0.0%	0	0.0%	0	0.0%
全体(人)																
男性	6		15		22		24		13		19		20		119	
女性	2		5		7		7		1		3		7		32	
男女合計	8		20		29		31		14		22		27		151	

県 中

	20	割合	30	割合	40	割合	50	割合	64	割合	69	割合	70～	割合	全体数	割合
1と回答																
男性	1	20.0%	5	45.5%	1	4.8%	10	25.0%	6	37.5%	1	9.1%	3	15.8%	27	22.0%
女性	1	20.0%	2	50.0%	1	11.1%	0	0.0%	2	66.7%	1	50.0%	3	75.0%	10	30.3%
男女合計	2	20.0%	7	46.7%	2	6.7%	10	21.7%	8	42.1%	2	15.4%	6	26.1%	37	23.7%
2と回答																
男性	3	60.0%	3	27.3%	8	38.1%	17	42.5%	6	37.5%	7	63.6%	6	31.6%	50	40.7%
女性	3	60.0%	0	0.0%	3	33.3%	1	16.7%	1	33.3%	1	50.0%	1	25.0%	10	30.3%
男女合計	6	60.0%	3	20.0%	11	36.7%	18	39.1%	7	36.8%	8	61.5%	7	30.4%	60	38.5%
3と回答																
男性	0	0.0%	3	27.3%	8	38.1%	10	25.0%	3	18.8%	3	27.3%	7	36.8%	34	27.6%
女性	0	0.0%	1	25.0%	3	33.3%	2	33.3%	0	0.0%	0	0.0%	0	0.0%	6	18.2%
男女合計	0	0.0%	4	26.7%	11	36.7%	12	26.1%	3	15.8%	3	23.1%	7	30.4%	40	25.6%
4と回答																
男性	1	20.0%	0	0.0%	4	19.0%	2	5.0%	1	6.3%	0	0.0%	3	15.8%	11	8.9%
女性	1	20.0%	1	25.0%	2	22.2%	3	50.0%	0	0.0%	0	0.0%	0	0.0%	7	21.2%
男女合計	2	20.0%	1	6.7%	6	20.0%	5	10.9%	1	5.3%	0	0.0%	3	13.0%	18	11.5%
無回答																
男性	0	0.0%	0	0.0%	0	0.0%	1	2.5%	0	0.0%	0	0.0%	0	0.0%	1	0.8%
女性	0	0.0%	0	0.0%	0	0.0%	0	0.0%	0	0.0%	0	0.0%	0	0.0%	0	0.0%
男女合計	0	0.0%	0	0.0%	0	0.0%	1	2.2%	0	0.0%	0	0.0%	0	0.0%	1	0.6%
全体(人)																
男性	5		11		21		40		16		11		19		123	
女性	5		4		9		6		3		2		4		33	
男女合計	10		15		30		46		19		13		23		156	

県 南

	20	割合	30	割合	40	割合	50	割合	64	割合	69	割合	70～	割合	全体数	割合
1と回答																
男性	1	25.0%	0	0.0%	0	0.0%	3	25.0%	2	28.6%	0	0.0%	5	41.7%	11	20.4%
女性	0	0.0%	1	50.0%	2	33.3%	1	20.0%	0	0.0%	0	0.0%	0	0.0%	4	23.5%
男女合計	1	20.0%	1	9.1%	2	15.4%	4	23.5%	2	22.2%	0	0.0%	5	38.5%	15	21.1%
2と回答																
男性	1	25.0%	3	33.3%	2	28.6%	5	41.7%	3	42.9%	1	33.3%	3	25.0%	18	33.3%
女性	0	0.0%	1	50.0%	1	16.7%	1	20.0%	2	100.0%	0	0.0%	1	100.0%	6	35.3%
男女合計	1	20.0%	4	36.4%	3	23.1%	6	35.3%	5	55.6%	1	33.3%	4	30.8%	24	33.8%
3と回答																
男性	1	25.0%	4	44.4%	1	14.3%	1	8.3%	2	28.6%	2	66.7%	4	33.3%	15	27.8%
女性	0	0.0%	0	0.0%	0	0.0%	0	0.0%	0	0.0%	0	0.0%	0	0.0%	0	0.0%
男女合計	1	20.0%	4	36.4%	1	7.7%	1	5.9%	2	22.2%	2	66.7%	4	30.8%	15	21.1%
4と回答																
男性	1	25.0%	2	22.2%	4	57.1%	3	25.0%	0	0.0%	0	0.0%	0	0.0%	10	18.5%
女性	1	100.0%	0	0.0%	3	50.0%	2	40.0%	0	0.0%	0	0.0%	0	0.0%	6	35.3%
男女合計	2	40.0%	2	18.2%	7	53.8%	5	29.4%	0	0.0%	0	0.0%	0	0.0%	16	22.5%
無回答																
男性	0	0.0%	0	0.0%	0	0.0%	0	0.0%	0	0.0%	0	0.0%	0	0.0%	0	0.0%
女性	0	0.0%	0	0.0%	0	0.0%	1	20.0%	0	0.0%	0	0.0%	0	0.0%	1	5.9%
男女合計	0	0.0%	0	0.0%	0	0.0%	1	5.9%	0	0.0%	0	0.0%	0	0.0%	1	1.4%
全体(人)																
男性	4		9		7		12		7		3		12		54	
女性	1		2		6		5		2		0		1		17	
男女合計	5		11		13		17		9		3		13		71	

会 津

	20	割合	30	割合	40	割合	50	割合	64	割合	69	割合	70～	割合	全体数	割合
1と回答																
男 性	0	0.0%	2	25.0%	3	25.0%	2	11.8%	4	100.0%	1	20.0%	1	12.5%	13	22.4%
女 性	0	0.0%	0	0.0%	2	28.6%	2	33.3%	0	0.0%	3	100.0%	1	14.3%	8	29.6%
男女合計	0	0.0%	2	16.7%	5	26.3%	4	17.4%	4	100.0%	4	50.0%	2	13.3%	21	24.7%
2と回答																
男 性	0	0.0%	3	37.5%	6	50.0%	7	41.2%	0	0.0%	2	40.0%	4	50.0%	22	37.9%
女 性	0	0.0%	1	25.0%	3	42.9%	0	0.0%	0	0.0%	0	0.0%	1	14.3%	5	18.5%
男女合計	0	0.0%	4	33.3%	9	47.4%	7	30.4%	0	0.0%	2	25.0%	5	33.3%	27	31.8%
3と回答																
男 性	2	50.0%	2	25.0%	2	16.7%	3	17.6%	0	0.0%	2	40.0%	1	12.5%	12	20.7%
女 性	0	0.0%	2	50.0%	2	28.6%	2	33.3%	0	0.0%	0	0.0%	4	57.1%	10	37.0%
男女合計	2	50.0%	4	33.3%	4	21.1%	5	21.7%	0	0.0%	2	25.0%	5	33.3%	22	25.9%
4と回答																
男 性	2	50.0%	1	12.5%	1	8.3%	4	23.5%	0	0.0%	0	0.0%	2	25.0%	10	17.2%
女 性	0	0.0%	1	25.0%	0	0.0%	2	33.3%	0	0.0%	0	0.0%	1	14.3%	4	14.8%
男女合計	2	50.0%	2	16.7%	1	5.3%	6	26.1%	0	0.0%	0	0.0%	3	20.0%	14	16.5%
無回答																
男 性	0	0.0%	0	0.0%	0	0.0%	1	5.9%	0	0.0%	0	0.0%	0	0.0%	1	1.7%
女 性	0	0.0%	0	0.0%	0	0.0%	0	0.0%	0	0.0%	0	0.0%	0	0.0%	0	0.0%
男女合計	0	0.0%	0	0.0%	0	0.0%	1	4.3%	0	0.0%	0	0.0%	0	0.0%	1	1.2%
全体(人)																
男 性	4		8		12		17		4		5		8		58	
女 性	0		4		7		6		0		3		7		27	
男女合計	4		12		19		23		4		8		15		85	

南 会 津

	20	割合	30	割合	40	割合	50	割合	64	割合	69	割合	70～	割合	全体数	割合
1と回答																
男 性	0	0.0%	1	100.0%	0	0.0%	0	0.0%	0	0.0%	0	0.0%	1	50.0%	2	28.6%
女 性	0	0.0%	0	0.0%	0	0.0%	0	0.0%	0	0.0%	0	0.0%	0	0.0%	0	0.0%
男女合計	0	0.0%	1	50.0%	0	0.0%	0	0.0%	0	0.0%	0	0.0%	1	50.0%	2	25.0%
2と回答																
男 性	0	0.0%	0	0.0%	0	0.0%	1	100.0%	0	0.0%	1	100.0%	0	0.0%	2	28.6%
女 性	0	0.0%	0	0.0%	0	0.0%	0	0.0%	0	0.0%	0	0.0%	0	0.0%	0	0.0%
男女合計	0	0.0%	0	0.0%	0	0.0%	1	100.0%	0	0.0%	1	100.0%	0	0.0%	2	25.0%
3と回答																
男 性	0	0.0%	0	0.0%	0	0.0%	0	0.0%	0	0.0%	0	0.0%	1	50.0%	1	14.3%
女 性	0	0.0%	1	100.0%	0	0.0%	0	0.0%	0	0.0%	0	0.0%	0	0.0%	1	100.0%
男女合計	0	0.0%	1	50.0%	0	0.0%	0	0.0%	0	0.0%	0	0.0%	1	50.0%	2	25.0%
4と回答																
男 性	1	100.0%	0	0.0%	1	100.0%	0	0.0%	0	0.0%	0	0.0%	0	0.0%	2	28.6%
女 性	0	0.0%	0	0.0%	0	0.0%	0	0.0%	0	0.0%	0	0.0%	0	0.0%	0	0.0%
男女合計	1	100.0%	0	0.0%	1	100.0%	0	0.0%	0	0.0%	0	0.0%	0	0.0%	2	25.0%
無回答																
男 性	0	0.0%	0	0.0%	0	0.0%	0	0.0%	0	0.0%	0	0.0%	0	0.0%	0	0.0%
女 性	0	0.0%	0	0.0%	0	0.0%	0	0.0%	0	0.0%	0	0.0%	0	0.0%	0	0.0%
男女合計	0	0.0%	0	0.0%	0	0.0%	0	0.0%	0	0.0%	0	0.0%	0	0.0%	0	0.0%
全体(人)																
男 性	1		1		1		1		0		1		2		7	
女 性	0		1		0		0		0		0		0		1	
男女合計	1		2		1		1		0		1		2		8	

相 双

	20	割合	30	割合	40	割合	50	割合	64	割合	69	割合	70～	割合	全体数	割合
1と回答																
男 性	0	0.0%	0	0.0%	2	20.0%	1	14.3%	0	0.0%	2	33.3%	2	22.2%	7	17.5%
女 性	0	0.0%	0	0.0%	0	0.0%	0	0.0%	0	0.0%	0	0.0%	0	0.0%	0	0.0%
男女合計	0	0.0%	0	0.0%	2	14.3%	1	12.5%	0	0.0%	2	33.3%	2	20.0%	7	14.6%
2と回答																
男 性	1	100.0%	1	33.3%	2	20.0%	1	14.3%	2	50.0%	2	33.3%	4	44.4%	13	32.5%
女 性	0	0.0%	0	0.0%	1	25.0%	1	100.0%	0	0.0%	0	0.0%	0	0.0%	2	25.0%
男女合計	1	100.0%	1	20.0%	3	21.4%	2	25.0%	2	50.0%	2	33.3%	4	40.0%	15	31.3%
3と回答																
男 性	0	0.0%	1	33.3%	2	20.0%	4	57.1%	1	25.0%	1	16.7%	2	22.2%	11	27.5%
女 性	0	0.0%	0	0.0%	3	75.0%	0	0.0%	0	0.0%	0	0.0%	0	0.0%	3	37.5%
男女合計	0	0.0%	1	20.0%	5	35.7%	4	50.0%	1	25.0%	1	16.7%	2	20.0%	14	29.2%
4と回答																
男 性	0	0.0%	1	33.3%	3	30.0%	1	14.3%	1	25.0%	1	16.7%	1	11.1%	8	20.0%
女 性	0	0.0%	1	50.0%	0	0.0%	0	0.0%	0	0.0%	0	0.0%	1	100.0%	2	25.0%
男女合計	0	0.0%	2	40.0%	3	21.4%	1	12.5%	1	25.0%	1	16.7%	2	20.0%	10	20.8%
無回答																
男 性	0	0.0%	0	0.0%	1	10.0%	0	0.0%	0	0.0%	0	0.0%	0	0.0%	1	2.5%
女 性	0	0.0%	1	50.0%	0	0.0%	0	0.0%	0	0.0%	0	0.0%	0	0.0%	1	12.5%
男女合計	0	0.0%	1	20.0%	1	7.1%	0	0.0%	0	0.0%	0	0.0%	0	0.0%	2	4.2%
全体(人)																
男 性	1		3		10		7		4		6		9		40	
女 性	0		2		4		1		0		0		1		8	
男女合計	1		5		14		8		4		6		10		48	

いわき

	20	割合	30	割合	40	割合	50	割合	64	割合	69	割合	70～	割合	全体数	割合
1と回答																
男性	1	50.0%	2	18.2%	3	27.3%	4	28.6%	3	16.7%	0	0.0%	4	33.3%	17	22.7%
女性	0	0.0%	1	50.0%	1	50.0%	3	33.3%	1	25.0%	2	50.0%	0	0.0%	8	32.0%
男女合計	1	33.3%	3	23.1%	4	30.8%	7	30.4%	4	18.2%	2	18.2%	4	26.7%	25	25.0%
2と回答																
男性	1	50.0%	4	36.4%	4	36.4%	4	28.6%	7	38.9%	4	57.1%	4	33.3%	28	37.3%
女性	1	100.0%	1	50.0%	0	0.0%	2	22.2%	1	25.0%	1	25.0%	2	66.7%	8	32.0%
男女合計	2	66.7%	5	38.5%	4	30.8%	6	26.1%	8	36.4%	5	45.5%	6	40.0%	36	36.0%
3と回答																
男性	0	0.0%	2	18.2%	2	18.2%	5	35.7%	5	27.8%	0	0.0%	2	16.7%	16	21.3%
女性	0	0.0%	0	0.0%	0	0.0%	3	33.3%	1	25.0%	1	25.0%	1	33.3%	6	24.0%
男女合計	0	0.0%	2	15.4%	2	15.4%	8	34.8%	6	27.3%	1	9.1%	3	20.0%	22	22.0%
4と回答																
男性	0	0.0%	2	18.2%	1	9.1%	1	7.1%	3	16.7%	3	42.9%	2	16.7%	12	16.0%
女性	0	0.0%	0	0.0%	1	50.0%	1	11.1%	1	25.0%	0	0.0%	0	0.0%	3	12.0%
男女合計	0	0.0%	2	15.4%	2	15.4%	2	8.7%	4	18.2%	3	27.3%	2	13.3%	15	15.0%
無回答																
男性	0	0.0%	1	9.1%	1	9.1%	0	0.0%	0	0.0%	0	0.0%	0	0.0%	2	2.7%
女性	0	0.0%	0	0.0%	0	0.0%	0	0.0%	0	0.0%	0	0.0%	0	0.0%	0	0.0%
男女合計	0	0.0%	1	7.7%	1	7.7%	0	0.0%	0	0.0%	0	0.0%	0	0.0%	2	2.0%
全体(人)																
男性	2		11		11		14		18		7		12		75	
女性	1		2		2		9		4		4		3		25	
男女合計	3		13		13		23		22		11		15		100	

(3) 家族(世帯)の喫煙状況(調査票 問12)

問12 あなたの家族で、あなたを含めて、たばこを吸っている方はいますか。

1 いる 2 いない



	県北	割合	県中	割合	県南	割合	会津	割合	南会津	割合	相双	割合	いわき	割合	全体数	割合
1 いる	158	28.6%	155	30.8%	66	28.9%	81	29.3%	11	35.5%	50	32.5%	102	27.8%	623	29.5%
2 いない	389	70.3%	343	68.2%	161	70.6%	191	69.2%	20	64.5%	101	65.6%	260	70.8%	1,465	69.4%
不明	6	1.1%	5	1.0%	1	0.4%	4	1.4%	0	0.0%	3	1.9%	5	1.4%	24	1.1%
回答世帯数	553		503		228		276		31		154		367		2,112	

13 受動喫煙の状況（調査票 問13）

問13 あなたは、この1か月間に、自分以外の人が吸っていたたばこの煙を吸う機会（受動喫煙）がありましたか。（各場所につき、○は1つ）

- | | |
|-----------|-----------------|
| 1. ほぼ毎日 | 2. 週に数回程度 |
| 3. 週に1回程度 | 4. 月に1回程度 |
| 5. 全くなかった | 6. その場所へは行かなかった |

○家 庭

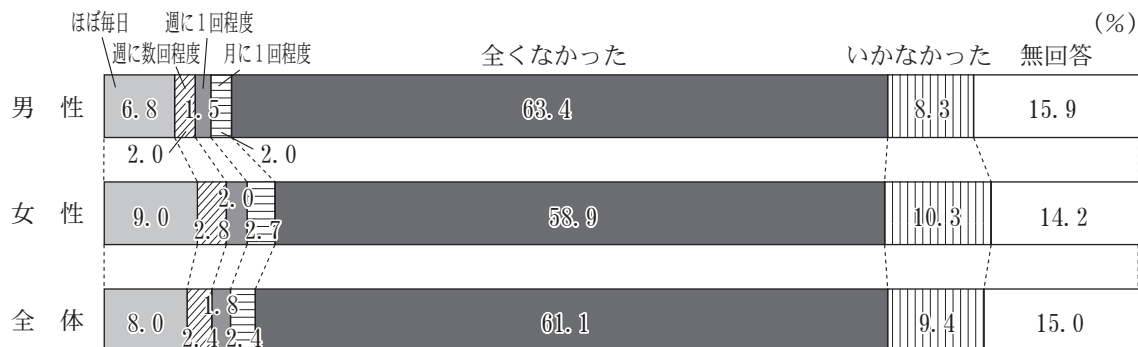

○職 場

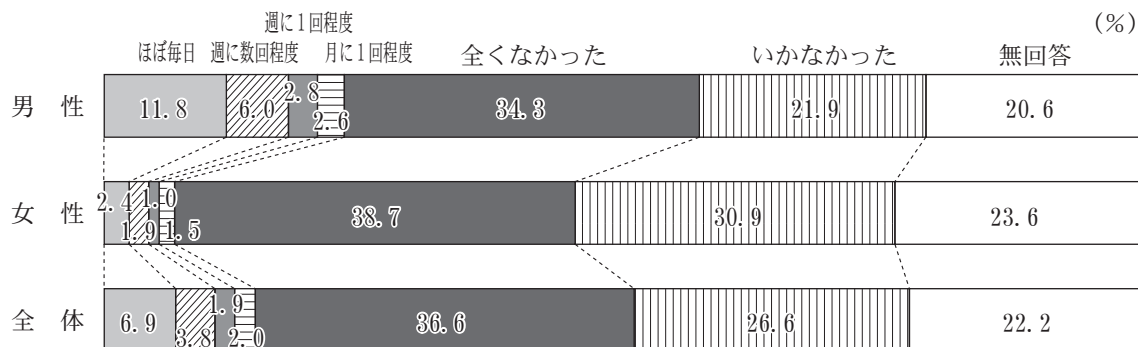

○学 校

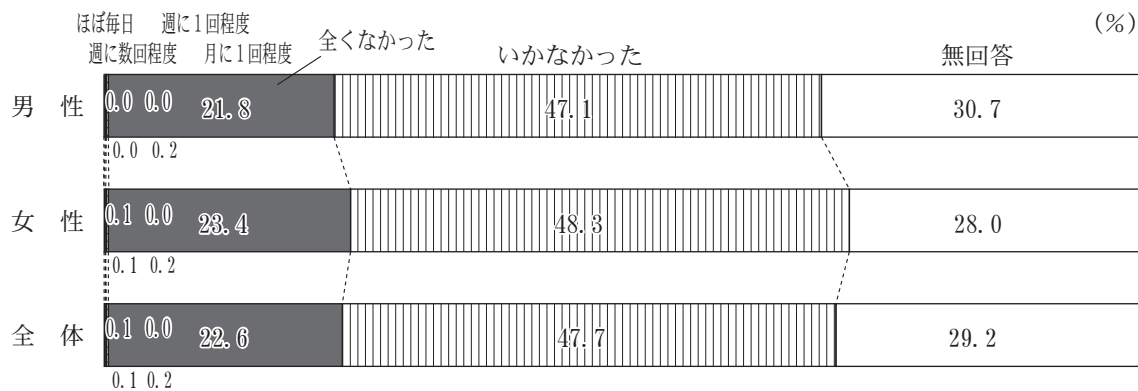

○飲食店

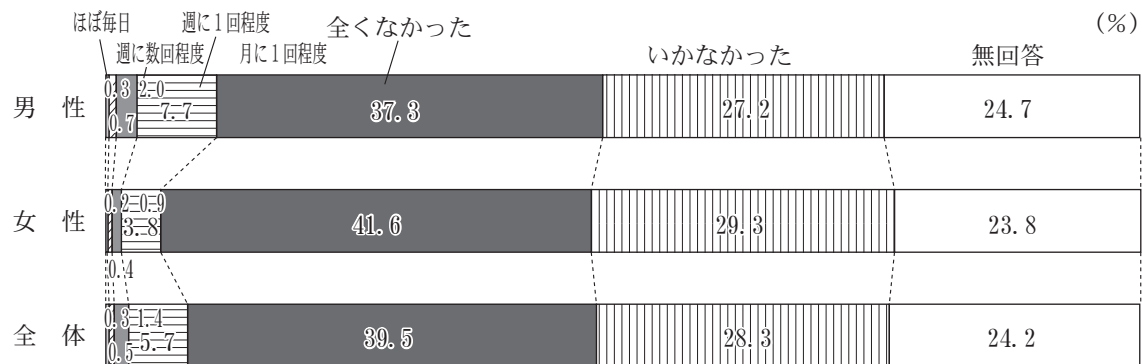

○遊技場



○行政機関

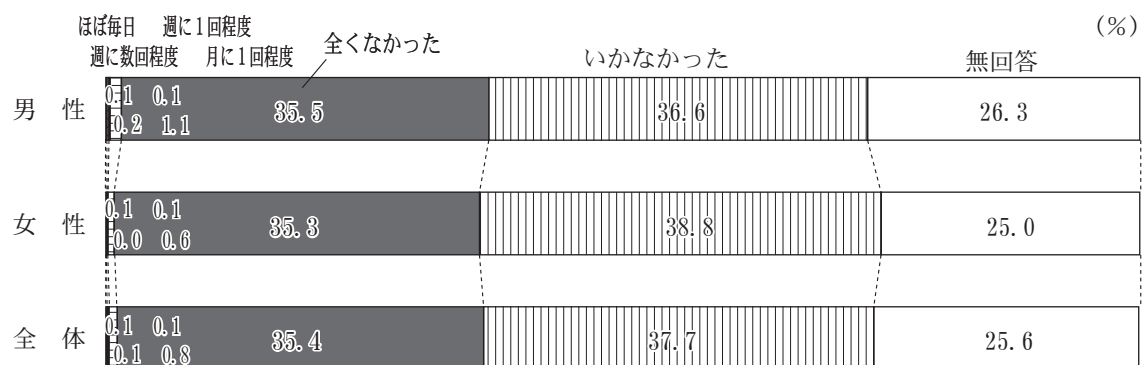

○医療機関

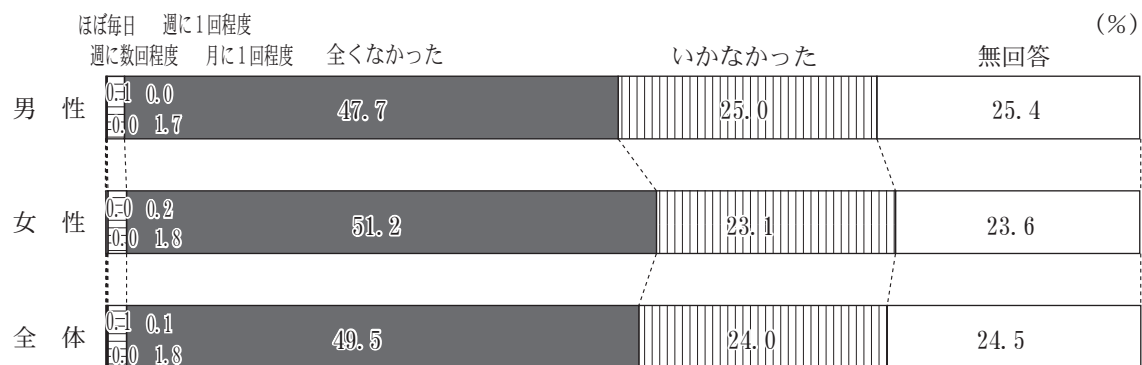

○公共交通機関

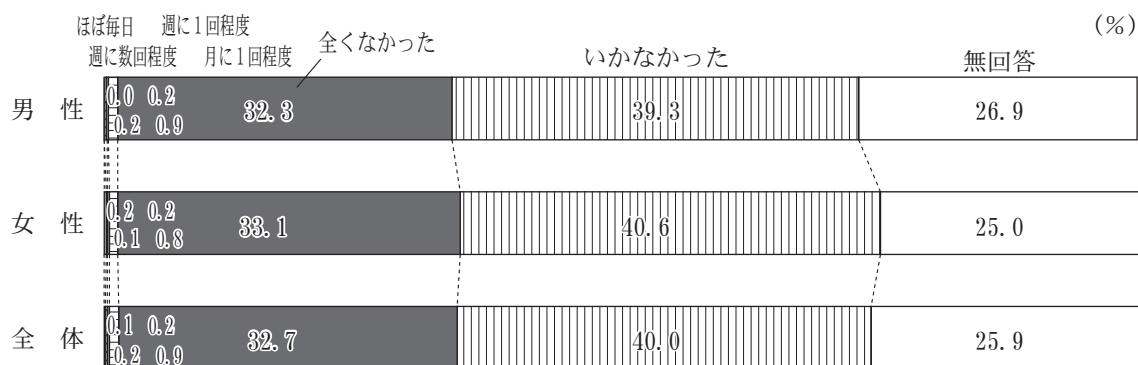

○路上

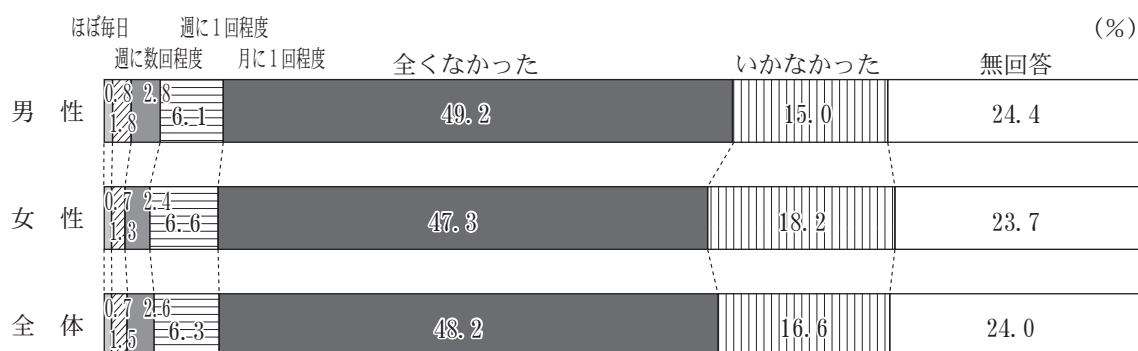

○子供が利用する屋外の空間

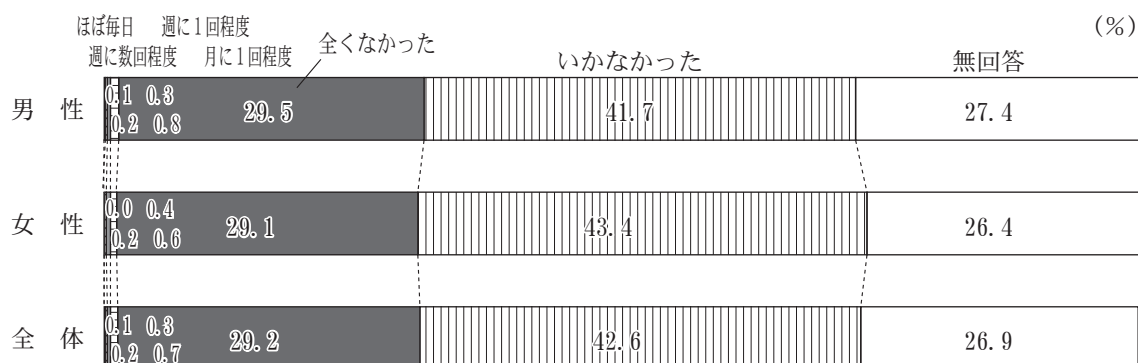

○健康増進施設

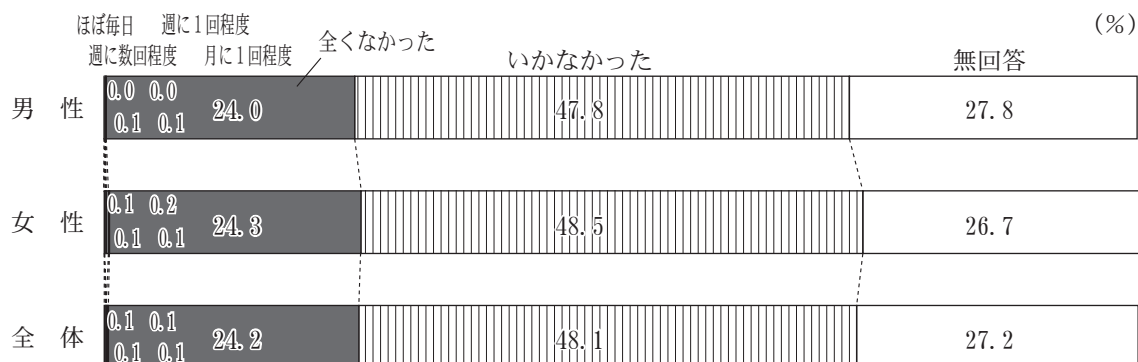

○家 庭

	10	割合	20	割合	30	割合	40	割合	50	割合	64	割合	69	割合	70	割合	80	割合	90	割合	全体数	割合
1 个回答	8	9.8%	10	8.1%	15	7.8%	22	9.2%	25	8.0%	19	9.7%	13	6.2%	17	3.9%	9	4.8%	0	0.0%	138	6.8%
男性	4	5.4%	14	11.2%	18	9.8%	34	12.9%	37	10.7%	24	11.5%	22	10.0%	29	6.8%	10	3.6%	5	6.8%	197	9.0%
女性	4	5.4%	14	11.2%	18	9.8%	34	12.9%	37	10.7%	24	11.5%	22	10.0%	29	6.8%	10	3.6%	5	6.8%	197	9.0%
男女合計	12	7.7%	24	9.7%	33	8.8%	56	11.2%	62	9.4%	43	10.6%	35	8.1%	46	5.4%	19	4.1%	5	4.3%	335	8.0%
2 个回答	5	6.1%	5	4.1%	4	2.1%	5	2.1%	7	2.2%	2	1.0%	3	1.4%	8	1.9%	2	1.1%	0	0.0%	41	2.0%
男性	2	2.7%	5	4.0%	6	3.3%	6	2.3%	13	3.8%	7	3.4%	7	3.2%	10	2.4%	4	1.4%	2	2.7%	62	2.8%
女性	3	3.4%	0	0.0%	0	0.0%	0	0.0%	0	0.0%	0	0.0%	0	0.0%	0	0.0%	0	0.0%	0	0.0%	41	2.0%
男女合計	7	4.5%	10	4.0%	10	2.7%	11	2.2%	20	3.0%	9	2.2%	10	2.3%	18	2.1%	6	1.3%	2	1.7%	103	2.4%
3 个回答	0	0.0%	5	4.1%	1	0.5%	4	1.7%	7	2.2%	3	1.5%	3	1.4%	5	1.2%	3	1.6%	0	0.0%	31	1.5%
男性	0	0.0%	5	4.1%	1	0.5%	4	1.7%	7	2.2%	3	1.5%	3	1.4%	5	1.2%	3	1.6%	0	0.0%	31	1.5%
女性	3	4.1%	5	4.0%	7	3.8%	5	1.9%	6	1.7%	4	1.9%	5	2.3%	7	1.6%	2	0.7%	1	1.4%	45	2.0%
男女合計	3	1.9%	10	4.0%	8	2.1%	9	1.8%	13	2.0%	7	1.7%	8	1.9%	12	1.4%	5	1.1%	1	0.9%	76	1.8%
4 个回答	1	1.2%	2	1.6%	2	1.0%	5	2.1%	3	1.0%	4	2.0%	6	2.8%	12	2.8%	5	2.7%	1	2.3%	41	2.0%
男性	2	2.7%	6	4.8%	5	2.7%	6	2.3%	12	3.5%	7	3.4%	9	4.1%	9	2.1%	3	1.1%	0	0.0%	59	2.7%
女性	3	1.9%	8	3.2%	7	1.9%	11	2.2%	15	2.3%	11	2.7%	15	3.5%	21	2.5%	8	1.7%	1	0.9%	100	2.4%
男女合計	3	1.9%	8	3.2%	7	1.9%	11	2.2%	15	2.3%	11	2.7%	15	3.5%	21	2.5%	8	1.7%	1	0.9%	100	2.4%
5 个回答	37	45.1%	81	65.9%	142	74.0%	160	67.2%	207	66.3%	130	66.3%	138	65.4%	265	61.3%	94	50.3%	24	55.8%	1278	63.4%
男性	40	54.1%	78	62.4%	129	70.5%	172	65.2%	227	65.6%	135	64.9%	134	60.6%	224	52.7%	119	43.0%	36	49.3%	1294	58.9%
女性	77	49.4%	159	64.1%	271	72.3%	332	66.1%	434	66.0%	265	65.6%	272	63.0%	489	57.1%	213	45.9%	60	51.7%	2572	61.1%
男女合計	77	49.4%	159	64.1%	271	72.3%	332	66.1%	434	66.0%	265	65.6%	272	63.0%	489	57.1%	213	45.9%	60	51.7%	2572	61.1%
6 个回答	8	9.8%	14	11.4%	13	6.8%	21	8.8%	23	7.4%	7	3.6%	10	4.7%	43	10.0%	20	10.7%	8	18.6%	167	8.3%
男性	13	17.6%	10	8.0%	11	6.0%	23	8.7%	24	6.9%	19	9.1%	17	7.7%	50	11.8%	43	15.5%	17	23.3%	227	10.3%
女性	21	13.5%	24	9.7%	24	6.4%	44	8.8%	47	7.1%	26	6.4%	27	6.3%	93	10.9%	63	13.6%	25	21.6%	394	9.4%
男女合計	21	13.5%	24	9.7%	24	6.4%	44	8.8%	47	7.1%	26	6.4%	27	6.3%	93	10.9%	63	13.6%	25	21.6%	394	9.4%
無 回答	23	28.0%	6	4.9%	15	7.8%	21	8.8%	40	12.8%	31	15.8%	38	18.0%	82	19.0%	54	28.9%	10	23.3%	320	15.9%
男性	10	13.5%	7	5.6%	7	3.8%	18	6.8%	27	7.8%	12	5.8%	27	12.2%	96	22.6%	96	34.7%	12	16.4%	312	14.2%
女性	33	21.2%	13	5.2%	22	5.9%	39	7.8%	67	10.2%	43	10.6%	65	15.0%	178	20.8%	150	32.3%	22	19.0%	632	15.0%
男女合計	33	21.2%	13	5.2%	22	5.9%	39	7.8%	67	10.2%	43	10.6%	65	15.0%	178	20.8%	150	32.3%	22	19.0%	632	15.0%
全体(人)	82		123		192		238		312		196		211		432		187		43		2016	
男性	74		125		183		264		346		208		221		425		277		73		2196	
女性	74		125		183		264		346		208		221		425		277		73		2196	
男女合計	156		248		375		502		658		404		432		857		464		116		4212	

○職 場

	10	割合	20	割合	30	割合	40	割合	50	割合	64	割合	69	割合	70	割合	80	割合	90	割合	全体数	割合
1 个回答	1	1.2%	21	17.1%	36	18.8%	60	25.2%	60	19.2%	26	13.3%	17	8.1%	17	3.9%	0	0.0%	0	0.0%	238	11.8%
男性	0	0.0%	8	6.4%	13	7.1%	13	4.9%	11	3.2%	6	2.9%	1	0.5%	1	0.2%	0	0.0%	0	0.0%	53	2.4%
女性	1	0.6%	29	11.7%	49	13.1%	73	14.5%	71	10.8%	32	7.9%	18	4.2%	18	2.1%	0	0.0%	0	0.0%	291	6.9%
男女合計	1	0.6%	29	11.7%	49	13.1%	73	14.5%	71	10.8%	32	7.9%	18	4.2%	18	2.1%	0	0.0%	0	0.0%	291	6.9%
2 个回答	1	1.2%	8	6.5%	23	12.0%	23	9.7%	31	9.9%	19	9.7%	11	5.2%	5	1.2%	0	0.0%	0	0.0%	121	6.0%
男性	2	2.7%	4	3.2%	4	2.2%	11	4.2%	12	3.5%	3	1.4%	2	0.9%	2	0.5%	1	0.4%	0	0.0%	41	1.9%
女性	3	1.9%	12	4.8%	27	7.2%	34	6.8%	43	6.5%	22	5.4%	13	3.0%	7	0.8%	1	0.2%	0	0.0%	162	3.8%
男女合計	3	1.9%	12	4.8%	27	7.2%	34	6.8%	43	6.5%	22	5.4%	13	3.0%	7	0.8%	1	0.2%	0	0.0%	162	3.8%
3 个回答	0	0.0%	4	3.3%	8	4.2%	16	6.7%	11	3.5%	3	1.5%	7	3.3%	8	1.9%	0	0.0%	0	0.0%	57	2.8%
男性	0	0.0%	6	4.8%	0	0.0%	4	1.5%	5	1.4%	2	1.0%	4	1.8%	2	0.5%	0	0.0%	0	0.0%	23	1.0%
女性	0	0.0%	10	4.0%	8	2.1%	20	4.0%	16	2.4%	5	1.2%	11	2.5%	10	1.2%	0	0.0%	0	0.0%	80	1.9%
男女合計	0	0.0%	10	4.0%	8	2.1%	20	4.0%	16	2.4%	5	1.2%	11	2.5%	10	1.2%	0	0.0%	0	0.0%	80	1.9%
4 个回答	0	0.0%	4	3.3%	7	3.6%	7	2.9%	8	2.6%	4	2.0%	13	6.2%	9	2.1%	0	0.0%	0	0.0%	52	2.6%
男性	1	1.4%	4	3.2%	8	4.4%	9	3.4%	3	0.9%	4	1.9%	4	1.8%	0	0.0%	1	0.4%	0	0.0%	34	1.5%
女性	1	0.6%	8	3.2%	15	4.0%	16	3.2%	11	1.7%	8	2.0%	17	3.9%	9	1.1%	1	0.2%	0	0.0%	86	2.0%
男女合計	1	0.6%	8	3.2%	15	4.0%	16	3.2%	11	1.7%	8	2.0%	17	3.9%	9	1.1%	1	0.2%	0	0.0%	86	2.0%
5 个回答	17	20.7%	48	39.0%	87	45.3%	91	38.2%	138	44.2%	89	45.4%	65	30.8%	116	26.9%	32	17.1%	9	20.9%	692	34.3%
男性	25	33.8%	62	49.6%	108	59.0%	148	56.1%	189	54.6%	95	45.7%	78	35.3%	105	24.7%	31	11.2%	8	11.0%	849	38.7%
女性	42	26.9%	110	44.4%	195	52.0%	239	47.6%	327	49.7%	184	45.5%	143	33.1%	221	25.8%	63	13.6%	17	14.7%	1541	36.6%
男女合計	42	26.9%	110	44.4%	195	52.0%	239	47.6%	327	49.7%	184	45.5%	143	33.1%	221	25.8%	63	13.6%	17	14.7%	1541	36.6%
6 个回答	30	36.6%	22	17.9%	23	12.0%	26	10.9%	41	13.1%	32	16.3%	59	28.0%	139	32.2%	54	28.9%	15	34.9%	441	21.9%
男性	30	40.5%	30	24.0%	38	20.8%	59	22.3%	90	26.0%	74	35.6%	74	33.5%	146	34.4%	93	33.6%	44	60.3%	678	30.9%
女性	60	38.5%	52	21.0%	61	16.3%	85	16.9%	131	19.9%	106	26.2%	133	30.8%	285	33.3%	147	31.7%	59	50.9%	1119	26.6%
男女合計	60	38.5%	52	21.0%	61	16.3%	85	16.9%	131	19.9%	106	26.2%	133	30.8%	285	33.3%	147	31.7%	59	50.9%	1119	26.6%
無 回答	33	40.2%	16	13.0%	8	4.2%	15	6.3%	23	7.4%	23	11.7%	39	18.5%	138	31.9%	101	54.0%	19	44.2%	415	20.6%
男性	16	21.6%	11	8.8%	12	6.6%	20	7.6%	36	10.4%	24	11.5%	58	26.2%	169	39.8%	151	54.5%	21	28.8%	518	23.6%
女性	49	31.4%	27	10.9%	20	5.3%	35	7.0%	59	9.0%	47	11.6%	97	22.5%	307	35.8%	252	54.3%	40	34.5%	933	22.2%
男女合計	49	31.4%	27	10.9%	20	5.3%	35	7.0%	59	9.0%	47	11.6%	97	22.5%	307	35.8%	252	54.3%	40	34.5%	933	22.2%
全体(人)	82		123		192		238		312		196		211		432		187		43		2016	
男性	74		125		183		264		346		208		221		425		277		73		2196	
女性	74		125		183		264		346		208		221									

○飲食店

	10	割合	20	割合	30	割合	40	割合	50	割合	64	割合	69	割合	70	割合	80	割合	90	割合	全体数	割合
1と回答	0	0.0%	0	0.0%	0	0.0%	2	0.8%	1	0.3%	1	0.5%	1	0.5%	1	0.2%	1	0.5%	0	0.0%	7	0.3%
男性	0	0.0%	0	0.0%	2	1.1%	1	0.4%	0	0.0%	0	0.0%	1	0.5%	0	0.0%	0	0.0%	0	0.0%	4	0.2%
女性	0	0.0%	0	0.0%	2	0.5%	3	0.6%	1	0.2%	1	0.2%	2	0.5%	1	0.1%	1	0.2%	0	0.0%	11	0.3%
男女合計	0	0.0%	0	0.0%	2	0.5%	3	0.6%	1	0.2%	1	0.2%	2	0.5%	1	0.1%	1	0.2%	0	0.0%	11	0.3%
2と回答	1	1.2%	0	0.0%	2	1.0%	3	1.3%	5	1.6%	2	1.0%	1	0.5%	1	0.2%	0	0.0%	0	0.0%	15	0.7%
男性	0	0.0%	2	1.6%	0	0.0%	1	0.4%	2	0.6%	1	0.5%	2	0.9%	0	0.0%	0	0.0%	0	0.0%	8	0.4%
女性	1	0.6%	2	0.8%	2	0.5%	4	0.8%	7	1.1%	3	0.7%	3	0.7%	1	0.1%	0	0.0%	0	0.0%	23	0.5%
男女合計	1	0.6%	2	0.8%	2	0.5%	4	0.8%	7	1.1%	3	0.7%	3	0.7%	1	0.1%	0	0.0%	0	0.0%	23	0.5%
3と回答	0	0.0%	6	4.9%	10	5.2%	5	2.1%	8	2.6%	5	2.6%	2	0.9%	3	0.7%	2	1.1%	0	0.0%	41	2.0%
男性	1	1.4%	4	3.2%	0	0.0%	0	0.0%	5	1.4%	4	1.9%	2	0.9%	1	0.2%	3	1.1%	0	0.0%	20	0.9%
女性	1	0.6%	10	4.0%	10	2.7%	5	1.0%	13	2.0%	9	2.2%	4	0.9%	4	0.5%	5	1.1%	0	0.0%	61	1.4%
男女合計	1	0.6%	10	4.0%	10	2.7%	5	1.0%	13	2.0%	9	2.2%	4	0.9%	4	0.5%	5	1.1%	0	0.0%	61	1.4%
4と回答	3	3.7%	18	14.6%	12	6.3%	24	10.1%	27	8.7%	18	9.2%	22	10.4%	23	5.3%	8	4.3%	0	0.0%	155	7.7%
男性	2	2.7%	14	11.2%	16	8.7%	16	6.1%	10	2.9%	7	3.4%	8	3.6%	8	1.9%	2	0.7%	1	1.4%	84	3.8%
女性	5	3.2%	32	12.9%	28	7.5%	40	8.0%	37	5.6%	25	6.2%	30	6.9%	31	3.6%	10	2.2%	1	0.9%	239	5.7%
男女合計	5	3.2%	32	12.9%	28	7.5%	40	8.0%	37	5.6%	25	6.2%	30	6.9%	31	3.6%	10	2.2%	1	0.9%	239	5.7%
5と回答	30	36.6%	55	44.7%	92	47.9%	108	45.4%	127	40.7%	76	38.8%	68	32.2%	148	34.3%	39	20.9%	8	18.6%	751	37.3%
男性	35	47.3%	60	48.0%	120	65.6%	143	54.2%	169	48.8%	99	47.6%	90	40.7%	137	32.2%	51	18.4%	9	12.3%	913	41.6%
女性	65	41.7%	115	46.4%	212	56.5%	251	50.0%	296	45.0%	175	43.3%	158	36.6%	285	33.3%	90	19.4%	17	14.7%	1664	39.5%
男女合計	65	41.7%	115	46.4%	212	56.5%	251	50.0%	296	45.0%	175	43.3%	158	36.6%	285	33.3%	90	19.4%	17	14.7%	1664	39.5%
6と回答	20	24.4%	32	26.0%	52	27.1%	64	26.9%	88	28.2%	54	27.6%	62	29.4%	116	26.9%	48	25.7%	13	30.2%	549	27.2%
男性	24	32.4%	33	26.4%	31	16.9%	78	29.5%	111	32.1%	67	32.2%	60	27.1%	125	29.4%	75	27.1%	40	54.8%	644	29.3%
女性	44	28.2%	65	26.2%	83	22.1%	142	28.3%	199	30.2%	121	30.0%	122	28.2%	241	28.1%	123	26.5%	53	45.7%	1193	28.3%
男女合計	44	28.2%	65	26.2%	83	22.1%	142	28.3%	199	30.2%	121	30.0%	122	28.2%	241	28.1%	123	26.5%	53	45.7%	1193	28.3%
無回答	28	34.1%	12	9.8%	24	12.5%	32	13.4%	56	17.9%	40	20.4%	55	26.1%	140	32.4%	89	47.6%	22	51.2%	498	24.7%
男性	12	16.2%	12	9.6%	14	7.7%	25	9.5%	49	14.2%	30	14.4%	58	26.2%	154	36.2%	146	52.7%	23	31.5%	523	23.8%
女性	40	25.6%	24	9.7%	38	10.1%	57	11.4%	105	16.0%	70	17.3%	113	26.2%	294	34.3%	235	50.6%	45	38.8%	1021	24.2%
男女合計	40	25.6%	24	9.7%	38	10.1%	57	11.4%	105	16.0%	70	17.3%	113	26.2%	294	34.3%	235	50.6%	45	38.8%	1021	24.2%
全体(人)	82		123		192		238		312		196		211		432		187		43		2016	
男性	74		125		183		264		346		208		221		425		277		73		2196	
女性	156		248		375		502		658		404		432		857		464		116		4212	
男女合計	156		248		375		502		658		404		432		857		464		116		4212	

○遊技場

	10	割合	20	割合	30	割合	40	割合	50	割合	64	割合	69	割合	70	割合	80	割合	90	割合	全体数	割合
1と回答	0	0.0%	0	0.0%	1	0.5%	1	0.4%	0	0.0%	3	1.5%	1	0.5%	1	0.2%	1	0.5%	0	0.0%	8	0.4%
男性	0	0.0%	0	0.0%	1	0.5%	0	0.0%	0	0.0%	0	0.0%	1	0.5%	1	0.2%	0	0.0%	0	0.0%	3	0.1%
女性	0	0.0%	0	0.0%	2	0.5%	1	0.2%	0	0.0%	3	0.7%	2	0.5%	2	0.2%	1	0.2%	0	0.0%	11	0.3%
男女合計	0	0.0%	0	0.0%	2	0.5%	1	0.2%	0	0.0%	3	0.7%	2	0.5%	2	0.2%	1	0.2%	0	0.0%	11	0.3%
2と回答	0	0.0%	1	0.8%	3	1.6%	1	0.4%	3	1.0%	2	1.0%	3	1.4%	7	1.6%	1	0.5%	1	2.3%	22	1.1%
男性	1	1.4%	0	0.0%	0	0.0%	0	0.0%	1	0.3%	1	0.5%	0	0.0%	2	0.5%	0	0.0%	0	0.0%	5	0.2%
女性	1	0.6%	1	0.4%	3	0.8%	1	0.2%	4	0.6%	3	0.7%	3	0.7%	9	1.1%	1	0.2%	1	0.9%	27	0.6%
男女合計	1	0.6%	1	0.4%	3	0.8%	1	0.2%	4	0.6%	3	0.7%	3	0.7%	9	1.1%	1	0.2%	1	0.9%	27	0.6%
3と回答	0	0.0%	2	1.6%	5	2.6%	3	1.3%	6	1.9%	5	2.6%	4	1.9%	3	0.7%	1	0.5%	0	0.0%	29	1.4%
男性	0	0.0%	0	0.0%	0	0.0%	1	0.4%	2	0.6%	0	0.0%	0	0.0%	1	0.2%	0	0.0%	0	0.0%	4	0.2%
女性	0	0.0%	2	0.8%	5	1.3%	4	0.8%	8	1.2%	5	1.2%	4	0.9%	4	0.5%	1	0.2%	0	0.0%	33	0.8%
男女合計	0	0.0%	2	0.8%	5	1.3%	4	0.8%	8	1.2%	5	1.2%	4	0.9%	4	0.5%	1	0.2%	0	0.0%	33	0.8%
4と回答	1	1.2%	7	5.7%	4	2.1%	9	3.8%	7	2.2%	7	3.6%	2	0.9%	9	2.1%	0	0.0%	0	0.0%	46	2.3%
男性	1	1.4%	2	1.6%	4	2.2%	3	1.1%	3	0.9%	1	0.5%	1	0.5%	1	0.2%	0	0.0%	0	0.0%	16	0.7%
女性	2	1.3%	9	3.6%	8	2.1%	12	2.4%	10	1.5%	8	2.0%	3	0.7%	10	1.2%	0	0.0%	0	0.0%	62	1.7%
男女合計	2	1.3%	9	3.6%	8	2.1%	12	2.4%	10	1.5%	8	2.0%	3	0.7%	10	1.2%	0	0.0%	0	0.0%	62	1.7%
5と回答	16	19.5%	33	26.8%	61	31.8%	55	23.1%	68	21.8%	42	21.4%	28	13.3%	78	18.1%	26	13.9%	8	18.6%	415	20.6%
男性	28	37.8%	34	27.2%	64	35.0%	65	24.6%	72	20.8%	33	15.9%	45	20.4%	83	19.5%	26	9.4%	6	8.2%	456	20.8%
女性	44	28.2%	67	27.0%	125	33.3%	120	23.9%	140	21.3%	75	18.6%	73	16.9%	161	18.8%	52	11.2%	14	12.1%	871	20.7%
男女合計	44	28.2%	67	27.0%	125	33.3%	120	23.9%	140	21.3%	75	18.6%	73	16.9%	161	18.8%	52	11.2%	14	12.1%	871	20.7%
6と回答	38	46.3%	67	54.5%	94	49.0%	134	56.3%	171	54.8%	93	47.4%	114	54.0%	175	40.5%	67	35.8%	15	34.9%	968	48.0%
男性	33	44.6%	76	60.8%	100	54.6%	165	62.5%	209	60.4%	135	64.9%	108	48.9%	171	40.2%	102	36.8%	45	61.6%	1144	52.1%
女性	71	45.5%	143	57.7%	194	51.7%	299	59.6%	380	57.8%	228	56.4%	222	51.4%	346	40.4%	169	36.4%	60	51.7%	2112	50.1%
男女合計	71	45.5%	143	57.7%	194	51.7%	299	59.6%	380	57.8%	228	56.4%	222	51.4%	346	40.4%	169	36.4%	60	51.7%	2112	50.1%
無回答	27	32.9%	13	10.6%	24	12.5%	35	14.7%	57	18.3%	44	22.4%	59	28.0%	159	36.8%	91	48.7%	19	44.2%	528	26.2%
男性	11	14.9%	13	10.4%	14	7.7%	30	11.4%	59	17.1%	38	18.3%	66	29.9%	166	39.1%	149	53.8%	22	30.1%	568	25.9%
女性	38	24.4%	26	10.5%	38	10.1%	65	12.9%	116	17.6%	82	20.3%	125	28.9%	325	37.9%	240	51.7%	41	35.3%	1096	26.0%</

○医療機関

	10	割合	20	割合	30	割合	40	割合	50	割合	64	割合	69	割合	70	割合	80	割合	90	割合	全体数	割合
1と回答	0	0.0%	0	0.0%	0	0.0%	1	0.4%	0	0.0%	0	0.0%	0	0.0%	1	0.2%	0	0.0%	0	0.0%	2	0.1%
男性	0	0.0%	0	0.0%	1	0.5%	0	0.0%	0	0.0%	0	0.0%	0	0.0%	0	0.0%	0	0.0%	0	0.0%	1	0.0%
女性	0	0.0%	0	0.0%	1	0.3%	1	0.2%	0	0.0%	0	0.0%	0	0.0%	1	0.1%	0	0.0%	0	0.0%	1	0.0%
男女合計	0	0.0%	0	0.0%	1	0.3%	1	0.2%	0	0.0%	0	0.0%	0	0.0%	1	0.1%	0	0.0%	0	0.0%	2	0.1%
2と回答	0	0.0%	0	0.0%	1	0.5%	0	0.0%	0	0.0%	0	0.0%	0	0.0%	0	0.0%	0	0.0%	0	0.0%	1	0.0%
男性	0	0.0%	0	0.0%	0	0.0%	0	0.0%	0	0.0%	0	0.0%	0	0.0%	0	0.0%	0	0.0%	0	0.0%	0	0.0%
女性	0	0.0%	0	0.0%	1	0.3%	0	0.0%	0	0.0%	0	0.0%	0	0.0%	0	0.0%	1	0.2%	0	0.0%	0	0.0%
男女合計	0	0.0%	0	0.0%	1	0.3%	0	0.0%	0	0.0%	0	0.0%	0	0.0%	0	0.0%	1	0.1%	0	0.0%	0	0.0%
3と回答	0	0.0%	0	0.0%	0	0.0%	0	0.0%	0	0.0%	0	0.0%	0	0.0%	1	0.2%	0	0.0%	0	0.0%	1	0.0%
男性	0	0.0%	0	0.0%	0	0.0%	0	0.0%	0	0.0%	0	0.0%	0	0.0%	1	0.2%	0	0.0%	0	0.0%	0	0.0%
女性	0	0.0%	0	0.0%	0	0.0%	1	0.4%	0	0.0%	2	1.0%	0	0.0%	1	0.2%	1	0.4%	0	0.0%	5	0.2%
男女合計	0	0.0%	0	0.0%	0	0.0%	1	0.2%	0	0.0%	2	0.5%	0	0.0%	2	0.2%	1	0.2%	0	0.0%	6	0.1%
4と回答	0	0.0%	0	0.0%	2	1.0%	1	0.4%	2	0.6%	4	2.0%	4	1.9%	8	1.9%	10	5.3%	3	7.0%	34	1.7%
男性	2	2.7%	0	0.0%	2	1.1%	3	0.8%	3	0.9%	3	1.4%	3	1.4%	14	3.3%	11	4.0%	22	30.1%	40	1.8%
女性	2	1.3%	0	0.0%	4	1.1%	3	0.6%	5	0.8%	7	1.7%	7	1.6%	22	2.6%	21	4.5%	3	2.6%	74	1.8%
男女合計	2	1.3%	0	0.0%	4	1.1%	3	0.6%	5	0.8%	7	1.7%	7	1.6%	22	2.6%	21	4.5%	3	2.6%	74	1.8%
5と回答	23	28.0%	56	45.5%	92	47.9%	107	45.0%	162	51.9%	109	55.6%	110	52.1%	222	51.4%	67	35.8%	14	32.6%	962	47.7%
男性	35	47.3%	75	60.0%	125	68.3%	157	59.5%	201	58.1%	118	56.7%	115	52.0%	186	43.8%	83	30.0%	29	39.7%	1124	51.2%
女性	25	33.8%	37	29.6%	42	23.0%	78	29.5%	96	27.7%	54	26.0%	43	19.5%	67	15.8%	43	15.5%	22	30.1%	507	23.1%
男女合計	58	37.2%	131	52.8%	217	57.9%	264	52.6%	363	55.2%	227	56.2%	225	52.1%	408	47.6%	150	32.3%	43	37.1%	2086	49.5%
6と回答	31	37.8%	53	43.1%	73	38.0%	93	39.1%	91	29.2%	36	18.4%	37	17.5%	61	14.1%	24	12.8%	5	11.6%	504	25.0%
男性	25	33.8%	37	29.6%	42	23.0%	78	29.5%	96	27.7%	54	26.0%	43	19.5%	67	15.8%	43	15.5%	22	30.1%	40	1.8%
女性	56	35.9%	90	36.3%	115	30.7%	171	34.1%	187	28.4%	90	22.3%	80	18.5%	128	14.9%	67	14.4%	27	23.3%	1011	24.0%
男女合計	56	35.9%	90	36.3%	115	30.7%	171	34.1%	187	28.4%	90	22.3%	80	18.5%	128	14.9%	67	14.4%	27	23.3%	1011	24.0%
無回答	28	34.1%	14	11.4%	24	12.5%	36	15.1%	57	18.3%	47	24.0%	60	28.4%	139	32.2%	86	46.0%	21	48.8%	512	25.4%
男性	12	16.2%	13	10.4%	13	7.1%	26	9.8%	46	13.3%	31	14.9%	60	27.1%	156	36.7%	139	50.2%	22	30.1%	40	1.8%
女性	40	25.6%	27	10.9%	37	9.9%	62	12.4%	103	15.7%	78	19.3%	120	27.8%	295	34.4%	225	48.5%	43	37.1%	1030	24.5%
男女合計	40	25.6%	27	10.9%	37	9.9%	62	12.4%	103	15.7%	78	19.3%	120	27.8%	295	34.4%	225	48.5%	43	37.1%	1030	24.5%
全体(人)	82		123		192		238		312		196		211		432		187		43		2016	
男性	74		125		183		264		346		208		221		425		277		73		2196	
女性	156		248		375		502		658		404		432		857		464		116		4212	

○公共交通機関

	10	割合	20	割合	30	割合	40	割合	50	割合	64	割合	69	割合	70	割合	80	割合	90	割合	全体数	割合
1と回答	0	0.0%	0	0.0%	0	0.0%	0	0.0%	0	0.0%	1	0.5%	0	0.0%	0	0.0%	0	0.0%	0	0.0%	1	0.0%
男性	1	1.4%	0	0.0%	1	0.5%	0	0.0%	1	0.3%	0	0.0%	0	0.0%	0	0.0%	1	0.4%	0	0.0%	4	0.2%
女性	1	0.6%	0	0.0%	1	0.3%	0	0.0%	1	0.2%	1	0.2%	0	0.0%	0	0.0%	1	0.2%	0	0.0%	5	0.1%
男女合計	1	0.6%	0	0.0%	1	0.3%	0	0.0%	1	0.2%	1	0.2%	0	0.0%	0	0.0%	1	0.2%	0	0.0%	5	0.1%
2と回答	0	0.0%	0	0.0%	1	0.5%	1	0.4%	1	0.3%	0	0.0%	0	0.0%	1	0.2%	0	0.0%	0	0.0%	4	0.2%
男性	0	0.0%	1	0.8%	0	0.0%	0	0.0%	0	0.0%	0	0.0%	0	0.0%	2	0.5%	0	0.0%	0	0.0%	3	0.1%
女性	0	0.0%	1	0.4%	1	0.3%	1	0.2%	1	0.2%	0	0.0%	0	0.0%	3	0.4%	0	0.0%	0	0.0%	7	0.2%
男女合計	0	0.0%	1	0.4%	1	0.3%	1	0.2%	1	0.2%	0	0.0%	0	0.0%	3	0.4%	0	0.0%	0	0.0%	7	0.2%
3と回答	0	0.0%	0	0.0%	1	0.5%	3	1.3%	1	0.3%	0	0.0%	0	0.0%	0	0.0%	0	0.0%	0	0.0%	5	0.2%
男性	2	2.7%	0	0.0%	0	0.0%	1	0.4%	0	0.0%	1	0.5%	0	0.0%	1	0.2%	0	0.0%	0	0.0%	5	0.2%
女性	2	1.3%	0	0.0%	1	0.3%	4	0.8%	1	0.2%	1	0.2%	0	0.0%	1	0.1%	0	0.0%	0	0.0%	10	0.2%
男女合計	2	1.3%	0	0.0%	1	0.3%	4	0.8%	1	0.2%	1	0.2%	0	0.0%	1	0.1%	0	0.0%	0	0.0%	10	0.2%
4と回答	3	3.7%	2	1.6%	5	2.6%	4	1.7%	0	0.0%	0	0.0%	2	0.9%	0	0.0%	2	1.1%	0	0.0%	18	0.9%
男性	4	5.4%	2	1.6%	4	2.2%	2	0.8%	4	1.2%	0	0.0%	0	0.0%	2	0.5%	0	0.0%	0	0.0%	18	0.8%
女性	7	4.5%	4	1.6%	9	2.4%	6	1.2%	4	0.6%	0	0.0%	2	0.5%	2	0.2%	2	0.4%	0	0.0%	36	0.9%
男女合計	7	4.5%	4	1.6%	9	2.4%	6	1.2%	4	0.6%	0	0.0%	2	0.5%	2	0.2%	2	0.4%	0	0.0%	36	0.9%
5と回答	28	34.1%	53	43.1%	74	38.5%	80	33.6%	116	37.2%	65	33.2%	50	23.7%	131	30.3%	43	23.0%	12	27.9%	652	32.3%
男性	35	47.3%	58	46.4%	82	44.8%	101	38.3%	123	35.5%	68	32.7%	80	36.2%	127	29.9%	42	15.2%	10	13.7%	726	33.1%
女性	63	40.4%	111	44.8%	156	41.6%	181	36.1%	239	36.3%	133	32.9%	130	30.1%	258	50.1%	85	18.3%	22	19.0%	1378	32.7%
男女合計	24	29.3%	54	43.9%	88	45.8%	113	47.5%	134	42.9%	82	41.8%	98	46.4%	143	33.1%	48	25.7%	9	20.9%	793	39.3%
男性	21	28.4%	51	40.8%	80	43.7%	133	50.4%	167	48.3%	102	49.0%	81	36.7%	130	30.6%	86	31.0%	41	56.2%	892	40.6%
女性	45	28.8%	105	42.3%	168	44.8%	246	49.0%	301	45.7%	184	45.5%	179	41.4%	273	31.9%	134	28.9%	50	43.1%	1685	40.0%
男女合計	45	28.8%	105	42.3%	168	44.8%	246	49.0%	301	45.7%	184	45.5%	179	41.4%	273	31.9%	134	28.9%	50	43.1%	1685	40.0%
無回答	27	32.9%	14	11.4%	23	12.0%	37	15.5%	60	19.2%	48	24.5%	61	28.9%	157	36.3%	94	50.3%	22	51.2%	543	26.9%
男性	11	14.9%	13	10.4%	16	8.7%	27	10.2%	51	14.7%	37	17.8%	60	27.1%	163	38.4%	148	53.4%	22	30.1%	548	25.0%
女性	38	24.4%	27	10.9%	39	10.4%	64	12.7%	111	16.9%	85	21.0%	121	28.0%	320	37.3%	242	52.2%	44	37.9%	1091	25.9%
男女合計	38	24.4%	27	10.9%	39	10.4%	64	12.7%	111	16.9%	85	21.0%	121	28.0%	320	37.3%	242	52.2%	44	37.9%	1091	25.9%
全体(人)	82		123		192		238		312		196		211		432		187		43		2016	
男性	74		125		183		264		346		208		221		425		277		73		2196	
女性	156		248		375		502		658		404		432		857		464		116		4212	

○路上

	10	割合	20	割合	30	割合	40	割合	50	割合	64	割合	69	割合	70	割合	80	割合	90	割合	全体数	割合
1と回答	0	0.0%	1	0.8%	2	1.0%	1	0.4%	2	0.6%	3	1.5%	2	0.9%	3	0.7%	2	1.1%				

○子供が利用する屋外の空間

	10	割合	20	割合	30	割合	40	割合	50	割合	64	割合	69	割合	70	割合	80	割合	90	割合	全体数	割合
1と回答																						
男性	0	0.0%	1	0.8%	0	0.0%	0	0.0%	1	0.3%	0	0.0%	0	0.0%	0	0.0%	1	0.5%	0	0.0%	3	0.1%
女性	0	0.0%	0	0.0%	1	0.5%	0	0.0%	0	0.0%	0	0.0%	0	0.0%	0	0.0%	0	0.0%	0	0.0%	1	0.0%
男女合計	0	0.0%	1	0.4%	1	0.3%	0	0.0%	1	0.2%	0	0.0%	0	0.0%	0	0.0%	1	0.2%	0	0.0%	4	0.1%
2と回答																						
男性	0	0.0%	0	0.0%	1	0.5%	0	0.0%	0	0.0%	1	0.5%	0	0.0%	2	0.5%	0	0.0%	0	0.0%	4	0.2%
女性	0	0.0%	0	0.0%	0	0.0%	2	0.8%	0	0.0%	0	0.0%	0	0.0%	0	0.0%	1	0.2%	0	0.0%	1	1.4%
男女合計	0	0.0%	0	0.0%	1	0.3%	2	0.4%	0	0.0%	1	0.2%	0	0.0%	3	0.4%	0	0.0%	1	0.9%	8	0.2%
3と回答																						
男性	0	0.0%	0	0.0%	1	0.5%	2	0.8%	1	0.3%	0	0.0%	1	0.5%	1	0.2%	0	0.0%	0	0.0%	6	0.3%
女性	1	1.4%	1	0.8%	4	2.2%	0	0.0%	0	0.0%	2	1.0%	0	0.0%	0	0.0%	0	0.0%	0	0.0%	8	0.4%
男女合計	1	0.6%	1	0.4%	5	1.3%	2	0.4%	1	0.2%	2	0.5%	1	0.2%	1	0.1%	0	0.0%	0	0.0%	14	0.3%
4と回答																						
男性	4	4.9%	1	0.8%	1	0.5%	2	0.8%	1	0.3%	0	0.0%	3	1.4%	2	0.5%	2	1.1%	0	0.0%	16	0.8%
女性	1	1.4%	0	0.0%	5	2.7%	4	1.5%	1	0.3%	1	0.5%	0	0.0%	0	0.0%	1	0.4%	0	0.0%	13	0.6%
男女合計	5	3.2%	1	0.4%	6	1.6%	6	1.2%	2	0.3%	1	0.2%	3	0.7%	2	0.2%	3	0.6%	0	0.0%	29	0.7%
5と回答																						
男性	20	24.4%	45	36.6%	86	44.8%	96	40.3%	89	28.5%	49	25.0%	47	22.3%	117	27.1%	36	19.3%	9	20.9%	594	29.5%
女性	29	39.2%	46	36.8%	81	44.3%	110	41.7%	107	30.9%	52	25.0%	64	29.0%	111	26.1%	31	11.2%	7	9.6%	638	29.1%
男女合計	49	31.4%	91	36.7%	167	44.5%	206	41.0%	196	29.8%	101	25.0%	111	25.7%	228	26.6%	67	14.4%	16	13.8%	1232	29.2%
6と回答																						
男性	31	37.8%	63	51.2%	78	40.6%	100	42.0%	161	51.6%	98	50.0%	94	44.5%	148	34.3%	54	28.9%	14	32.6%	841	41.7%
女性	32	43.2%	64	51.2%	76	41.5%	120	45.5%	182	52.6%	114	54.8%	92	41.6%	139	32.7%	91	32.9%	43	58.9%	953	43.4%
男女合計	63	40.4%	127	51.2%	154	41.1%	220	43.8%	343	52.1%	212	52.5%	186	43.1%	287	33.5%	145	31.3%	57	49.1%	1794	42.6%
無回答																						
男性	27	32.9%	13	10.6%	25	13.0%	38	16.0%	59	18.9%	48	24.5%	66	31.3%	162	37.5%	94	50.3%	20	46.5%	552	27.4%
女性	11	14.9%	14	11.2%	16	8.7%	28	10.6%	56	16.2%	39	18.8%	65	29.4%	174	40.9%	154	55.6%	22	30.1%	579	26.4%
男女合計	38	24.4%	27	10.9%	41	10.9%	66	13.1%	115	17.5%	87	21.5%	131	30.3%	336	39.2%	248	53.4%	42	36.2%	1131	26.9%
全体(人)																						
男性	82		123		192		238		312		196		211		432		187		43		2016	
女性	74		125		183		264		346		208		221		425		277		73		2196	
男女合計	156		248		375		502		658		404		432		857		464		116		4212	

○健康増進施設

	10	割合	20	割合	30	割合	40	割合	50	割合	64	割合	69	割合	70	割合	80	割合	90	割合	全体数	割合
1と回答																						
男性	0	0.0%	0	0.0%	0	0.0%	0	0.0%	0	0.0%	0	0.0%	0	0.0%	1	0.2%	0	0.0%	0	0.0%	1	0.0%
女性	0	0.0%	0	0.0%	1	0.5%	0	0.0%	1	0.3%	0	0.0%	0	0.0%	0	0.0%	0	0.0%	0	0.0%	2	0.1%
男女合計	0	0.0%	0	0.0%	1	0.3%	0	0.0%	1	0.2%	0	0.0%	0	0.0%	1	0.1%	0	0.0%	0	0.0%	3	0.1%
2と回答																						
男性	0	0.0%	0	0.0%	2	1.0%	0	0.0%	0	0.0%	0	0.0%	1	0.5%	0	0.0%	0	0.0%	0	0.0%	3	0.1%
女性	0	0.0%	0	0.0%	0	0.0%	1	0.4%	0	0.0%	0	0.0%	1	0.5%	0	0.0%	1	0.4%	0	0.0%	3	0.1%
男女合計	0	0.0%	0	0.0%	2	0.5%	1	0.2%	0	0.0%	0	0.0%	2	0.5%	0	0.0%	1	0.2%	0	0.0%	6	0.1%
3と回答																						
男性	0	0.0%	0	0.0%	0	0.0%	1	0.4%	0	0.0%	0	0.0%	0	0.0%	0	0.0%	0	0.0%	0	0.0%	1	0.0%
女性	0	0.0%	0	0.0%	0	0.0%	0	0.0%	0	0.0%	1	0.5%	0	0.0%	2	0.5%	0	0.0%	0	0.0%	4	0.2%
男女合計	0	0.0%	0	0.0%	0	0.0%	2	0.4%	0	0.0%	1	0.2%	0	0.0%	2	0.2%	0	0.0%	0	0.0%	5	0.1%
4と回答																						
男性	0	0.0%	1	0.8%	0	0.0%	0	0.0%	0	0.0%	0	0.0%	1	0.5%	0	0.0%	0	0.0%	0	0.0%	2	0.1%
女性	0	0.0%	0	0.0%	0	0.0%	0	0.0%	0	0.0%	0	0.0%	1	0.5%	0	0.0%	2	0.7%	0	0.0%	3	0.1%
男女合計	0	0.0%	1	0.4%	0	0.0%	0	0.0%	0	0.0%	0	0.0%	2	0.5%	0	0.0%	2	0.4%	0	0.0%	5	0.1%
5と回答																						
男性	19	23.2%	33	26.8%	64	33.3%	65	27.3%	73	23.4%	41	20.9%	37	17.5%	103	23.8%	38	20.3%	11	25.6%	484	24.0%
女性	25	33.8%	31	24.8%	58	31.7%	73	27.7%	89	25.7%	44	21.2%	61	27.6%	111	26.1%	35	12.6%	7	9.6%	534	24.3%
男女合計	44	28.2%	64	25.8%	122	32.5%	138	27.5%	162	24.6%	85	21.0%	98	22.7%	214	25.0%	73	15.7%	18	15.5%	1018	24.2%
6と回答																						
男性	35	42.7%	75	61.0%	100	52.1%	134	56.3%	180	57.7%	103	52.6%	105	49.8%	165	38.2%	53	28.3%	14	32.6%	964	47.8%
女性	37	50.0%	79	63.2%	106	57.9%	161	61.0%	199	57.5%	124	59.6%	91	41.2%	137	32.2%	86	31.0%	44	60.3%	1064	48.5%
男女合計	72	46.2%	154	62.1%	206	54.9%	295	58.8%	379	57.6%	227	56.2%	196	45.4%	302	35.2%	139	30.0%	58	50.0%	2028	48.1%
無回答																						
男性	28	34.1%	14	11.4%	26	13.5%	38	16.0%	59	18.9%	52	26.5%	67	31.8%	163	37.7%	96	51.3%	18	41.9%	561	27.8%
女性	12	16.2%	15	12.0%	18	9.8%	28	10.6%	57	16.5%	39	18.8%	67	30.3%	175	41.2%	153	55.2%	22	30.1%	586	26.7%
男女合計	40	25.6%	29	11.7%	44	11.7%	66	13.1%	116	17.6%	91	22.5%	134	31.0%	338	39.4%	249	53.7%	40	34.5%	1147	27.2%
全体(人)																						
男性	82		123		192		238		312		196		211		432		187		43		2016	
女性	74		125		183		264		346		208		221		425		277		73		2196	
男女合計	156		248		375		502		658		404		432		857		464		116		4212	

14 「COPD（慢性閉塞性肺疾患）」の認知度（調査票 問14）

問14 あなたは、「COPD（慢性閉塞性肺疾患）」という病気を知っていますか。

1 知っている 2 知らない

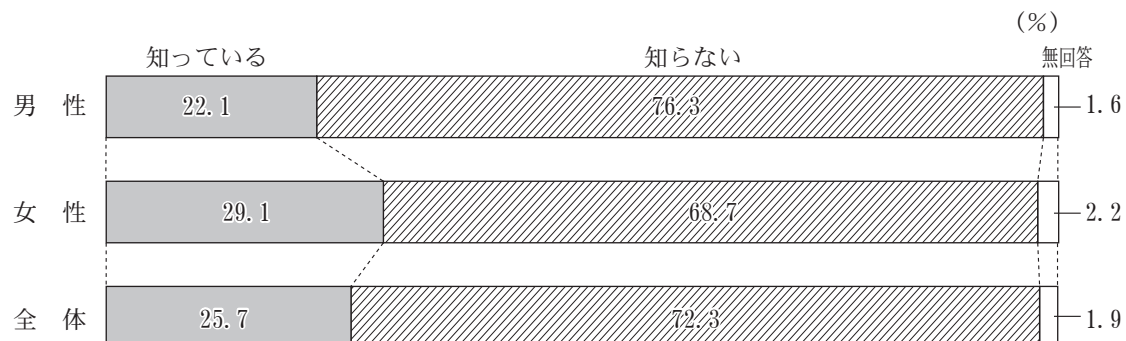

	10	割合	20	割合	30	割合	40	割合	50	割合	64	割合	69	割合	70	割合	80	割合	90	割合	全体数	割合
1と回答																						
男性	10	12.2%	26	21.1%	50	26.0%	68	28.6%	77	24.7%	40	20.4%	49	23.2%	93	21.5%	27	14.4%	6	14.0%	446	22.1%
女性	8	10.8%	37	29.6%	70	38.3%	94	35.6%	130	37.6%	71	34.1%	74	33.5%	99	23.3%	48	17.3%	7	9.6%	638	29.1%
男女合計	18	11.5%	63	25.4%	120	32.0%	162	32.3%	207	31.5%	111	27.5%	123	28.5%	192	22.4%	75	16.2%	13	11.2%	1084	25.7%
2と回答																						
男性	59	72.0%	97	78.9%	140	72.9%	168	70.6%	233	74.7%	155	79.1%	160	75.8%	334	77.3%	156	83.4%	36	83.7%	1538	76.3%
女性	62	83.8%	87	69.6%	113	61.7%	170	64.4%	215	62.1%	136	65.4%	144	65.2%	305	71.8%	213	76.9%	64	87.7%	1509	68.7%
男女合計	121	77.6%	184	74.2%	253	67.5%	338	67.3%	448	68.1%	291	72.0%	304	70.4%	639	74.6%	369	79.5%	100	86.2%	3047	72.3%
無回答																						
男性	13	15.9%	0	0.0%	2	1.0%	2	0.8%	2	0.6%	1	0.5%	2	0.9%	5	1.2%	4	2.1%	1	2.3%	32	1.6%
女性	4	5.4%	1	0.8%	0	0.0%	0	0.0%	1	0.3%	1	0.5%	3	1.4%	21	4.9%	16	5.8%	2	2.7%	49	2.2%
男女合計	17	10.9%	1	0.4%	2	0.5%	2	0.4%	3	0.5%	2	0.5%	5	1.2%	26	3.0%	20	4.3%	3	2.6%	81	1.9%
全体(人)																						
男性	82		123		192		238		312		196		211		432		187		43		2016	
女性	74		125		183		264		346		208		221		425		277		73		2196	
男女合計	156		248		375		502		658		404		432		857		464		116		4212	

県 北

	10	割合	20	割合	30	割合	40	割合	50	割合	64	割合	69	割合	70～	割合	全体数	割合
1と回答																		
男性	4	16.7%	11	23.4%	9	20.5%	17	29.8%	22	25.3%	7	14.3%	11	21.2%	25	17.7%	106	21.2%
女性	1	6.7%	16	35.6%	12	26.7%	27	39.1%	37	34.9%	18	40.9%	18	32.7%	37	19.6%	166	29.2%
男女合計	5	12.8%	27	29.3%	21	23.6%	44	34.9%	59	30.6%	25	26.9%	29	27.1%	62	18.8%	272	25.4%
2と回答																		
男性	16	66.7%	36	76.6%	35	79.5%	40	70.2%	63	72.4%	42	85.7%	41	78.8%	113	80.1%	386	77.0%
女性	13	86.7%	28	62.2%	33	73.3%	42	60.9%	69	65.1%	26	59.1%	35	63.6%	143	75.7%	389	68.5%
男女合計	29	74.4%	64	69.6%	68	76.4%	82	65.1%	132	68.4%	68	73.1%	76	71.0%	256	77.6%	775	72.5%
無回答																		
男性	4	16.7%	0	0.0%	0	0.0%	0	0.0%	2	2.3%	0	0.0%	0	0.0%	3	2.1%	9	1.8%
女性	1	6.7%	1	2.2%	0	0.0%	0	0.0%	0	0.0%	0	0.0%	2	3.6%	9	4.8%	13	2.3%
男女合計	5	12.8%	1	1.1%	0	0.0%	0	0.0%	2	1.0%	0	0.0%	2	1.9%	12	3.6%	22	2.1%
全体(人)																		
男性	24		47		44		57		87		49		52		141		501	
女性	15		45		45		69		106		44		55		189		568	
男女合計	39		92		89		126		193		93		107		330		1069	

県 中

	10	割合	20	割合	30	割合	40	割合	50	割合	64	割合	69	割合	70～	割合	全体数	割合
1と回答																		
男性	1	4.8%	9	28.1%	16	31.4%	12	18.2%	22	25.0%	14	29.8%	10	22.7%	29	20.3%	113	23.0%
女性	3	15.0%	10	27.0%	21	38.9%	28	38.4%	33	41.8%	20	40.0%	16	36.4%	32	20.3%	163	31.7%
男女合計	4	9.8%	19	27.5%	37	35.2%	40	28.8%	55	32.9%	34	35.1%	26	29.5%	61	20.3%	276	27.4%
2と回答																		
男性	14	66.7%	23	71.9%	35	68.6%	54	81.8%	66	75.0%	33	70.2%	34	77.3%	112	78.3%	371	75.4%
女性	16	80.0%	27	73.0%	33	61.1%	45	61.6%	46	58.2%	29	58.0%	28	63.6%	119	75.3%	343	66.6%
男女合計	30	73.2%	50	72.5%	68	64.8%	99	71.2%	112	67.1%	62	63.9%	62	70.5%	231	76.7%	714	70.9%
無回答																		
男性	6	28.6%	0	0.0%	0	0.0%	0	0.0%	0	0.0%	0	0.0%	0	0.0%	2	1.4%	8	1.6%
女性	1	5.0%	0	0.0%	0	0.0%	0	0.0%	0	0.0%	1	2.0%	0	0.0%	7	4.4%	9	1.7%
男女合計	7	17.1%	0	0.0%	0	0.0%	0	0.0%	0	0.0%	1	1.0%	0	0.0%	9	3.0%	17	1.7%
全体(人)																		
男性	21		32		51		66		88		47		44		143		492	
女性	20		37		54		73		79		50		44		158		515	
男女合計	41		69		105		139		167		97		88		301		1007	

県 南

	10	割合	20	割合	30	割合	40	割合	50	割合	64	割合	69	割合	70～	割合	全体数	割合
1と回答																		
男性	1	8.3%	0	0.0%	3	15.0%	9	42.9%	8	23.5%	5	23.8%	6	28.6%	18	22.8%	50	23.3%
女性	0	0.0%	4	36.4%	7	46.7%	6	21.4%	12	34.3%	13	50.0%	10	41.7%	18	18.6%	70	28.5%
男女合計	1	4.5%	4	22.2%	10	28.6%	15	30.6%	20	29.0%	18	38.3%	16	35.6%	36	20.5%	120	26.0%
2と回答																		
男性	9	75.0%	7	100.0%	15	75.0%	11	52.4%	26	76.5%	16	76.2%	15	71.4%	60	75.9%	159	74.0%
女性	10	100.0%	7	63.6%	8	53.3%	22	78.6%	22	62.9%	13	50.0%	14	58.3%	73	75.3%	169	68.7%
男女合計	19	86.4%	14	77.8%	23	65.7%	33	67.3%	48	69.6%	29	61.7%	29	64.4%	133	75.6%	328	71.1%
無回答																		
男性	2	16.7%	0	0.0%	2	10.0%	1	4.8%	0	0.0%	0	0.0%	0	0.0%	1	1.3%	6	2.8%
女性	0	0.0%	0	0.0%	0	0.0%	0	0.0%	1	2.9%	0	0.0%	0	0.0%	6	6.2%	7	2.8%
男女合計	2	9.1%	0	0.0%	2	5.7%	1	2.0%	1	1.4%	0	0.0%	0	0.0%	7	4.0%	13	2.8%
全体(人)																		
男性	12		7		20		21		34		21		21		79		215	
女性	10		11		15		28		35		26		24		97		246	
男女合計	22		18		35		49		69		47		45		176		461	

会 津

	10	割合	20	割合	30	割合	40	割合	50	割合	64	割合	69	割合	70～	割合	全体数	割合
1と回答																		
男性	0	0.0%	4	22.2%	11	39.3%	17	39.5%	14	43.8%	3	13.6%	6	24.0%	17	17.2%	72	26.4%
女性	3	42.9%	2	18.2%	16	64.0%	13	34.2%	19	45.2%	8	28.6%	10	31.3%	22	18.8%	93	31.0%
男女合計	3	23.1%	6	20.7%	27	50.9%	30	37.0%	33	44.6%	11	22.0%	16	28.1%	39	18.1%	165	28.8%
2と回答																		
男性	6	100.0%	14	77.8%	17	60.7%	26	60.5%	18	56.3%	18	81.8%	18	72.0%	81	81.8%	198	72.5%
女性	2	28.6%	9	81.8%	9	36.0%	25	65.8%	23	54.8%	20	71.4%	22	68.8%	88	75.2%	198	66.0%
男女合計	8	61.5%	23	79.3%	26	49.1%	51	63.0%	41	55.4%	38	76.0%	40	70.2%	169	78.2%	396	69.1%
無回答																		
男性	0	0.0%	0	0.0%	0	0.0%	0	0.0%	0	0.0%	1	4.5%	1	4.0%	1	1.0%	3	1.1%
女性	2	28.6%	0	0.0%	0	0.0%	0	0.0%	0	0.0%	0	0.0%	0	0.0%	7	6.0%	9	3.0%
男女合計	2	15.4%	0	0.0%	0	0.0%	0	0.0%	0	0.0%	1	2.0%	1	1.8%	8	3.7%	12	2.1%
全体(人)																		
男性	6		18		28		43		32		22		25		99		273	
女性	7		11		25		38		42		28		32		117		300	
男女合計	13		29		53		81		74		50		57		216		573	

南会津

	10	割合	20	割合	30	割合	40	割合	50	割合	64	割合	69	割合	70～	割合	全体数	割合
1と回答																		
男性	0	0.0%	0	0.0%	0	0.0%	0	0.0%	1	33.3%	0	0.0%	0	0.0%	3	21.4%	4	13.3%
女性	0	0.0%	0	0.0%	0	0.0%	1	33.3%	1	100.0%	0	0.0%	0	0.0%	3	23.1%	5	19.2%
男女合計	0	0.0%	0	0.0%	0	0.0%	1	16.7%	2	50.0%	0	0.0%	0	0.0%	6	22.2%	9	16.1%
2と回答																		
男性	0	0.0%	3	100.0%	2	100.0%	3	100.0%	2	66.7%	1	100.0%	4	100.0%	11	78.6%	26	86.7%
女性	0	0.0%	0	0.0%	2	100.0%	2	66.7%	0	0.0%	3	100.0%	4	100.0%	9	69.2%	20	76.9%
男女合計	0	0.0%	3	100.0%	4	100.0%	5	83.3%	2	50.0%	4	100.0%	8	100.0%	20	74.1%	46	82.1%
無回答																		
男性	0	0.0%	0	0.0%	0	0.0%	0	0.0%	0	0.0%	0	0.0%	0	0.0%	0	0.0%	0	0.0%
女性	0	0.0%	0	0.0%	0	0.0%	0	0.0%	0	0.0%	0	0.0%	0	0.0%	1	7.7%	1	3.8%
男女合計	0	0.0%	0	0.0%	0	0.0%	0	0.0%	0	0.0%	0	0.0%	0	0.0%	1	3.7%	1	1.8%
全体(人)																		
男性	0		3		2		3		3		1		4		14		30	
女性	0		0		2		3		1		3		4		13		26	
男女合計	0		3		4		6		4		4		8		27		56	

相 双

	10	割合	20	割合	30	割合	40	割合	50	割合	64	割合	69	割合	70～	割合	全体数	割合
1と回答																		
男性	3	50.0%	0	0.0%	3	25.0%	3	16.7%	4	20.0%	3	21.4%	5	25.0%	9	15.8%	30	19.6%
女性	0	0.0%	0	0.0%	3	21.4%	10	41.7%	8	40.0%	3	27.3%	5	26.3%	10	16.7%	39	24.7%
男女合計	3	25.0%	0	0.0%	6	23.1%	13	31.0%	12	30.0%	6	24.0%	10	25.6%	19	16.2%	69	22.2%
2と回答																		
男性	3	50.0%	6	100.0%	9	75.0%	14	77.8%	16	80.0%	11	78.6%	15	75.0%	48	84.2%	122	79.7%
女性	6	100.0%	4	100.0%	11	78.6%	14	58.3%	12	60.0%	8	72.7%	13	68.4%	45	75.0%	113	71.5%
男女合計	9	75.0%	10	100.0%	20	76.9%	28	66.7%	28	70.0%	19	76.0%	28	71.8%	93	79.5%	235	75.6%
無回答																		
男性	0	0.0%	0	0.0%	0	0.0%	1	5.6%	0	0.0%	0	0.0%	0	0.0%	0	0.0%	1	0.7%
女性	0	0.0%	0	0.0%	0	0.0%	0	0.0%	0	0.0%	0	0.0%	1	5.3%	5	8.3%	6	3.8%
男女合計	0	0.0%	0	0.0%	0	0.0%	1	2.4%	0	0.0%	0	0.0%	1	2.6%	5	4.3%	7	2.3%
全体(人)																		
男性	6		6		12		18		20		14		20		57		153	
女性	6		4		14		24		20		11		19		60		158	
男女合計	12		10		26		42		40		25		39		117		311	

いわき

	10	割合	20	割合	30	割合	40	割合	50	割合	64	割合	69	割合	70～	割合	全体数	割合
1と回答																		
男性	1	7.7%	2	20.0%	8	22.9%	10	33.3%	6	12.5%	8	19.0%	11	24.4%	25	19.4%	71	20.2%
女性	1	6.3%	5	29.4%	11	39.3%	9	31.0%	20	31.7%	9	19.6%	15	34.9%	32	22.7%	102	26.6%
男女合計	2	6.9%	7	25.9%	19	30.2%	19	32.2%	26	23.4%	17	19.3%	26	29.5%	57	21.1%	173	23.5%
2と回答																		
男性	11	84.6%	8	80.0%	27	77.1%	20	66.7%	42	87.5%	34	81.0%	33	73.3%	101	78.3%	276	78.4%
女性	15	93.8%	12	70.6%	17	60.7%	20	69.0%	43	68.3%	37	80.4%	28	65.1%	105	74.5%	277	72.3%
男女合計	26	89.7%	20	74.1%	44	69.8%	40	67.8%	85	76.6%	71	80.7%	61	69.3%	206	76.3%	553	75.2%
無回答																		
男性	1	7.7%	0	0.0%	0	0.0%	0	0.0%	0	0.0%	0	0.0%	1	2.2%	3	2.3%	5	1.4%
女性	0	0.0%	0	0.0%	0	0.0%	0	0.0%	0	0.0%	0	0.0%	0	0.0%	4	2.8%	4	1.0%
男女合計	1	3.4%	0	0.0%	0	0.0%	0	0.0%	0	0.0%	0	0.0%	1	1.1%	7	2.6%	9	1.2%
全体(人)																		
男性	13		10		35		30		48		42		45		129		352	
女性	16		17		28		29		63		46		43		141		383	
男女合計	29		27		63		59		111		88		88		270		735	

全県 (60歳以上・再掲)

	64	割合	69	割合	70	割合	80	割合	90	割合	全体数	割合
1と回答												
男性	40	20.4%	49	23.2%	93	21.5%	27	14.4%	6	14.0%	215	20.1%
女性	71	34.1%	74	33.5%	99	23.3%	48	17.3%	7	9.6%	299	24.8%
男女合計	111	27.5%	123	28.5%	192	22.4%	75	16.2%	13	11.2%	514	22.6%
2と回答												
男性	155	79.1%	160	75.8%	334	77.3%	156	83.4%	36	83.7%	841	78.7%
女性	136	65.4%	144	65.2%	305	71.8%	213	76.9%	64	87.7%	862	71.6%
男女合計	291	72.0%	304	70.4%	639	74.6%	369	79.5%	100	86.2%	1703	74.9%
無回答												
男性	1	0.5%	2	0.9%	5	1.2%	4	2.1%	1	2.3%	13	1.2%
女性	1	0.5%	3	1.4%	21	4.9%	16	5.8%	2	2.7%	43	3.6%
男女合計	2	0.5%	5	1.2%	26	3.0%	20	4.3%	3	2.6%	56	2.5%
全体(人)												
男性	196		211		432		187		43		1069	
女性	208		221		425		277		73		1204	
男女合計	404		432		857		464		116		2273	

15 飲酒の状況（満20歳以上対象）（調査票 問15）

(1) 飲酒の頻度

問15 あなたは、どのくらいお酒を飲んでますか。（あてはまる番号1つに○）

- 1 毎日飲んでいる
- 2 週に5～6回飲んでいる
- 3 週に3～4回飲んでいる
- 4 たまに飲む程度
- 5 以前は飲んでいましたが、今は飲んでいない
- 6 もともと飲まない

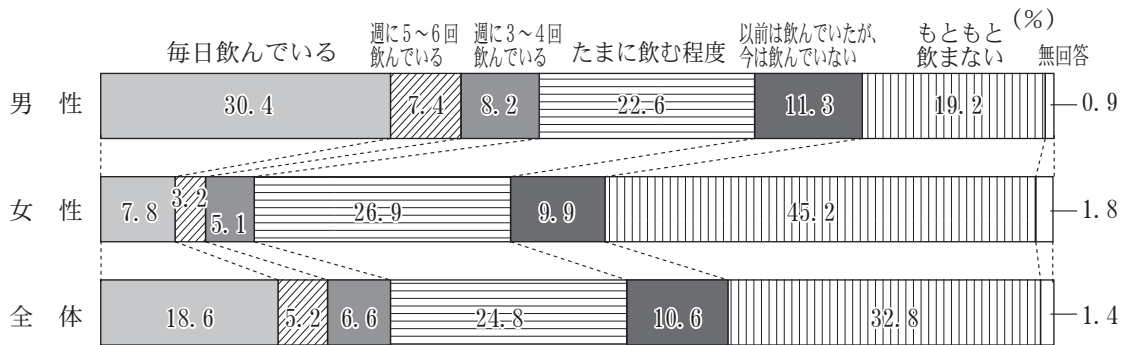

	20	割合	30	割合	40	割合	50	割合	64	割合	69	割合	70	割合	80	割合	90	割合	全体数	割合
1と回答																				
男性	2	1.6%	31	16.1%	60	25.2%	108	34.6%	70	35.7%	84	39.8%	169	39.1%	57	30.5%	6	14.0%	587	30.4%
女性	1	0.8%	12	6.6%	37	14.0%	34	9.8%	22	10.6%	20	9.0%	30	7.1%	10	3.6%	0	0.0%	166	7.8%
男女合計	3	1.2%	43	11.5%	97	19.3%	142	21.6%	92	22.8%	104	24.1%	199	23.2%	67	14.4%	6	5.2%	753	18.6%
2と回答																				
男性	2	1.6%	16	8.3%	25	10.5%	26	8.3%	25	12.8%	18	8.5%	24	5.6%	8	4.3%	0	0.0%	144	7.4%
女性	1	0.8%	5	2.7%	10	3.8%	11	3.2%	11	5.3%	16	7.2%	12	2.8%	2	0.7%	0	0.0%	68	3.2%
男女合計	3	1.2%	21	5.6%	35	7.0%	37	5.6%	36	8.9%	34	7.9%	36	4.2%	10	2.2%	0	0.0%	212	5.2%
3と回答																				
男性	11	8.9%	15	7.8%	27	11.3%	30	9.6%	17	8.7%	18	8.5%	27	6.3%	12	6.4%	2	4.7%	159	8.2%
女性	3	2.4%	4	2.2%	22	8.3%	25	7.2%	17	8.2%	10	4.5%	17	4.0%	9	3.2%	1	1.4%	108	5.1%
男女合計	14	5.6%	19	5.1%	49	9.8%	55	8.4%	34	8.4%	28	6.5%	44	5.1%	21	4.5%	3	2.6%	267	6.6%
4と回答																				
男性	67	54.5%	64	33.3%	59	24.8%	68	21.8%	38	19.4%	37	17.5%	72	16.7%	25	13.4%	7	16.3%	437	22.6%
女性	58	46.4%	77	42.1%	79	29.9%	107	30.9%	49	23.6%	62	28.1%	97	22.8%	35	12.6%	6	8.2%	570	26.9%
男女合計	125	50.4%	141	37.6%	138	27.5%	175	26.6%	87	21.5%	99	22.9%	169	19.7%	60	12.9%	13	11.2%	1007	24.8%
5と回答																				
男性	3	2.4%	12	6.3%	13	5.5%	25	8.0%	10	5.1%	26	12.3%	76	17.6%	41	21.9%	13	30.2%	219	11.3%
女性	15	12.0%	28	15.3%	30	11.4%	38	11.0%	22	10.6%	17	7.7%	30	7.1%	20	7.2%	11	15.1%	211	9.9%
男女合計	18	7.3%	40	10.7%	43	8.6%	63	9.6%	32	7.9%	43	10.0%	106	12.4%	61	13.1%	24	20.7%	430	10.6%
6と回答																				
男性	38	30.9%	54	28.1%	54	22.7%	54	17.3%	36	18.4%	26	12.3%	57	13.2%	38	20.3%	14	32.6%	371	19.2%
女性	47	37.6%	57	31.1%	86	32.6%	131	37.9%	86	41.3%	96	43.4%	221	52.0%	182	65.7%	54	74.0%	960	45.2%
男女合計	85	34.3%	111	29.6%	140	27.9%	185	28.1%	122	30.2%	122	28.2%	278	32.4%	220	47.4%	68	58.6%	1331	32.8%
無回答																				
男性	0	0.0%	0	0.0%	0	0.0%	1	0.3%	0	0.0%	2	0.9%	7	1.6%	6	3.2%	1	2.3%	17	0.9%
女性	0	0.0%	0	0.0%	0	0.0%	0	0.0%	1	0.5%	0	0.0%	18	4.2%	19	6.9%	1	1.4%	39	1.8%
男女合計	0	0.0%	0	0.0%	0	0.0%	1	0.2%	1	0.2%	2	0.5%	25	2.9%	25	5.4%	2	1.7%	56	1.4%
全体(人)																				
男性	123		192		238		312		196		211		432		187		43		1934	
女性	125		183		264		346		208		221		425		277		73		2122	
男女合計	248		375		502		658		404		432		857		464		116		4056	

県 北

	20	割合	30	割合	40	割合	50	割合	64	割合	69	割合	70～	割合	全体数	割合
1と回答																
男性	0	0.0%	9	20.5%	16	28.1%	29	33.3%	17	34.7%	19	36.5%	51	36.2%	141	29.6%
女性	0	0.0%	3	6.7%	9	13.0%	11	10.4%	7	15.9%	4	7.3%	9	4.8%	43	7.8%
男女合計	0	0.0%	12	13.5%	25	19.8%	40	20.7%	24	25.8%	23	21.5%	60	18.2%	184	17.9%
2と回答																
男性	0	0.0%	5	11.4%	5	8.8%	8	9.2%	9	18.4%	4	7.7%	3	2.1%	34	7.1%
女性	0	0.0%	1	2.2%	2	2.9%	2	1.9%	1	2.3%	6	10.9%	2	1.1%	14	2.5%
男女合計	0	0.0%	6	6.7%	7	5.6%	10	5.2%	10	10.8%	10	9.3%	5	1.5%	48	4.7%
3と回答																
男性	5	10.6%	2	4.5%	3	5.3%	7	8.0%	4	8.2%	5	9.6%	10	7.1%	36	7.5%
女性	2	4.4%	0	0.0%	6	8.7%	7	6.6%	3	6.8%	5	9.1%	5	2.6%	28	5.1%
男女合計	7	7.6%	2	2.2%	9	7.1%	14	7.3%	7	7.5%	10	9.3%	15	4.5%	64	6.2%
4と回答																
男性	22	46.8%	13	29.5%	14	24.6%	20	23.0%	9	18.4%	11	21.2%	18	12.8%	107	22.4%
女性	21	46.7%	21	46.7%	25	36.2%	36	34.0%	14	31.8%	15	27.3%	33	17.5%	165	29.8%
男女合計	43	46.7%	34	38.2%	39	31.0%	56	29.0%	23	24.7%	26	24.3%	51	15.5%	272	26.4%
5と回答																
男性	1	2.1%	5	11.4%	3	5.3%	9	10.3%	3	6.1%	7	13.5%	33	23.4%	61	12.8%
女性	7	15.6%	4	8.9%	6	8.7%	13	12.3%	4	9.1%	6	10.9%	23	12.2%	63	11.4%
男女合計	8	8.7%	9	10.1%	9	7.1%	22	11.4%	7	7.5%	13	12.1%	56	17.0%	124	12.0%
6と回答																
男性	19	40.4%	10	22.7%	16	28.1%	13	14.9%	7	14.3%	6	11.5%	25	17.7%	96	20.1%
女性	15	33.3%	16	35.6%	21	30.4%	37	34.9%	15	34.1%	19	34.5%	109	57.7%	232	42.0%
男女合計	34	37.0%	26	29.2%	37	29.4%	50	25.9%	22	23.7%	25	23.4%	134	40.6%	328	31.8%
無回答																
男性	0	0.0%	0	0.0%	0	0.0%	1	1.1%	0	0.0%	0	0.0%	1	0.7%	2	0.4%
女性	0	0.0%	0	0.0%	0	0.0%	0	0.0%	0	0.0%	0	0.0%	8	4.2%	8	1.4%
男女合計	0	0.0%	0	0.0%	0	0.0%	1	0.5%	0	0.0%	0	0.0%	9	2.7%	10	1.0%
全体(人)																
男性	47		44		57		87		49		52		141		477	
女性	45		45		69		106		44		55		189		553	
男女合計	92		89		126		193		93		107		330		1030	

県 中

	20	割合	30	割合	40	割合	50	割合	64	割合	69	割合	70～	割合	全体数	割合
1と回答																
男性	0	0.0%	11	21.6%	19	28.8%	25	28.4%	16	34.0%	17	38.6%	50	35.0%	138	29.3%
女性	1	2.7%	5	9.3%	10	13.7%	5	6.3%	4	8.0%	2	4.5%	9	5.7%	36	7.3%
男女合計	1	1.4%	16	15.2%	29	20.9%	30	18.0%	20	20.6%	19	21.6%	59	19.6%	174	18.0%
2と回答																
男性	2	6.3%	5	9.8%	9	13.6%	10	11.4%	5	10.6%	4	9.1%	7	4.9%	42	8.9%
女性	0	0.0%	2	3.7%	6	8.2%	6	7.6%	2	4.0%	4	9.1%	4	2.5%	24	4.8%
男女合計	2	2.9%	7	6.7%	15	10.8%	16	9.6%	7	7.2%	8	9.1%	11	3.7%	66	6.8%
3と回答																
男性	3	9.4%	5	9.8%	14	21.2%	11	12.5%	3	6.4%	4	9.1%	7	4.9%	47	10.0%
女性	1	2.7%	3	5.6%	4	5.5%	6	7.6%	2	4.0%	0	0.0%	4	2.5%	20	4.0%
男女合計	4	5.8%	8	7.6%	18	12.9%	17	10.2%	5	5.2%	4	4.5%	11	3.7%	67	6.9%
4と回答																
男性	17	53.1%	17	33.3%	13	19.7%	20	22.7%	14	29.8%	10	22.7%	21	14.7%	112	23.8%
女性	15	40.5%	21	38.9%	19	26.0%	28	35.4%	12	24.0%	14	31.8%	31	19.6%	140	28.3%
男女合計	32	46.4%	38	36.2%	32	23.0%	48	28.7%	26	26.8%	24	27.3%	52	17.3%	252	26.1%
5と回答																
男性	1	3.1%	1	2.0%	3	4.5%	6	6.8%	1	2.1%	6	13.6%	28	19.6%	46	9.8%
女性	1	2.7%	8	14.8%	11	15.1%	11	13.9%	11	22.0%	4	9.1%	10	6.3%	56	11.3%
男女合計	2	2.9%	9	8.6%	14	10.1%	17	10.2%	12	12.4%	10	11.4%	38	12.6%	102	10.6%
6と回答																
男性	9	28.1%	12	23.5%	8	12.1%	16	18.2%	8	17.0%	3	6.8%	24	16.8%	80	17.0%
女性	19	51.4%	15	27.8%	23	31.5%	23	29.1%	19	38.0%	20	45.5%	91	57.6%	210	42.4%
男女合計	28	40.6%	27	25.7%	31	22.3%	39	23.4%	27	27.8%	23	26.1%	115	38.2%	290	30.0%
無回答																
男性	0	0.0%	0	0.0%	0	0.0%	0	0.0%	0	0.0%	0	0.0%	6	4.2%	6	1.3%
女性	0	0.0%	0	0.0%	0	0.0%	0	0.0%	0	0.0%	0	0.0%	9	5.7%	9	1.8%
男女合計	0	0.0%	0	0.0%	0	0.0%	0	0.0%	0	0.0%	0	0.0%	15	5.0%	15	1.6%
全体(人)																
男性	32		51		66		88		47		44		143		471	
女性	37		54		73		79		50		44		158		495	
男女合計	69		105		139		167		97		88		301		966	

県 南

	20	割合	30	割合	40	割合	50	割合	64	割合	69	割合	70～	割合	全体数	割合
1と回答																
男性	0	0.0%	1	5.0%	5	23.8%	13	38.2%	9	42.9%	8	38.1%	26	32.9%	62	30.5%
女性	0	0.0%	0	0.0%	4	14.3%	2	5.7%	2	7.7%	2	8.3%	5	5.2%	15	6.4%
男女合計	0	0.0%	1	2.9%	9	18.4%	15	21.7%	11	23.4%	10	22.2%	31	17.6%	77	17.5%
2と回答																
男性	0	0.0%	2	10.0%	2	9.5%	0	0.0%	3	14.3%	0	0.0%	8	10.1%	15	7.4%
女性	0	0.0%	2	13.3%	0	0.0%	0	0.0%	2	7.7%	1	4.2%	2	2.1%	7	3.0%
男女合計	0	0.0%	4	11.4%	2	4.1%	0	0.0%	5	10.6%	1	2.2%	10	5.7%	22	5.0%
3と回答																
男性	0	0.0%	3	15.0%	2	9.5%	3	8.8%	1	4.8%	3	14.3%	1	1.3%	13	6.4%
女性	0	0.0%	0	0.0%	3	10.7%	1	2.9%	2	7.7%	0	0.0%	5	5.2%	11	4.7%
男女合計	0	0.0%	3	8.6%	5	10.2%	4	5.8%	3	6.4%	3	6.7%	6	3.4%	24	5.5%
4と回答																
男性	6	85.7%	7	35.0%	2	9.5%	9	26.5%	2	9.5%	4	19.0%	17	21.5%	47	23.2%
女性	9	81.8%	5	33.3%	5	17.9%	10	28.6%	5	19.2%	10	41.7%	16	16.5%	60	25.4%
男女合計	15	83.3%	12	34.3%	7	14.3%	19	27.5%	7	14.9%	14	31.1%	33	18.8%	107	24.4%
5と回答																
男性	0	0.0%	0	0.0%	1	4.8%	2	5.9%	2	9.5%	3	14.3%	12	15.2%	20	9.9%
女性	1	9.1%	3	20.0%	4	14.3%	5	14.3%	2	7.7%	0	0.0%	6	6.2%	21	8.9%
男女合計	1	5.6%	3	8.6%	5	10.2%	7	10.1%	4	8.5%	3	6.7%	18	10.2%	41	9.3%
6と回答																
男性	1	14.3%	7	35.0%	9	42.9%	7	20.6%	4	19.0%	3	14.3%	13	16.5%	44	21.7%
女性	1	9.1%	5	33.3%	12	42.9%	17	48.6%	13	50.0%	11	45.8%	59	60.8%	118	50.0%

いわき

	20	割合	30	割合	40	割合	50	割合	64	割合	69	割合	70～	割合	全体数	割合
1と回答																
男性	2	20.0%	5	14.3%	7	23.3%	19	39.6%	13	31.0%	16	35.6%	48	37.2%	110	32.4%
女性	0	0.0%	0	0.0%	4	13.8%	7	11.1%	5	10.9%	3	7.0%	4	2.8%	23	6.3%
男女合計	2	7.4%	5	7.9%	11	18.6%	26	23.4%	18	20.5%	19	21.6%	52	19.3%	133	18.8%
2と回答																
男性	0	0.0%	1	2.9%	2	6.7%	2	4.2%	3	7.1%	4	8.9%	2	1.6%	14	4.1%
女性	0	0.0%	0	0.0%	0	0.0%	3	4.8%	4	8.7%	2	4.7%	3	2.1%	12	3.3%
男女合計	0	0.0%	1	1.6%	2	3.4%	5	4.5%	7	8.0%	6	6.8%	5	1.9%	26	3.7%
3と回答																
男性	1	10.0%	2	5.7%	4	13.3%	4	8.3%	5	11.9%	5	11.1%	11	8.5%	32	9.4%
女性	0	0.0%	0	0.0%	2	6.9%	4	6.3%	5	10.9%	3	7.0%	5	3.5%	19	5.2%
男女合計	1	3.7%	2	3.2%	6	10.2%	8	7.2%	10	11.4%	8	9.1%	16	5.9%	51	7.2%
4と回答																
男性	3	30.0%	11	31.4%	7	23.3%	10	20.8%	10	23.8%	6	13.3%	24	18.6%	71	20.9%
女性	7	41.2%	12	42.9%	9	31.0%	16	25.4%	10	21.7%	10	23.3%	22	15.6%	86	23.4%
男女合計	10	37.0%	23	36.5%	16	27.1%	26	23.4%	20	22.7%	16	18.2%	46	17.0%	157	22.2%
5と回答																
男性	0	0.0%	3	8.6%	2	6.7%	5	10.4%	1	2.4%	6	13.3%	19	14.7%	36	10.6%
女性	2	11.8%	6	21.4%	3	10.3%	5	7.9%	2	4.3%	4	9.3%	10	7.1%	32	8.7%
男女合計	2	7.4%	9	14.3%	5	8.5%	10	9.0%	3	3.4%	10	11.4%	29	10.7%	68	9.6%
6と回答																
男性	4	40.0%	13	37.1%	8	26.7%	8	16.7%	10	23.8%	6	13.3%	23	17.8%	72	21.2%
女性	8	47.1%	10	35.7%	11	37.9%	28	44.4%	19	41.3%	21	48.8%	90	63.8%	187	51.0%
男女合計	12	44.4%	23	36.5%	19	32.2%	36	32.4%	29	33.0%	27	30.7%	113	41.9%	259	36.7%
無回答																
男性	0	0.0%	0	0.0%	0	0.0%	0	0.0%	0	0.0%	2	4.4%	2	1.6%	4	1.2%
女性	0	0.0%	0	0.0%	0	0.0%	0	0.0%	1	2.2%	0	0.0%	7	5.0%	8	2.2%
男女合計	0	0.0%	0	0.0%	0	0.0%	0	0.0%	1	1.1%	2	2.3%	9	3.3%	12	1.7%
全体(人)																
男性	10		35		30		48		42		45		129		339	
女性	17		28		29		63		46		43		141		367	
男女合計	27		63		59		111		88		88		270		706	

(2) 飲酒の量 (調査票 問15付問)

付問 問15で1～4を選んだ方におたずねします。あなたが1回に飲む量はどれくらいですか。日本酒にあてはめて計算し、あてはまる番号を1つ選んで○をつけてください。(計算の仕方は、下記のとおりでです。)

1 極少量 2 1合程度 3 2合程度 4 3合以上

日本酒1合あたりのアルコール量は以下と同等
 ・焼酎(25度、100ml)
 ・ビール中瓶1本(500ml)
 ・ウィスキーダブル1杯(60ml)
 ・ワイングラス2杯(200ml)
 うすめて飲むときは、もとの量で計算してください。

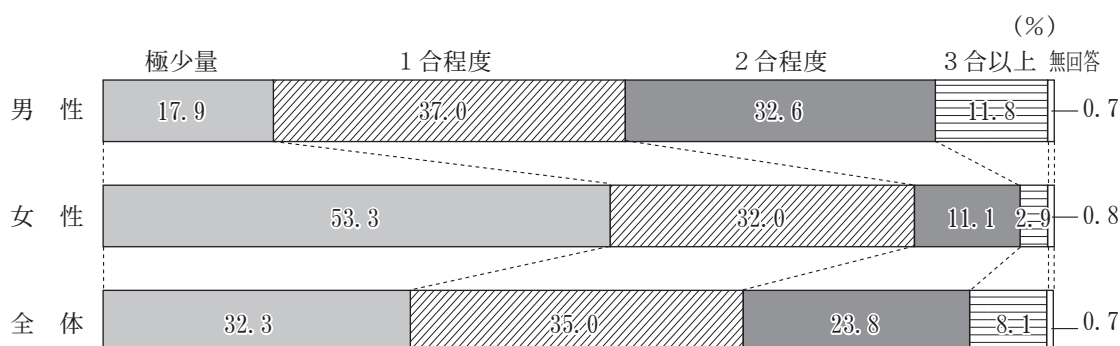

	20	割合	30	割合	40	割合	50	割合	64	割合	69	割合	70	割合	80	割合	90	割合	全体数	割合
1と回答																				
男性	29	35.4%	28	22.2%	34	19.9%	38	16.4%	16	10.7%	13	8.3%	51	17.5%	24	23.5%	5	33.3%	238	17.9%
女性	35	55.6%	44	44.9%	66	44.6%	89	50.3%	51	51.5%	58	53.7%	90	57.7%	46	82.1%	7	100.0%	486	53.3%
男女合計	64	44.1%	72	32.1%	100	31.3%	127	31.1%	67	26.9%	71	26.8%	141	31.5%	70	44.3%	12	54.5%	724	32.3%
2と回答																				
男性	32	39.0%	53	42.1%	66	38.6%	70	30.2%	48	32.0%	63	40.1%	108	37.0%	46	45.1%	5	33.3%	491	37.0%
女性	16	25.4%	39	39.8%	54	36.5%	64	36.2%	29	29.3%	36	33.3%	46	29.5%	8	14.3%	0	0.0%	292	32.0%
男女合計	48	33.1%	92	41.1%	120	37.6%	134	32.8%	77	30.9%	99	37.4%	154	34.4%	54	34.2%	5	22.7%	783	35.0%
3と回答																				
男性	14	17.1%	28	22.2%	50	29.2%	83	35.8%	58	38.7%	57	36.3%	111	38.0%	27	26.5%	5	33.3%	433	32.6%
女性	9	14.3%	9	9.2%	24	16.2%	21	11.9%	12	12.1%	11	10.2%	15	9.6%	0	0.0%	0	0.0%	101	11.1%
男女合計	23	15.9%	37	16.5%	74	23.2%	104	25.4%	70	28.1%	68	25.7%	126	28.1%	27	17.1%	5	22.7%	534	23.8%
4と回答																				
男性	7	8.5%	16	12.7%	20	11.7%	40	17.2%	27	18.0%	23	14.6%	19	6.5%	4	3.9%	0	0.0%	156	11.8%
女性	3	4.8%	6	6.1%	4	2.7%	3	1.7%	7	7.1%	1	0.9%	2	1.3%	0	0.0%	0	0.0%	26	2.9%
男女合計	10	6.9%	22	9.8%	24	7.5%	43	10.5%	34	13.7%	24	9.1%	21	4.7%	4	2.5%	0	0.0%	182	8.1%
無回答																				
男性	0	0.0%	1	0.8%	1	0.6%	1	0.4%	1	0.7%	1	0.6%	3	1.0%	1	1.0%	0	0.0%	9	0.7%
女性	0	0.0%	0	0.0%	0	0.0%	0	0.0%	0	0.0%	2	1.9%	3	1.9%	2	3.6%	0	0.0%	7	0.8%
男女合計	0	0.0%	1	0.4%	1	0.3%	1	0.2%	1	0.4%	3	1.1%	6	1.3%	3	1.9%	0	0.0%	16	0.7%
全体(人)																				
男性	82		126		171		232		150		157		292		102		15		1327	
女性	63		98		148		177		99		108		156		56		7		912	
男女合計	145		224		319		409		249		265		448		158		22		2239	

県 北

	20	割合	30	割合	40	割合	50	割合	64	割合	69	割合	70～	割合	全体数	割合
1と回答																
男性	8	29.6%	9	31.0%	9	23.7%	12	18.8%	6	15.4%	5	12.8%	19	23.2%	68	21.4%
女性	13	56.5%	12	48.0%	15	35.7%	25	44.6%	14	56.0%	15	50.0%	33	67.3%	127	50.8%
男女合計	21	42.0%	21	38.9%	24	30.0%	37	30.8%	20	31.3%	20	29.0%	52	39.7%	195	34.3%
2と回答																
男性	10	37.0%	7	24.1%	14	36.8%	18	28.1%	13	33.3%	10	25.6%	32	39.0%	104	32.7%
女性	5	21.7%	9	36.0%	21	50.0%	24	42.9%	7	28.0%	10	33.3%	11	22.4%	87	34.8%
男女合計	15	30.0%	16	29.6%	35	43.8%	42	35.0%	20	31.3%	20	29.0%	43	32.8%	191	33.6%
3と回答																
男性	7	25.9%	8	27.6%	9	23.7%	25	39.1%	13	33.3%	18	46.2%	26	31.7%	106	33.3%
女性	5	21.7%	1	4.0%	5	11.9%	6	10.7%	3	12.0%	4	13.3%	3	6.1%	27	10.8%
男女合計	12	24.0%	9	16.7%	14	17.5%	31	25.8%	16	25.0%	22	31.9%	29	22.1%	133	23.4%
4と回答																
男性	2	7.4%	5	17.2%	5	13.2%	8	12.5%	6	15.4%	6	15.4%	5	6.1%	37	11.6%
女性	0	0.0%	3	12.0%	1	2.4%	1	1.8%	1	4.0%	0	0.0%	0	0.0%	6	2.4%
男女合計	2	4.0%	8	14.8%	6	7.5%	9	7.5%	7	10.9%	6	8.7%	5	3.8%	43	7.6%
無回答																
男性	0	0.0%	0	0.0%	1	2.6%	1	1.6%	1	2.6%	0	0.0%	0	0.0%	3	0.9%
女性	0	0.0%	0	0.0%	0	0.0%	0	0.0%	0	0.0%	1	3.3%	2	4.1%	3	1.2%
男女合計	0	0.0%	0	0.0%	1	1.3%	1	0.8%	1	1.6%	1	1.4%	2	1.5%	6	1.1%
全体(人)																
男性	27		29		38		64		39		39		82		318	
女性	23		25		42		56		25		30		49		250	
男女合計	50		54		80		120		64		69		131		568	

県 中

	20	割合	30	割合	40	割合	50	割合	64	割合	69	割合	70～	割合	全体数	割合
1と回答																
男性	9	40.9%	4	10.5%	8	14.5%	6	9.1%	6	15.8%	3	8.6%	18	21.2%	54	15.9%
女性	6	35.3%	15	48.4%	20	51.3%	27	60.0%	7	35.0%	12	60.0%	33	68.8%	120	54.5%
男女合計	15	38.5%	19	27.5%	28	29.8%	33	29.7%	13	22.4%	15	27.3%	51	38.3%	174	31.1%
2と回答																
男性	7	31.8%	20	52.6%	24	43.6%	21	31.8%	12	31.6%	16	45.7%	28	32.9%	128	37.8%
女性	7	41.2%	11	35.5%	9	23.1%	12	26.7%	9	45.0%	5	25.0%	10	20.8%	63	28.6%
男女合計	14	35.9%	31	44.9%	33	35.1%	33	29.7%	21	36.2%	21	38.2%	38	28.6%	191	34.2%
3と回答																
男性	4	18.2%	8	21.1%	18	32.7%	26	39.4%	12	31.6%	10	28.6%	30	35.3%	108	31.9%
女性	3	17.6%	2	6.5%	8	20.5%	4	8.9%	3	15.0%	3	15.0%	3	6.3%	26	11.8%
男女合計	7	17.9%	10	14.5%	26	27.7%	30	27.0%	15	25.9%	13	23.6%	33	24.8%	134	24.0%
4と回答																
男性	2	9.1%	6	15.8%	5	9.1%	13	19.7%	8	21.1%	6	17.1%	5	5.9%	45	13.3%
女性	1	5.9%	3	9.7%	2	5.1%	2	4.4%	1	5.0%	0	0.0%	1	2.1%	10	4.5%
男女合計	3	7.7%	9	13.0%	7	7.4%	15	13.5%	9	15.5%	6	10.9%	6	4.5%	55	9.8%
無回答																
男性	0	0.0%	0	0.0%	0	0.0%	0	0.0%	0	0.0%	0	0.0%	4	4.7%	4	1.2%
女性	0	0.0%	0	0.0%	0	0.0%	0	0.0%	0	0.0%	0	0.0%	1	2.1%	1	0.5%
男女合計	0	0.0%	0	0.0%	0	0.0%	0	0.0%	0	0.0%	0	0.0%	5	3.8%	5	0.9%
全体(人)																
男性	22		38		55		66		38		35		85		339	
女性	17		31		39		45		20		20		48		220	
男女合計	39		69		94		111		58		55		133		559	

県 南

	20	割合	30	割合	40	割合	50	割合	64	割合	69	割合	70～	割合	全体数	割合
1と回答																
男性	0	0.0%	0	0.0%	1	9.1%	5	20.0%	0	0.0%	1	6.7%	9	17.3%	16	11.7%
女性	7	77.8%	4	57.1%	4	33.3%	7	53.8%	5	45.5%	9	69.2%	17	60.7%	53	57.0%
男女合計	7	46.7%	4	20.0%	5	21.7%	12	31.6%	5	19.2%	10	35.7%	26	32.5%	69	30.0%
2と回答																
男性	5	83.3%	10	76.9%	5	45.5%	9	36.0%	6	40.0%	5	33.3%	20	38.5%	60	43.8%
女性	0	0.0%	2	28.6%	4	33.3%	4	30.8%	5	45.5%	3	23.1%	9	32.1%	27	29.0%
男女合計	5	33.3%	12	60.0%	9	39.1%	13	34.2%	11	42.3%	8	28.6%	29	36.3%	87	37.8%
3と回答																
男性	0	0.0%	2	15.4%	5	45.5%	5	20.0%	6	40.0%	5	33.3%	20	38.5%	43	31.4%
女性	1	11.1%	1	14.3%	4	33.3%	2	15.4%	0	0.0%	1	7.7%	1	3.6%	10	10.8%
男女合計	1	6.7%	3	15.0%	9	39.1%	7	18.4%	6	23.1%	6	21.4%	21	26.3%	53	23.0%
4と回答																
男性	1	16.7%	1	7.7%	0	0.0%	6	24.0%	3	20.0%	4	26.7%	3	5.8%	18	13.1%
女性	1	11.1%	0	0.0%	0	0.0%	0	0.0%	1	9.1%	0	0.0%	0	0.0%	2	2.2%
男女合計	2	13.3%	1	5.0%	0	0.0%	6	15.8%	4	15.4%	4	14.3%	3	3.8%	20	8.7%
無回答																
男性	0	0.0%	0	0.0%	0	0.0%	0	0.0%	0	0.0%	0	0.0%	0	0.0%	0	0.0%
女性	0	0.0%	0	0.0%	0	0.0%	0	0.0%	0	0.0%	0	0.0%	1	3.6%	1	1.1%
男女合計	0	0.0%	0	0.0%	0	0.0%	0	0.0%	0	0.0%	0	0.0%	1	1.3%	1	0.4%
全体(人)																
男性	6		13		11		25		15		15		52		137	
女性	9		7		12		13		11		13		28		93	
男女合計	15		20		23		38		26		28		80		230	

会 津

	20	割合	30	割合	40	割合	50	割合	64	割合	69	割合	70～	割合	全体数	割合
1と回答																
男性	7	50.0%	6	33.3%	8	25.0%	1	3.8%	1	6.3%	0	0.0%	8	13.6%	31	16.8%
女性	2	40.0%	5	38.5%	13	48.1%	11	42.3%	6	46.2%	7	41.2%	23	60.5%	67	48.2%
男女合計	9	47.4%	11	35.5%	21	35.6%	12	23.1%	7	24.1%	7	19.4%	31	32.0%	98	30.3%
2と回答																
男性	4	28.6%	6	33.3%	9	28.1%	11	42.3%	2	12.5%	14	73.7%	24	40.7%	70	38.0%
女性	3	60.0%	7	53.8%	9	33.3%	11	42.3%	3	23.1%	8	47.1%	10	26.3%	51	36.7%
男女合計	7	36.8%	13	41.9%	18	30.5%	22	42.3%	5	17.2%	22	61.1%	34	35.1%	121	37.5%
3と回答																
男性	2	14.3%	4	22.2%	10	31.3%	10	38.5%	9	56.3%	3	15.8%	23	39.0%	61	33.2%
女性	0	0.0%	1	7.7%	5	18.5%	4	15.4%	2	15.4%	1	5.9%	4	10.5%	17	12.2%
男女合計	2	10.5%	5	16.1%	15	25.4%	14	26.9%	11	37.9%	4	11.1%	27	27.8%	78	24.1%
4と回答																
男性	1	7.1%	2	11.1%	5	15.6%	4	15.4%	4	25.0%	1	5.3%	4	6.8%	21	11.4%
女性	0	0.0%	0	0.0%	0	0.0%	0	0.0%	2	15.4%	1	5.9%	0	0.0%	3	2.2%
男女合計	1	5.3%	2	6.5%	5	8.5%	4	7.7%	6	20.7%	2	5.6%	4	4.1%	24	7.4%
無回答																
男性	0	0.0%	0	0.0%	0	0.0%	0	0.0%	0	0.0%	1	5.3%	0	0.0%	1	0.5%
女性	0	0.0%	0	0.0%	0	0.0%	0	0.0%	0	0.0%	0	0.0%	1	2.6%	1	0.7%
男女合計	0	0.0%	0	0.0%	0	0.0%	0	0.0%	0	0.0%	1	2.8%	1	1.0%	2	0.6%
全体(人)																
男性	14		18		32		26		16		19		59		184	
女性	5		13		27		26		13		17		38		139	
男女合計	19		31		59		52		29		36		97		323	

南 会 津

	20	割合	30	割合	40	割合	50	割合	64	割合	69	割合	70～	割合	全体数	割合
1と回答																
男性	0	0.0%	0	0.0%	1	33.3%	0	0.0%	0	0.0%	0	0.0%	2	25.0%	3	16.7%
女性	0	0.0%	1	100.0%	2	66.7%	0	0.0%	1	50.0%	1	50.0%	2	100.0%	7	70.0%
男女合計	0	0.0%	1	50.0%	3	50.0%	0	0.0%	1	50.0%	1	20.0%	4	40.0%	10	35.7%
2と回答																
男性	2	100.0%	1	100.0%	1	33.3%	0	0.0%	0	0.0%	1	33.3%	4	50.0%	9	50.0%
女性	0	0.0%	0	0.0%	1	33.3%	0	0.0%	1	50.0%	1	50.0%	0	0.0%	3	30.0%
男女合計	2	100.0%	1	50.0%	2	33.3%	0	0.0%	1	50.0%	2	40.0%	4	40.0%	12	42.9%
3と回答																
男性	0	0.0%	0	0.0%	1	33.3%	1	100.0%	0	0.0%	2	66.7%	2	25.0%	6	33.3%
女性	0	0.0%	0	0.0%	0	0.0%	0	0.0%	0	0.0%	0	0.0%	0	0.0%	0	0.0%
男女合計	0	0.0%	0	0.0%	1	16.7%	1	100.0%	0	0.0%	2	40.0%	2	20.0%	6	21.4%
4と回答																
男性	0	0.0%	0	0.0%	0	0.0%	0	0.0%	0	0.0%	0	0.0%	0	0.0%	0	0.0%
女性	0	0.0%	0	0.0%	0	0.0%	0	0.0%	0	0.0%	0	0.0%	0	0.0%	0	0.0%
男女合計	0	0.0%	0	0.0%	0	0.0%	0	0.0%	0	0.0%	0	0.0%	0	0.0%	0	0.0%
無回答																
男性	0	0.0%	0	0.0%	0	0.0%	0	0.0%	0	0.0%	0	0.0%	0	0.0%	0	0.0%
女性	0	0.0%	0	0.0%	0	0.0%	0	0.0%	0	0.0%	0	0.0%	0	0.0%	0	0.0%
男女合計	0	0.0%	0	0.0%	0	0.0%	0	0.0%	0	0.0%	0	0.0%	0	0.0%	0	0.0%
全体(人)																
男性	2		1		3		1		0		3		8		18	
女性	0		1		3		0		2		2		2		10	
男女合計	2		2		6		1		2		5		10		28	

相 双

	20	割合	30	割合	40	割合	50	割合	64	割合	69	割合	70～	割合	全体数	割合
1と回答																
男性	3	60.0%	2	25.0%	3	25.0%	6	40.0%	0	0.0%	2	13.3%	7	18.4%	23	22.1%
女性	2	100.0%	2	22.2%	3	30.0%	5	71.4%	3	75.0%	5	62.5%	16	80.0%	36	60.0%
男女合計	5	71.4%	4	23.5%	6	27.3%	11	50.0%	3	20.0%	7	30.4%	23	39.7%	59	36.0%
2と回答																
男性	2	40.0%	2	25.0%	7	58.3%	2	13.3%	4	36.4%	3	20.0%	20	52.6%	40	38.5%
女性	0	0.0%	4	44.4%	5	50.0%	1	14.3%	1	25.0%	1	12.5%	3	15.0%	15	25.0%
男女合計	2	28.6%	6	35.3%	12	54.5%	3	13.6%	5	33.3%	4	17.4%	23	39.7%	55	33.5%
3と回答																
男性	0	0.0%	2	25.0%	0	0.0%	4	26.7%	5	45.5%	7	46.7%	9	23.7%	27	26.0%
女性	0	0.0%	3	33.3%	1	10.0%	1	14.3%	0	0.0%	2	25.0%	1	5.0%	8	13.3%
男女合計	0	0.0%	5	29.4%	1	4.5%	5	22.7%	5	33.3%	9	39.1%	10	17.2%	35	21.3%
4と回答																
男性	0	0.0%	1	12.5%	2	16.7%	3	20.0%	2	18.2%	3	20.0%	2	5.3%	13	12.5%
女性	0	0.0%	0	0.0%	1	10.0%	0	0.0%	0	0.0%	0	0.0%	0	0.0%	1	1.7%
男女合計	0	0.0%	1	5.9%	3	13.6%	3	13.6%	2	13.3%	3	13.0%	2	3.4%	14	8.5%
無回答																
男性	0	0.0%	1	12.5%	0	0.0%	0	0.0%	0	0.0%	0	0.0%	0	0.0%	1	1.0%
女性	0	0.0%	0	0.0%	0	0.0%	0	0.0%	0	0.0%	0	0.0%	0	0.0%	0	0.0%
男女合計	0	0.0%	1	5.9%	0	0.0%	0	0.0%	0	0.0%	0	0.0%	0	0.0%	1	0.6%
全体(人)																
男性	5		8		12		15		11		15		38		104	
女性	2		9		10		7		4		8		20		60	
男女合計	7		17		22		22		15		23		58		164	

いわき

	20	割合	30	割合	40	割合	50	割合	64	割合	69	割合	70～	割合	全体数	割合
1と回答																
男性	2	33.3%	7	36.8%	4	20.0%	8	22.9%	3	9.7%	2	6.5%	17	20.0%	43	18.9%
女性	5	71.4%	5	41.7%	9	60.0%	14	46.7%	15	62.5%	9	50.0%	19	55.9%	76	54.3%
男女合計	7	53.8%	12	38.7%	13	37.1%	22	33.8%	18	32.7%	11	22.4%	36	30.3%	119	32.4%
2と回答																
男性	2	33.3%	7	36.8%	6	30.0%	9	25.7%	11	35.5%	14	45.2%	31	36.5%	80	35.2%
女性	1	14.3%	6	50.0%	5	33.3%	12	40.0%	3	12.5%	8	44.4%	11	32.4%	46	32.9%
男女合計	3	23.1%	13	41.9%	11	31.4%	21	32.3%	14	25.5%	22	44.9%	42	35.3%	126	34.3%
3と回答																
男性	1	16.7%	4	21.1%	7	35.0%	12	34.3%	13	41.9%	12	38.7%	33	38.8%	82	36.1%
女性	0	0.0%	1	8.3%	1	6.7%	4	13.3%	4	16.7%	0	0.0%	3	8.8%	13	9.3%
男女合計	1	7.7%	5	16.1%	8	22.9%	16	24.6%	17	30.9%	12	24.5%	36	30.3%	95	25.9%
4と回答																
男性	1	16.7%	1	5.3%	3	15.0%	6	17.1%	4	12.9%	3	9.7%	4	4.7%	22	9.7%
女性	1	14.3%	0	0.0%	0	0.0%	0	0.0%	2	8.3%	0	0.0%	1	2.9%	4	2.9%
男女合計	2	15.4%	1	3.2%	3	8.6%	6	9.2%	6	10.9%	3	6.1%	5	4.2%	26	7.1%
無回答																
男性	0	0.0%	0	0.0%	0	0.0%	0	0.0%	0	0.0%	0	0.0%	0	0.0%	0	0.0%
女性	0	0.0%	0	0.0%	0	0.0%	0	0.0%	0	0.0%	1	5.6%	0	0.0%	1	0.7%
男女合計	0	0.0%	0	0.0%	0	0.0%	0	0.0%	0	0.0%	1	2.0%	0	0.0%	1	0.3%
全体(人)																
男性	6		19		20		35		31		31		85		227	
女性	7		12		15		30		24		18		34		140	
男女合計	13		31		35		65		55		49		119		367	

(3) 飲酒の状況

(「(1) 飲酒の頻度」及び「(2) 飲酒の量」の回答に関するクロス集計)

	20	割合	30	割合	40	割合	50	割合	64	割合	69	割合	70	割合	80	割合	90	割合	全体数	割合
毎日、極少量お酒を飲んでいる。																				
男性	0	0.0%	2	1.0%	5	2.1%	6	1.9%	1	0.5%	1	0.5%	16	3.7%	9	4.8%	0	0.0%	40	2.1%
女性	0	0.0%	1	0.5%	4	1.5%	4	1.2%	3	1.4%	3	1.4%	12	2.8%	9	3.2%	0	0.0%	36	1.7%
男女合計	0	0.0%	3	0.8%	9	1.8%	10	1.5%	4	1.0%	4	0.9%	28	3.3%	18	3.9%	0	0.0%	76	1.9%
毎日、1合程度お酒を飲んでいる。																				
男性	0	0.0%	11	5.7%	16	6.7%	25	8.0%	21	10.7%	32	15.2%	52	12.0%	24	12.8%	2	4.7%	183	9.5%
女性	0	0.0%	7	3.8%	15	5.7%	14	4.0%	10	4.8%	10	4.5%	9	2.1%	0	0.0%	0	0.0%	65	3.1%
男女合計	0	0.0%	18	4.8%	31	6.2%	39	5.9%	31	7.7%	42	9.7%	61	7.1%	24	5.2%	2	1.7%	248	6.1%
毎日、2合程度お酒を飲んでいる。																				
男性	1	0.8%	11	5.7%	27	11.3%	54	17.3%	31	15.8%	34	16.1%	83	19.2%	20	10.7%	4	9.3%	265	13.7%
女性	1	0.8%	2	1.1%	15	5.7%	14	4.0%	6	2.9%	5	2.3%	7	1.6%	0	0.0%	0	0.0%	50	2.4%
男女合計	2	0.8%	13	3.5%	42	8.4%	68	10.3%	37	9.2%	39	9.0%	90	10.5%	20	4.3%	4	3.4%	315	7.8%
毎日、3合以上お酒を飲んでいる。																				
男性	1	0.8%	7	3.6%	12	5.0%	23	7.4%	16	8.2%	16	7.6%	16	3.7%	3	1.6%	0	0.0%	94	4.9%
女性	0	0.0%	2	1.1%	3	1.1%	2	0.6%	3	1.4%	1	0.5%	2	0.5%	0	0.0%	0	0.0%	13	0.6%
男女合計	1	0.4%	9	2.4%	15	3.0%	25	3.8%	19	4.7%	17	3.9%	18	2.1%	3	0.6%	0	0.0%	107	2.6%
毎日、お酒を飲んでいる。(飲む量未回答)																				
男性	0	0.0%	0	0.0%	0	0.0%	0	0.0%	1	0.5%	1	0.5%	2	0.5%	1	0.5%	0	0.0%	5	0.3%
女性	0	0.0%	0	0.0%	0	0.0%	0	0.0%	0	0.0%	1	0.5%	0	0.0%	1	0.4%	0	0.0%	2	0.1%
男女合計	0	0.0%	0	0.0%	0	0.0%	0	0.0%	1	0.2%	2	0.5%	2	0.2%	2	0.4%	0	0.0%	7	0.2%
週に5、6回、極少量お酒を飲んでいる。																				
男性	1	0.8%	1	0.5%	6	2.5%	1	0.3%	2	1.0%	0	0.0%	1	0.2%	3	1.6%	0	0.0%	15	0.8%
女性	0	0.0%	0	0.0%	6	2.3%	4	1.2%	2	1.0%	7	3.2%	3	0.7%	2	0.7%	0	0.0%	24	1.1%
男女合計	1	0.4%	1	0.3%	12	2.4%	5	0.8%	4	1.0%	7	1.6%	4	0.5%	5	1.1%	0	0.0%	39	1.0%
週に5、6回、1合程度お酒を飲んでいる。																				
男性	1	0.8%	8	4.2%	7	2.9%	11	3.5%	7	3.6%	7	3.3%	14	3.2%	3	1.6%	0	0.0%	58	3.0%
女性	1	0.8%	3	1.6%	4	1.5%	5	1.4%	4	1.9%	7	3.2%	7	1.6%	0	0.0%	0	0.0%	31	1.5%
男女合計	2	0.8%	11	2.9%	11	2.2%	16	2.4%	11	2.7%	14	3.2%	21	2.5%	3	0.6%	0	0.0%	89	2.2%
週に5、6回、2合程度お酒を飲んでいる。																				
男性	0	0.0%	4	2.1%	8	3.4%	11	3.5%	12	6.1%	7	3.3%	7	1.6%	2	1.1%	0	0.0%	51	2.6%
女性	0	0.0%	1	0.5%	0	0.0%	1	0.3%	2	1.0%	2	0.9%	2	0.5%	0	0.0%	0	0.0%	8	0.4%
男女合計	0	0.0%	5	1.3%	8	1.6%	12	1.8%	14	3.5%	9	2.1%	9	1.1%	2	0.4%	0	0.0%	59	1.5%
週に5、6回、3合以上お酒を飲んでいる。																				
男性	0	0.0%	3	1.6%	3	1.3%	3	1.0%	4	2.0%	4	1.9%	2	0.5%	0	0.0%	0	0.0%	19	1.0%
女性	0	0.0%	1	0.5%	0	0.0%	1	0.3%	3	1.4%	0	0.0%	0	0.0%	0	0.0%	0	0.0%	5	0.2%
男女合計	0	0.0%	4	1.1%	3	0.6%	4	0.6%	7	1.7%	4	0.9%	2	0.2%	0	0.0%	0	0.0%	24	0.6%

	20	割合	30	割合	40	割合	50	割合	64	割合	69	割合	70	割合	80	割合	90	割合	全体数	割合		
週に5、6回、お酒を飲んでいる。(飲む量未回答)																						
男性	0	0.0%	0	0.0%	1	0.4%	0	0.0%	0	0.0%	0	0.0%	0	0.0%	0	0.0%	0	0.0%	1	0.1%		
女性	0	0.0%	0	0.0%	0	0.0%	0	0.0%	0	0.0%	0	0.0%	0	0.0%	0	0.0%	0	0.0%	0	0.0%		
男女合計	0	0.0%	0	0.0%	1	0.2%	0	0.0%	0	0.0%	0	0.0%	0	0.0%	0	0.0%	0	0.0%	1	0.0%		
週に3、4回、極少量お酒を飲んでいる。																						
男性	1	0.8%	3	1.6%	1	0.4%	3	1.0%	2	1.0%	1	0.5%	5	1.2%	2	1.1%	0	0.0%	18	0.9%		
女性	0	0.0%	1	0.5%	10	3.8%	10	2.9%	11	5.3%	3	1.4%	8	1.9%	5	1.8%	1	1.4%	49	2.3%		
男女合計	1	0.4%	4	1.1%	11	2.2%	13	2.0%	13	3.2%	4	0.9%	13	1.5%	7	1.5%	1	0.9%	67	1.7%		
週に3、4回、1合程度お酒を飲んでいる。																						
男性	6	4.9%	8	4.2%	15	6.3%	11	3.5%	6	3.1%	9	4.3%	11	2.5%	7	3.7%	1	2.3%	74	3.8%		
女性	1	0.8%	3	1.6%	8	3.0%	13	3.8%	4	1.9%	6	2.7%	8	1.9%	4	1.4%	0	0.0%	47	2.2%		
男女合計	7	2.8%	11	2.9%	23	4.6%	24	3.6%	10	2.5%	15	3.5%	19	2.2%	11	2.4%	1	0.9%	121	3.0%		
週に3、4回、2合程度お酒を飲んでいる。																						
男性	4	3.3%	3	1.6%	9	3.8%	9	2.9%	6	3.1%	6	2.8%	10	2.3%	2	1.1%	1	2.3%	50	2.6%		
女性	2	1.6%	0	0.0%	3	1.1%	2	0.6%	2	1.0%	1	0.5%	1	0.2%	0	0.0%	0	0.0%	11	0.5%		
男女合計	6	2.4%	3	0.8%	12	2.4%	11	1.7%	8	2.0%	7	1.6%	11	1.3%	2	0.4%	1	0.9%	61	1.5%		
週に3、4回、3合以上お酒を飲んでいる。																						
男性	0	0.0%	1	0.5%	2	0.8%	6	1.9%	3	1.5%	2	0.9%	0	0.0%	1	0.5%	0	0.0%	15	0.8%		
女性	0	0.0%	0	0.0%	1	0.4%	0	0.0%	0	0.0%	0	0.0%	0	0.0%	0	0.0%	0	0.0%	1	0.0%		
男女合計	0	0.0%	1	0.3%	3	0.6%	6	0.9%	3	0.7%	2	0.5%	0	0.0%	1	0.2%	0	0.0%	16	0.4%		
週に3、4回、お酒を飲んでいる。(飲む量未回答)																						
男性	0	0.0%	0	0.0%	0	0.0%	1	0.3%	0	0.0%	0	0.0%	1	0.2%	0	0.0%	0	0.0%	2	0.1%		
女性	0	0.0%	0	0.0%	0	0.0%	0	0.0%	0	0.0%	0	0.0%	0	0.0%	0	0.0%	0	0.0%	0	0.0%		
男女合計	0	0.0%	0	0.0%	0	0.0%	1	0.2%	0	0.0%	0	0.0%	1	0.1%	0	0.0%	0	0.0%	2	0.0%		
たまに、極少量お酒を飲んでいる。																						
男性	27	22.0%	22	11.5%	22	9.2%	28	9.0%	11	5.6%	11	5.2%	29	6.7%	10	5.3%	5	11.6%	165	8.5%		
女性	35	28.0%	42	23.0%	46	17.4%	71	20.5%	35	16.8%	45	20.4%	67	15.8%	30	10.8%	6	8.2%	377	17.8%		
男女合計	62	25.0%	64	17.1%	68	13.5%	99	15.0%	46	11.4%	56	13.0%	96	11.2%	40	8.6%	11	9.5%	542	13.4%		
たまに、1合程度お酒を飲んでいる。																						
男性	25	20.3%	26	13.5%	28	11.8%	23	7.4%	14	7.1%	15	7.1%	31	7.2%	12	6.4%	2	4.7%	176	9.1%		
女性	14	11.2%	26	14.2%	27	10.2%	32	9.2%	11	5.3%	13	5.9%	22	5.2%	4	1.4%	0	0.0%	149	7.0%		
男女合計	39	15.7%	52	13.9%	55	11.0%	55	8.4%	25	6.2%	28	6.5%	53	6.2%	16	3.4%	2	1.7%	325	8.0%		
たまに、2合程度お酒を飲んでいる。																						
男性	9	7.3%	10	5.2%	6	2.5%	9	2.9%	9	4.6%	10	4.7%	11	2.5%	3	1.6%	0	0.0%	67	3.5%		
女性	6	4.8%	6	3.3%	6	2.3%	4	1.2%	2	1.0%	3	1.4%	5	1.2%	0	0.0%	0	0.0%	32	1.5%		
男女合計	15	6.0%	16	4.3%	12	2.4%	13	2.0%	11	2.7%	13	3.0%	16	1.9%	3	0.6%	0	0.0%	99	2.4%		
たまに、3合以上お酒を飲んでいる。																						
男性	6	4.9%	5	2.6%	3	1.3%	8	2.6%	4	2.0%	1	0.5%	1	0.2%	0	0.0%	0	0.0%	28	1.4%		
女性	3	2.4%	3	1.6%	0	0.0%	0	0.0%	1	0.5%	0	0.0%	0	0.0%	0	0.0%	0	0.0%	7	0.3%		
男女合計	9	3.6%	8	2.1%	3	0.6%	8	1.2%	5	1.2%	1	0.2%	1	0.1%	0	0.0%	0	0.0%	35	0.9%		
たまに、お酒を飲んでいる。(飲む量未回答)																						
男性	0	0.0%	1	0.5%	0	0.0%	0	0.0%	0	0.0%	0	0.0%	0	0.0%	0	0.0%	0	0.0%	1	0.1%		
女性	0	0.0%	0	0.0%	0	0.0%	0	0.0%	0	0.0%	1	0.5%	3	0.7%	1	0.4%	0	0.0%	5	0.2%		
男女合計	0	0.0%	1	0.3%	0	0.0%	0	0.0%	0	0.0%	1	0.2%	3	0.4%	1	0.2%	0	0.0%	6	0.1%		
*参考 以前は飲んでいたが、今は飲んでいない。																						
男性	3	2.4%	12	6.3%	13	5.5%	25	8.0%	10	5.1%	26	12.3%	76	17.6%	41	21.9%	13	30.2%	219	11.3%		
女性	15	12.0%	28	15.3%	30	11.4%	38	11.0%	22	10.6%	17	7.7%	30	7.1%	20	7.2%	11	15.1%	211	9.9%		
男女合計	18	7.3%	40	10.7%	43	8.6%	63	9.6%	32	7.9%	43	10.0%	106	12.4%	61	13.1%	24	20.7%	430	10.6%		
*参考 もともと飲まない。																						
男性	38	30.9%	54	28.1%	54	22.7%	54	17.3%	36	18.4%	26	12.3%	57	13.2%	38	20.3%	14	32.6%	371	19.2%		
女性	47	37.6%	57	31.1%	86	32.6%	131	37.9%	86	41.3%	96	43.4%	221	52.0%	182	65.7%	54	74.0%	960	45.2%		
男女合計	85	34.3%	111	29.6%	140	27.9%	185	28.1%	122	30.2%	122	28.2%	278	32.4%	220	47.4%	68	58.6%	1331	32.8%		
無回答																						
男性	0	0.0%	0	0.0%	0	0.0%	1	0.3%	0	0.0%	2	0.9%	7	1.6%	6	3.2%	1	2.3%	17	0.9%		
女性	0	0.0%	0	0.0%	0	0.0%	0	0.0%	1	0.5%	0	0.0%	18	4.2%	19	6.9%	1	1.4%	39	1.8%		
男女合計	0	0.0%	0	0.0%	0	0.0%	1	0.2%	1	0.2%	2	0.5%	25	2.9%	25	5.4%	2	1.7%	56	1.4%		
全体(人)																						
男性	123		192		238		312		196		211		432		187		43		1934			
女性	125		183		264		346		208		221		425		277		73		2122			
男女合計	248		375		502		658		404		432		857		464		116		4056			

16 定期的な歯科健診の状況（調査票 問16）

問16 あなたは定期的に歯科健診（歯石の除去、歯面清掃を含む）を受けていますか。

1 はい 2 いいえ

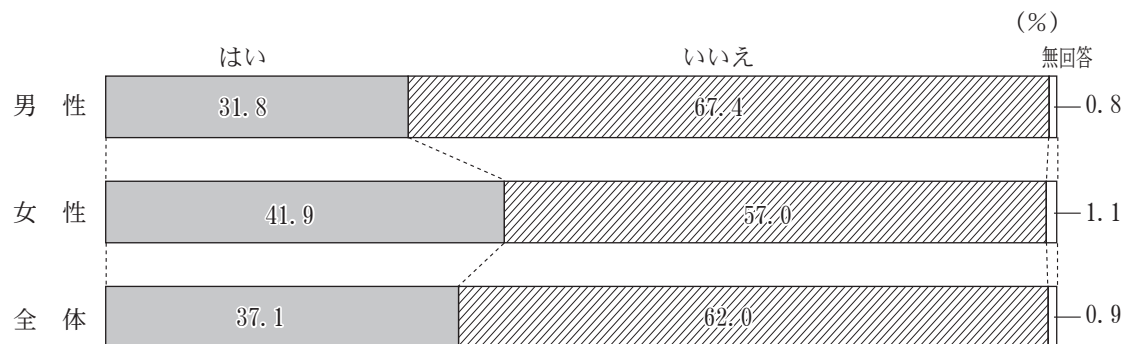

	10	割合	20	割合	30	割合	40	割合	50	割合	64	割合	69	割合	70	割合	80	割合	90	割合	全体数	割合
1と回答																						
男性	28	34.1%	27	22.0%	40	20.8%	75	31.5%	102	32.7%	71	36.2%	83	39.3%	161	37.3%	47	25.1%	7	16.3%	641	31.8%
女性	35	47.3%	45	36.0%	88	48.1%	127	48.1%	169	48.8%	93	44.7%	97	43.9%	176	41.4%	79	28.5%	12	16.4%	921	41.9%
男女合計	63	40.4%	72	29.0%	128	34.1%	202	40.2%	271	41.2%	164	40.6%	180	41.7%	337	39.3%	126	27.2%	19	16.4%	1562	37.1%
2と回答																						
男性	48	58.5%	96	78.0%	152	79.2%	163	68.5%	209	67.0%	125	63.8%	128	60.7%	264	61.1%	138	73.8%	36	83.7%	1359	67.4%
女性	38	51.4%	80	64.0%	95	51.9%	137	51.9%	176	50.9%	114	54.8%	124	56.1%	242	56.9%	187	67.5%	58	79.5%	1251	57.0%
男女合計	86	55.1%	176	71.0%	247	65.9%	300	59.8%	385	58.5%	239	59.2%	252	58.3%	506	59.0%	325	70.0%	94	81.0%	2610	62.0%
無回答																						
男性	6	7.3%	0	0.0%	0	0.0%	0	0.0%	1	0.3%	0	0.0%	0	0.0%	7	1.6%	2	1.1%	0	0.0%	16	0.8%
女性	1	1.4%	0	0.0%	0	0.0%	0	0.0%	1	0.3%	1	0.5%	0	0.0%	7	1.6%	11	4.0%	3	4.1%	24	1.1%
男女合計	7	4.5%	0	0.0%	0	0.0%	0	0.0%	2	0.3%	1	0.2%	0	0.0%	14	1.6%	13	2.8%	3	2.6%	40	0.9%
全体(人)																						
男性	82		123		192		238		312		196		211		432		187		43		2016	
女性	74		125		183		264		346		208		221		425		277		73		2196	
男女合計	156		248		375		502		658		404		432		857		464		116		4212	

県 北

	10	割合	20	割合	30	割合	40	割合	50	割合	64	割合	69	割合	70～	割合	全体数	割合
1と回答																		
男性	5	20.8%	7	14.9%	14	31.8%	14	24.6%	25	28.7%	16	32.7%	25	48.1%	45	31.9%	151	30.1%
女性	7	46.7%	19	42.2%	20	44.4%	32	46.4%	50	47.2%	19	43.2%	23	41.8%	67	35.4%	237	41.7%
男女合計	12	30.8%	26	28.3%	34	38.2%	46	36.5%	75	38.9%	35	37.6%	48	44.9%	112	33.9%	388	36.3%
2と回答																		
男性	18	75.0%	40	85.1%	30	68.2%	43	75.4%	61	70.1%	33	67.3%	27	51.9%	95	67.4%	347	69.3%
女性	8	53.3%	26	57.8%	25	55.6%	37	53.6%	55	51.9%	25	56.8%	32	58.2%	114	60.3%	322	56.7%
男女合計	26	66.7%	66	71.7%	55	61.8%	80	63.5%	116	60.1%	58	62.4%	59	55.1%	209	63.3%	669	62.6%
無回答																		
男性	1	4.2%	0	0.0%	0	0.0%	0	0.0%	1	1.1%	0	0.0%	0	0.0%	1	0.7%	3	0.6%
女性	0	0.0%	0	0.0%	0	0.0%	0	0.0%	1	0.9%	0	0.0%	0	0.0%	8	4.2%	9	1.6%
男女合計	1	2.6%	0	0.0%	0	0.0%	0	0.0%	2	1.0%	0	0.0%	0	0.0%	9	2.7%	12	1.1%
全体(人)																		
男性	24		47		44		57		87		49		52		141		501	
女性	15		45		45		69		106		44		55		189		568	
男女合計	39		92		89		126		193		93		107		330		1069	

県 中

	10	割合	20	割合	30	割合	40	割合	50	割合	64	割合	69	割合	70～	割合	全体数	割合
1と回答																		
男性	8	38.1%	8	25.0%	14	27.5%	21	31.8%	33	37.5%	25	53.2%	15	34.1%	37	25.9%	161	32.7%
女性	10	50.0%	13	35.1%	26	48.1%	42	57.5%	36	45.6%	24	48.0%	19	43.2%	54	34.2%	224	43.5%
男女合計	18	43.9%	21	30.4%	40	38.1%	63	45.3%	69	41.3%	49	50.5%	34	38.6%	91	30.2%	385	38.2%
2と回答																		
男性	10	47.6%	24	75.0%	37	72.5%	45	68.2%	55	62.5%	22	46.8%	29	65.9%	103	72.0%	325	66.1%
女性	10	50.0%	24	64.9%	28	51.9%	31	42.5%	43	54.4%	26	52.0%	25	56.8%	101	63.9%	288	55.9%
男女合計	20	48.8%	48	69.6%	65	61.9%	76	54.7%	98	58.7%	48	49.5%	54	61.4%	204	67.8%	613	60.9%
無回答																		
男性	3	14.3%	0	0.0%	0	0.0%	0	0.0%	0	0.0%	0	0.0%	0	0.0%	3	2.1%	6	1.2%
女性	0	0.0%	0	0.0%	0	0.0%	0	0.0%	0	0.0%	0	0.0%	0	0.0%	3	1.9%	3	0.6%
男女合計	3	7.3%	0	0.0%	0	0.0%	0	0.0%	0	0.0%	0	0.0%	0	0.0%	6	2.0%	9	0.9%
全体(人)																		
男性	21		32		51		66		88		47		44		143		492	
女性	20		37		54		73		79		50		44		158		515	
男女合計	41		69		105		139		167		97		88		301		1007	

県 南

	10	割合	20	割合	30	割合	40	割合	50	割合	64	割合	69	割合	70～	割合	全体数	割合
1と回答																		
男性	4	33.3%	1	14.3%	1	5.0%	6	28.6%	9	26.5%	7	33.3%	8	38.1%	30	38.0%	66	30.7%
女性	7	70.0%	3	27.3%	9	60.0%	10	35.7%	21	60.0%	9	34.6%	8	33.3%	32	33.0%	99	40.2%
男女合計	11	50.0%	4	22.2%	10	28.6%	16	32.7%	30	43.5%	16	34.0%	16	35.6%	62	35.2%	165	35.8%
2と回答																		
男性	8	66.7%	6	85.7%	19	95.0%	15	71.4%	25	73.5%	14	66.7%	13	61.9%	46	58.2%	146	67.9%
女性	3	30.0%	8	72.7%	6	40.0%	18	64.3%	14	40.0%	17	65.4%	16	66.7%	61	62.9%	143	58.1%
男女合計	11	50.0%	14	77.8%	25	71.4%	33	67.3%	39	56.5%	31	66.0%	29	64.4%	107	60.8%	289	62.7%
無回答																		
男性	0	0.0%	0	0.0%	0	0.0%	0	0.0%	0	0.0%	0	0.0%	0	0.0%	3	3.8%	3	1.4%
女性	0	0.0%	0	0.0%	0	0.0%	0	0.0%	0	0.0%	0	0.0%	0	0.0%	4	4.1%	4	1.6%
男女合計	0	0.0%	0	0.0%	0	0.0%	0	0.0%	0	0.0%	0	0.0%	0	0.0%	7	4.0%	7	1.5%
全体(人)																		
男性	12		7		20		21		34		21		21		79		215	
女性	10		11		15		28		35		26		24		97		246	
男女合計	22		18		35		49		69		47		45		176		461	

会 津

	10	割合	20	割合	30	割合	40	割合	50	割合	64	割合	69	割合	70～	割合	全体数	割合
1と回答																		
男性	1	16.7%	4	22.2%	5	17.9%	12	27.9%	9	28.1%	2	9.1%	12	48.0%	34	34.3%	79	28.9%
女性	2	28.6%	2	18.2%	10	40.0%	17	44.7%	17	40.5%	14	50.0%	14	43.8%	38	32.5%	114	38.0%
男女合計	3	23.1%	6	20.7%	15	28.3%	29	35.8%	26	35.1%	16	32.0%	26	45.6%	72	33.3%	193	33.7%
2と回答																		
男性	5	83.3%	14	77.8%	23	82.1%	31	72.1%	23	71.9%	20	90.9%	13	52.0%	65	65.7%	194	71.1%
女性	5	71.4%	9	81.8%	15	60.0%	21	55.3%	25	59.5%	14	50.0%	18	56.3%	77	65.8%	184	61.3%
男女合計	10	76.9%	23	79.3%	38	71.7%	52	64.2%	48	64.9%	34	68.0%	31	54.4%	142	65.7%	378	66.0%
無回答																		
男性	0	0.0%	0	0.0%	0	0.0%	0	0.0%	0	0.0%	0	0.0%	0	0.0%	0	0.0%	0	0.0%
女性	0	0.0%	0	0.0%	0	0.0%	0	0.0%	0	0.0%	0	0.0%	0	0.0%	2	1.7%	2	0.7%
男女合計	0	0.0%	0	0.0%	0	0.0%	0	0.0%	0	0.0%	0	0.0%	0	0.0%	2	0.9%	2	0.3%
全体(人)																		
男性	6		18		28		43		32		22		25		99		273	
女性	7		11		25		38		42		28		32		117		300	
男女合計	13		29		53		81		74		50		57		216		573	

南会津

	10	割合	20	割合	30	割合	40	割合	50	割合	64	割合	69	割合	70～	割合	全体数	割合
1と回答																		
男性	0	0.0%	0	0.0%	0	0.0%	0	0.0%	0	0.0%	0	0.0%	2	50.0%	5	35.7%	7	23.3%
女性	0	0.0%	0	0.0%	0	0.0%	2	66.7%	0	0.0%	1	33.3%	0	0.0%	5	38.5%	8	30.8%
男女合計	0	0.0%	0	0.0%	0	0.0%	2	33.3%	0	0.0%	1	25.0%	2	25.0%	10	37.0%	15	26.8%
2と回答																		
男性	0	0.0%	3	100.0%	2	100.0%	3	100.0%	3	100.0%	1	100.0%	2	50.0%	9	64.3%	23	76.7%
女性	0	0.0%	0	0.0%	2	100.0%	1	33.3%	1	100.0%	2	66.7%	4	100.0%	8	61.5%	18	69.2%
男女合計	0	0.0%	3	100.0%	4	100.0%	4	66.7%	4	100.0%	3	75.0%	6	75.0%	17	63.0%	41	73.2%
無回答																		
男性	0	0.0%	0	0.0%	0	0.0%	0	0.0%	0	0.0%	0	0.0%	0	0.0%	0	0.0%	0	0.0%
女性	0	0.0%	0	0.0%	0	0.0%	0	0.0%	0	0.0%	0	0.0%	0	0.0%	0	0.0%	0	0.0%
男女合計	0	0.0%	0	0.0%	0	0.0%	0	0.0%	0	0.0%	0	0.0%	0	0.0%	0	0.0%	0	0.0%
全体(人)																		
男性	0		3		2		3		3		1		4		14		30	
女性	0		0		2		3		1		3		4		13		26	
男女合計	0		3		4		6		4		4		8		27		56	

相 双

	10	割合	20	割合	30	割合	40	割合	50	割合	64	割合	69	割合	70～	割合	全体数	割合
1と回答																		
男性	1	16.7%	3	50.0%	3	25.0%	7	38.9%	10	50.0%	6	42.9%	3	15.0%	21	36.8%	54	35.3%
女性	2	33.3%	2	50.0%	9	64.3%	8	33.3%	14	70.0%	3	27.3%	12	63.2%	19	31.7%	69	43.7%
男女合計	3	25.0%	5	50.0%	12	46.2%	15	35.7%	24	60.0%	9	36.0%	15	38.5%	40	34.2%	123	39.5%
2と回答																		
男性	4	66.7%	3	50.0%	9	75.0%	11	61.1%	10	50.0%	8	57.1%	17	85.0%	35	61.4%	97	63.4%
女性	3	50.0%	2	50.0%	5	35.7%	16	66.7%	6	30.0%	8	72.7%	7	36.8%	38	63.3%	85	53.8%
男女合計	7	58.3%	5	50.0%	14	53.8%	27	64.3%	16	40.0%	16	64.0%	24	61.5%	73	62.4%	182	58.5%
無回答																		
男性	1	16.7%	0	0.0%	0	0.0%	0	0.0%	0	0.0%	0	0.0%	0	0.0%	1	1.8%	2	1.3%
女性	1	16.7%	0	0.0%	0	0.0%	0	0.0%	0	0.0%	0	0.0%	0	0.0%	3	5.0%	4	2.5%
男女合計	2	16.7%	0	0.0%	0	0.0%	0	0.0%	0	0.0%	0	0.0%	0	0.0%	4	3.4%	6	1.9%
全体(人)																		
男性	6		6		12		18		20		14		20		57		153	
女性	6		4		14		24		20		11		19		60		158	
男女合計	12		10		26		42		40		25		39		117		311	

いわき

	10	割合	20	割合	30	割合	40	割合	50	割合	64	割合	69	割合	70～	割合	全体数	割合
1と回答																		
男性	9	69.2%	4	40.0%	3	8.6%	15	50.0%	16	33.3%	15	35.7%	18	40.0%	43	33.3%	123	34.9%
女性	7	43.8%	6	35.3%	14	50.0%	16	55.2%	31	49.2%	23	50.0%	21	48.8%	52	36.9%	170	44.4%
男女合計	16	55.2%	10	37.0%	17	27.0%	31	52.5%	47	42.3%	38	43.2%	39	44.3%	95	35.2%	293	39.9%
2と回答																		
男性	3	23.1%	6	60.0%	32	91.4%	15	50.0%	32	66.7%	27	64.3%	27	60.0%	85	65.9%	227	64.5%
女性	9	56.3%	11	64.7%	14	50.0%	13	44.8%	32	50.8%	22	47.8%	22	51.2%	88	62.4%	211	55.1%
男女合計	12	41.4%	17	63.0%	46	73.0%	28	47.5%	64	57.7%	49	55.7%	49	55.7%	173	64.1%	438	59.6%
無回答																		
男性	1	7.7%	0	0.0%	0	0.0%	0	0.0%	0	0.0%	0	0.0%	0	0.0%	1	0.8%	2	0.6%
女性	0	0.0%	0	0.0%	0	0.0%	0	0.0%	0	0.0%	1	2.2%	0	0.0%	1	0.7%	2	0.5%
男女合計	1	3.4%	0	0.0%	0	0.0%	0	0.0%	0	0.0%	1	1.1%	0	0.0%	2	0.7%	4	0.5%
全体(人)																		
男性	13		10		35		30		48		42		45		129		352	
女性	16		17		28		29		63		46		43		141		383	
男女合計	29		27		63		59		111		88		88		270		735	

全県 (60歳以上・再掲)

	64	割合	69	割合	70	割合	80	割合	90	割合	全体数	割合
1と回答												
男性	71	36.2%	83	39.3%	161	37.3%	47	25.1%	7	16.3%	369	34.5%
女性	93	44.7%	97	43.9%	176	41.4%	79	28.5%	12	16.4%	457	38.0%
男女合計	164	40.6%	180	41.7%	337	39.3%	126	27.2%	19	16.4%	826	36.3%
2と回答												
男性	125	63.8%	128	60.7%	264	61.1%	138	73.8%	36	83.7%	691	64.6%
女性	114	54.8%	124	56.1%	242	56.9%	187	67.5%	58	79.5%	725	60.2%
男女合計	239	59.2%	252	58.3%	506	59.0%	325	70.0%	94	81.0%	1416	62.3%
無回答												
男性	0	0.0%	0	0.0%	7	1.6%	2	1.1%	0	0.0%	9	0.8%
女性	1	0.5%	0	0.0%	7	1.6%	11	4.0%	3	4.1%	22	1.8%
男女合計	1	0.2%	0	0.0%	14	1.6%	13	2.8%	3	2.6%	31	1.4%
全体(人)												
男性	196		211		432		187		43		1069	
女性	208		221		425		277		73		1204	
男女合計	404		432		857		464		116		2273	

17 歯みがきの状況（調査票 問17）

問17 あなたは、毎食後（1日3回以上）歯をみがいていますか。

1 はい 2 いいえ

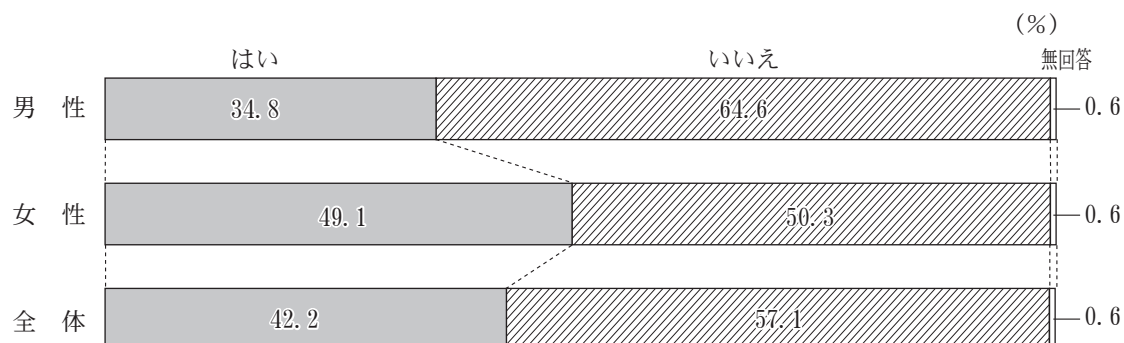

	10	割合	20	割合	30	割合	40	割合	50	割合	64	割合	69	割合	70	割合	80	割合	90	割合	全体数	割合
1と回答																						
男性	24	29.3%	45	36.6%	56	29.2%	78	32.8%	112	35.9%	64	32.7%	71	33.6%	165	38.2%	76	40.6%	10	23.3%	701	34.8%
女性	42	56.8%	62	49.6%	85	46.4%	126	47.7%	187	54.0%	99	47.6%	115	52.0%	210	49.4%	121	43.7%	31	42.5%	1078	49.1%
男女合計	66	42.3%	107	43.1%	141	37.6%	204	40.6%	299	45.4%	163	40.3%	186	43.1%	375	43.8%	197	42.5%	41	35.3%	1779	42.2%
2と回答																						
男性	53	64.6%	78	63.4%	136	70.8%	160	67.2%	199	63.8%	132	67.3%	140	66.4%	262	60.6%	109	58.3%	33	76.7%	1302	64.6%
女性	32	43.2%	62	49.6%	98	53.6%	138	52.3%	158	45.7%	108	51.9%	106	48.0%	212	49.9%	151	54.5%	40	54.8%	1105	50.3%
男女合計	85	54.5%	140	56.5%	234	62.4%	298	59.4%	357	54.3%	240	59.4%	246	56.9%	474	55.3%	260	56.0%	73	62.9%	2407	57.1%
無回答																						
男性	5	6.1%	0	0.0%	0	0.0%	0	0.0%	1	0.3%	0	0.0%	0	0.0%	5	1.2%	2	1.1%	0	0.0%	13	0.6%
女性	0	0.0%	1	0.8%	0	0.0%	0	0.0%	1	0.3%	1	0.5%	0	0.0%	3	0.7%	5	1.8%	2	2.7%	13	0.6%
男女合計	5	3.2%	1	0.4%	0	0.0%	0	0.0%	2	0.3%	1	0.2%	0	0.0%	8	0.9%	7	1.5%	2	1.7%	26	0.6%
全体(人)																						
男性	82		123		192		238		312		196		211		432		187		43		2016	
女性	74		125		183		264		346		208		221		425		277		73		2196	
男女合計	156		248		375		502		658		404		432		857		464		116		4212	

県 北

	10	割合	20	割合	30	割合	40	割合	50	割合	64	割合	69	割合	70～	割合	全体数	割合
1と回答																		
男性	9	37.5%	15	31.9%	15	34.1%	20	35.1%	41	47.1%	17	34.7%	21	40.4%	47	33.3%	185	36.9%
女性	10	66.7%	23	51.1%	21	46.7%	36	52.2%	54	50.9%	24	54.5%	23	41.8%	93	49.2%	284	50.0%
男女合計	19	48.7%	38	41.3%	36	40.4%	56	44.4%	95	49.2%	41	44.1%	44	41.1%	140	42.4%	469	43.9%
2と回答																		
男性	14	58.3%	32	68.1%	29	65.9%	37	64.9%	45	51.7%	32	65.3%	31	59.6%	93	66.0%	313	62.5%
女性	5	33.3%	21	46.7%	24	53.3%	33	47.8%	51	48.1%	20	45.5%	32	58.2%	94	49.7%	280	49.3%
男女合計	19	48.7%	53	57.6%	53	59.6%	70	55.6%	96	49.7%	52	55.9%	63	58.9%	187	56.7%	593	55.5%
無回答																		
男性	1	4.2%	0	0.0%	0	0.0%	0	0.0%	1	1.1%	0	0.0%	0	0.0%	1	0.7%	3	0.6%
女性	0	0.0%	1	2.2%	0	0.0%	0	0.0%	1	0.9%	0	0.0%	0	0.0%	2	1.1%	4	0.7%
男女合計	1	2.6%	1	1.1%	0	0.0%	0	0.0%	2	1.0%	0	0.0%	0	0.0%	3	0.9%	7	0.7%
全体(人)																		
男性	24		47		44		57		87		49		52		141		501	
女性	15		45		45		69		106		44		55		189		568	
男女合計	39		92		89		126		193		93		107		330		1069	

県 中

	10	割合	20	割合	30	割合	40	割合	50	割合	64	割合	69	割合	70～	割合	全体数	割合
1と回答																		
男性	4	19.0%	12	37.5%	12	23.5%	22	33.3%	27	30.7%	18	38.3%	12	27.3%	48	33.6%	155	31.5%
女性	13	65.0%	14	37.8%	27	50.0%	37	50.7%	45	57.0%	23	46.0%	24	54.5%	60	38.0%	243	47.2%
男女合計	17	41.5%	26	37.7%	39	37.1%	59	42.4%	72	43.1%	41	42.3%	36	40.9%	108	35.9%	398	39.5%
2と回答																		
男性	14	66.7%	20	62.5%	39	76.5%	44	66.7%	61	69.3%	29	61.7%	32	72.7%	94	65.7%	333	67.7%
女性	7	35.0%	23	62.2%	27	50.0%	36	49.3%	34	43.0%	27	54.0%	20	45.5%	97	61.4%	271	52.6%
男女合計	21	51.2%	43	62.3%	66	62.9%	80	57.6%	95	56.9%	56	57.7%	52	59.1%	191	63.5%	604	60.0%
無回答																		
男性	3	14.3%	0	0.0%	0	0.0%	0	0.0%	0	0.0%	0	0.0%	0	0.0%	1	0.7%	4	0.8%
女性	0	0.0%	0	0.0%	0	0.0%	0	0.0%	0	0.0%	0	0.0%	0	0.0%	1	0.6%	1	0.2%
男女合計	3	7.3%	0	0.0%	0	0.0%	0	0.0%	0	0.0%	0	0.0%	0	0.0%	2	0.7%	5	0.5%
全体(人)																		
男性	21		32		51		66		88		47		44		143		492	
女性	20		37		54		73		79		50		44		158		515	
男女合計	41		69		105		139		167		97		88		301		1007	

県 南

	10	割合	20	割合	30	割合	40	割合	50	割合	64	割合	69	割合	70～	割合	全体数	割合
1と回答																		
男性	4	33.3%	0	0.0%	3	15.0%	7	33.3%	7	20.6%	6	28.6%	7	33.3%	31	39.2%	65	30.2%
女性	6	60.0%	7	63.6%	9	60.0%	15	53.6%	20	57.1%	12	46.2%	14	58.3%	48	49.5%	131	53.3%
男女合計	10	45.5%	7	38.9%	12	34.3%	22	44.9%	27	39.1%	18	38.3%	21	46.7%	79	44.9%	196	42.5%
2と回答																		
男性	8	66.7%	7	100.0%	17	85.0%	14	66.7%	27	79.4%	15	71.4%	14	66.7%	46	58.2%	148	68.8%
女性	4	40.0%	4	36.4%	6	40.0%	13	46.4%	15	42.9%	14	53.8%	10	41.7%	46	47.4%	112	45.5%
男女合計	12	54.5%	11	61.1%	23	65.7%	27	55.1%	42	60.9%	29	61.7%	24	53.3%	92	52.3%	260	56.4%
無回答																		
男性	0	0.0%	0	0.0%	0	0.0%	0	0.0%	0	0.0%	0	0.0%	0	0.0%	2	2.5%	2	0.9%
女性	0	0.0%	0	0.0%	0	0.0%	0	0.0%	0	0.0%	0	0.0%	0	0.0%	3	3.1%	3	1.2%
男女合計	0	0.0%	0	0.0%	0	0.0%	0	0.0%	0	0.0%	0	0.0%	0	0.0%	5	2.8%	5	1.1%
全体(人)																		
男性	12		7		20		21		34		21		21		79		215	
女性	10		11		15		28		35		26		24		97		246	
男女合計	22		18		35		49		69		47		45		176		461	

会 津

	10	割合	20	割合	30	割合	40	割合	50	割合	64	割合	69	割合	70～	割合	全体数	割合
1と回答																		
男性	2	33.3%	7	38.9%	10	35.7%	19	44.2%	14	43.8%	6	27.3%	5	20.0%	42	42.4%	105	38.5%
女性	2	28.6%	6	54.5%	13	52.0%	15	39.5%	22	52.4%	17	60.7%	15	46.9%	53	45.3%	143	47.7%
男女合計	4	30.8%	13	44.8%	23	43.4%	34	42.0%	36	48.6%	23	46.0%	20	35.1%	95	44.0%	248	43.3%
2と回答																		
男性	4	66.7%	11	61.1%	18	64.3%	24	55.8%	18	56.3%	16	72.7%	20	80.0%	57	57.6%	168	61.5%
女性	5	71.4%	5	45.5%	12	48.0%	23	60.5%	20	47.6%	11	39.3%	17	53.1%	64	54.7%	157	52.3%
男女合計	9	69.2%	16	55.2%	30	56.6%	47	58.0%	38	51.4%	27	54.0%	37	64.9%	121	56.0%	325	56.7%
無回答																		
男性	0	0.0%	0	0.0%	0	0.0%	0	0.0%	0	0.0%	0	0.0%	0	0.0%	0	0.0%	0	0.0%
女性	0	0.0%	0	0.0%	0	0.0%	0	0.0%	0	0.0%	0	0.0%	0	0.0%	0	0.0%	0	0.0%
男女合計	0	0.0%	0	0.0%	0	0.0%	0	0.0%	0	0.0%	0	0.0%	0	0.0%	0	0.0%	0	0.0%
全体(人)																		
男性	6		18		28		43		32		22		25		99		273	
女性	7		11		25		38		42		28		32		117		300	
男女合計	13		29		53		81		74		50		57		216		573	

南会津

	10	割合	20	割合	30	割合	40	割合	50	割合	64	割合	69	割合	70～	割合	全体数	割合
1と回答																		
男性	0	0.0%	1	33.3%	0	0.0%	1	33.3%	2	66.7%	0	0.0%	2	50.0%	10	71.4%	16	53.3%
女性	0	0.0%	0	0.0%	0	0.0%	1	33.3%	1	100.0%	1	33.3%	4	100.0%	7	53.8%	14	53.8%
男女合計	0	0.0%	1	33.3%	0	0.0%	2	33.3%	3	75.0%	1	25.0%	6	75.0%	17	63.0%	30	53.6%
2と回答																		
男性	0	0.0%	2	66.7%	2	100.0%	2	66.7%	1	33.3%	1	100.0%	2	50.0%	4	28.6%	14	46.7%
女性	0	0.0%	0	0.0%	2	100.0%	2	66.7%	0	0.0%	2	66.7%	0	0.0%	5	38.5%	11	42.3%
男女合計	0	0.0%	2	66.7%	4	100.0%	4	66.7%	1	25.0%	3	75.0%	2	25.0%	9	33.3%	25	44.6%
無回答																		
男性	0	0.0%	0	0.0%	0	0.0%	0	0.0%	0	0.0%	0	0.0%	0	0.0%	0	0.0%	0	0.0%
女性	0	0.0%	0	0.0%	0	0.0%	0	0.0%	0	0.0%	0	0.0%	0	0.0%	1	7.7%	1	3.8%
男女合計	0	0.0%	0	0.0%	0	0.0%	0	0.0%	0	0.0%	0	0.0%	0	0.0%	1	3.7%	1	1.8%
全体(人)																		
男性	0		3		2		3		3		1		4		14		30	
女性	0		0		2		3		1		3		4		13		26	
男女合計	0		3		4		6		4		4		8		27		56	

相 双

	10	割合	20	割合	30	割合	40	割合	50	割合	64	割合	69	割合	70～	割合	全体数	割合
1と回答																		
男性	3	50.0%	3	50.0%	3	25.0%	2	11.1%	5	25.0%	4	28.6%	7	35.0%	22	38.6%	49	32.0%
女性	4	66.7%	2	50.0%	6	42.9%	10	41.7%	7	35.0%	4	36.4%	13	68.4%	32	53.3%	78	49.4%
男女合計	7	58.3%	5	50.0%	9	34.6%	12	28.6%	12	30.0%	8	32.0%	20	51.3%	54	46.2%	127	40.8%
2と回答																		
男性	3	50.0%	3	50.0%	9	75.0%	16	88.9%	15	75.0%	10	71.4%	13	65.0%	34	59.6%	103	67.3%
女性	2	33.3%	2	50.0%	8	57.1%	14	58.3%	13	65.0%	7	63.6%	6	31.6%	26	43.3%	78	49.4%
男女合計	5	41.7%	5	50.0%	17	65.4%	30	71.4%	28	70.0%	17	68.0%	19	48.7%	60	51.3%	181	58.2%
無回答																		
男性	0	0.0%	0	0.0%	0	0.0%	0	0.0%	0	0.0%	0	0.0%	0	0.0%	1	1.8%	1	0.7%
女性	0	0.0%	0	0.0%	0	0.0%	0	0.0%	0	0.0%	0	0.0%	0	0.0%	2	3.3%	2	1.3%
男女合計	0	0.0%	0	0.0%	0	0.0%	0	0.0%	0	0.0%	0	0.0%	0	0.0%	3	2.6%	3	1.0%
全体(人)																		
男性	6		6		12		18		20		14		20		57		153	
女性	6		4		14		24		20		11		19		60		158	
男女合計	12		10		26		42		40		25		39		117		311	

いわき

	10	割合	20	割合	30	割合	40	割合	50	割合	64	割合	69	割合	70～	割合	全体数	割合
1と回答																		
男性	2	15.4%	7	70.0%	13	37.1%	7	23.3%	16	33.3%	13	31.0%	17	37.8%	51	39.5%	126	35.8%
女性	7	43.8%	10	58.8%	9	32.1%	12	41.4%	38	60.3%	18	39.1%	22	51.2%	69	48.9%	185	48.3%
男女合計	9	31.0%	17	63.0%	22	34.9%	19	32.2%	54	48.6%	31	35.2%	39	44.3%	120	44.4%	311	42.3%
2と回答																		
男性	10	76.9%	3	30.0%	22	62.9%	23	76.7%	32	66.7%	29	69.0%	28	62.2%	76	58.9%	223	63.4%
女性	9	56.3%	7	41.2%	19	67.9%	17	58.6%	25	39.7%	27	58.7%	21	48.8%	71	50.4%	196	51.2%
男女合計	19	65.5%	10	37.0%	41	65.1%	40	67.8%	57	51.4%	56	63.6%	49	55.7%	147	54.4%	419	57.0%
無回答																		
男性	1	7.7%	0	0.0%	0	0.0%	0	0.0%	0	0.0%	0	0.0%	0	0.0%	2	1.6%	3	0.9%
女性	0	0.0%	0	0.0%	0	0.0%	0	0.0%	0	0.0%	1	2.2%	0	0.0%	1	0.7%	2	0.5%
男女合計	1	3.4%	0	0.0%	0	0.0%	0	0.0%	0	0.0%	1	1.1%	0	0.0%	3	1.1%	5	0.7%
全体(人)																		
男性	13		10		35		30		48		42		45		129		352	
女性	16		17		28		29		63		46		43		141		383	
男女合計	29		27		63		59		111		88		88		270		735	

全県(60歳以上・再掲)

	64	割合	69	割合	70	割合	80	割合	90	割合	全体数	割合
1と回答												
男性	64	32.7%	71	33.6%	165	38.2%	76	40.6%	10	23.3%	386	36.1%
女性	99	47.6%	115	52.0%	210	49.4%	121	43.7%	31	42.5%	576	47.8%
男女合計	163	40.3%	186	43.1%	375	43.8%	197	42.5%	41	35.3%	962	42.3%
2と回答												
男性	132	67.3%	140	66.4%	262	60.6%	109	58.3%	33	76.7%	676	63.2%
女性	108	51.9%	106	48.0%	212	49.9%	151	54.5%	40	54.8%	617	51.2%
男女合計	240	59.4%	246	56.9%	474	55.3%	260	56.0%	73	62.9%	1293	56.9%
無回答												
男性	0	0.0%	0	0.0%	5	1.2%	2	1.1%	0	0.0%	7	0.7%
女性	1	0.5%	0	0.0%	3	0.7%	5	1.8%	2	2.7%	11	0.9%
男女合計	1	0.2%	0	0.0%	8	0.9%	7	1.5%	2	1.7%	18	0.8%
全体(人)												
男性	196		211		432		187		43		1069	
女性	208		221		425		277		73		1204	
男女合計	404		432		857		464		116		2273	

18 外出の状況（調査票 問18）

問18 あなたは、積極的に外出するほうですか。
 （外出には日常生活の中での買物や散歩を含めます）

1 はい 2 いいえ

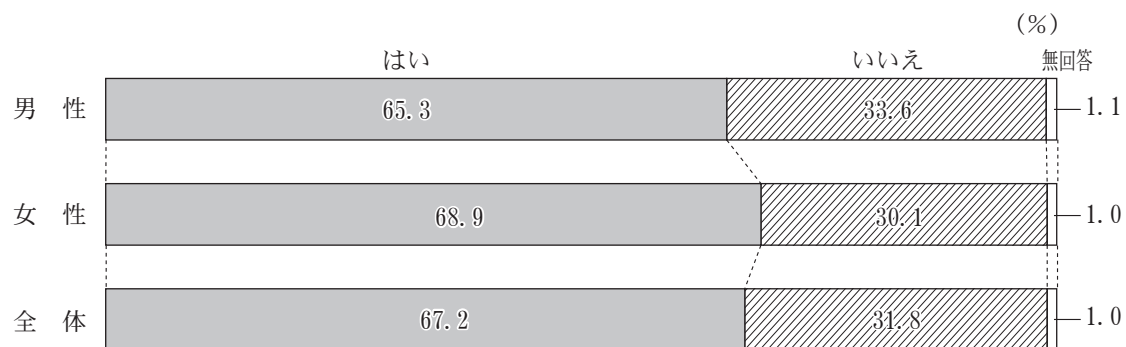

	10	割合	20	割合	30	割合	40	割合	50	割合	64	割合	69	割合	70	割合	80	割合	90	割合	全体数	割合
1と回答																						
男性	45	54.9%	78	63.4%	127	66.1%	158	66.4%	207	66.3%	138	70.4%	150	71.1%	295	68.3%	107	57.2%	12	27.9%	1317	65.3%
女性	42	56.8%	87	69.6%	143	78.1%	182	68.9%	253	73.1%	148	71.2%	170	76.9%	317	74.6%	157	56.7%	13	17.8%	1512	68.9%
男女合計	87	55.8%	165	66.5%	270	72.0%	340	67.7%	460	69.9%	286	70.8%	320	74.1%	612	71.4%	264	56.9%	25	21.6%	2829	67.2%
2と回答																						
男性	37	45.1%	42	34.1%	65	33.9%	80	33.6%	101	32.4%	56	28.6%	60	28.4%	132	30.6%	74	39.6%	30	69.8%	677	33.6%
女性	32	43.2%	38	30.4%	40	21.9%	82	31.1%	91	26.3%	58	27.9%	50	22.6%	103	24.2%	111	40.1%	57	78.1%	662	30.1%
男女合計	69	44.2%	80	32.3%	105	28.0%	162	32.3%	192	29.2%	114	28.2%	110	25.5%	235	27.4%	185	39.9%	87	75.0%	1339	31.8%
無回答																						
男性	0	0.0%	3	2.4%	0	0.0%	0	0.0%	4	1.3%	2	1.0%	1	0.5%	5	1.2%	6	3.2%	1	2.3%	22	1.1%
女性	0	0.0%	0	0.0%	0	0.0%	0	0.0%	2	0.6%	2	1.0%	1	0.5%	5	1.2%	9	3.2%	3	4.1%	22	1.0%
男女合計	0	0.0%	3	1.2%	0	0.0%	0	0.0%	6	0.9%	4	1.0%	2	0.5%	10	1.2%	15	3.2%	4	3.4%	44	1.0%
全体(人)																						
男性	82		123		192		238		312		196		211		432		187		43		2016	
女性	74		125		183		264		346		208		221		425		277		73		2196	
男女合計	156		248		375		502		658		404		432		857		464		116		4212	

県 北

	10	割合	20	割合	30	割合	40	割合	50	割合	64	割合	69	割合	70～	割合	全体数	割合
1と回答																		
男性	12	50.0%	32	68.1%	21	47.7%	38	66.7%	58	66.7%	33	67.3%	35	67.3%	88	62.4%	317	63.3%
女性	11	73.3%	34	75.6%	34	75.6%	45	65.2%	73	68.9%	33	75.0%	45	81.8%	114	60.3%	389	68.5%
男女合計	23	59.0%	66	71.7%	55	61.8%	83	65.9%	131	67.9%	66	71.0%	80	74.8%	202	61.2%	706	66.0%
2と回答																		
男性	12	50.0%	15	31.9%	23	52.3%	19	33.3%	27	31.0%	16	32.7%	17	32.7%	50	35.5%	179	35.7%
女性	4	26.7%	11	24.4%	11	24.4%	24	34.8%	31	29.2%	11	25.0%	10	18.2%	74	39.2%	176	31.0%
男女合計	16	41.0%	26	28.3%	34	38.2%	43	34.1%	58	30.1%	27	29.0%	27	25.2%	124	37.6%	355	33.2%
無回答																		
男性	0	0.0%	0	0.0%	0	0.0%	0	0.0%	2	2.3%	0	0.0%	0	0.0%	3	2.1%	5	1.0%
女性	0	0.0%	0	0.0%	0	0.0%	0	0.0%	2	1.9%	0	0.0%	0	0.0%	1	0.5%	3	0.5%
男女合計	0	0.0%	0	0.0%	0	0.0%	0	0.0%	4	2.1%	0	0.0%	0	0.0%	4	1.2%	8	0.7%
全体(人)																		
男性	24		47		44		57		87		49		52		141		501	
女性	15		45		45		69		106		44		55		189		568	
男女合計	39		92		89		126		193		93		107		330		1069	

県 中

	10	割合	20	割合	30	割合	40	割合	50	割合	64	割合	69	割合	70～	割合	全体数	割合
1と回答																		
男性	11	52.4%	17	53.1%	40	78.4%	43	65.2%	60	68.2%	38	80.9%	34	77.3%	86	60.1%	329	66.9%
女性	8	40.0%	27	73.0%	45	83.3%	44	60.3%	55	69.6%	30	60.0%	33	75.0%	95	60.1%	337	65.4%
男女合計	19	46.3%	44	63.8%	85	81.0%	87	62.6%	115	68.9%	68	70.1%	67	76.1%	181	60.1%	666	66.1%
2と回答																		
男性	10	47.6%	13	40.6%	11	21.6%	23	34.8%	28	31.8%	9	19.1%	9	20.5%	55	38.5%	158	32.1%
女性	12	60.0%	10	27.0%	9	16.7%	29	39.7%	24	30.4%	20	40.0%	11	25.0%	57	36.1%	172	33.4%
男女合計	22	53.7%	23	33.3%	20	19.0%	52	37.4%	52	31.1%	29	29.9%	20	22.7%	112	37.2%	330	32.8%
無回答																		
男性	0	0.0%	2	6.3%	0	0.0%	0	0.0%	0	0.0%	0	0.0%	1	2.3%	2	1.4%	5	1.0%
女性	0	0.0%	0	0.0%	0	0.0%	0	0.0%	0	0.0%	0	0.0%	0	0.0%	6	3.8%	6	1.2%
男女合計	0	0.0%	2	2.9%	0	0.0%	0	0.0%	0	0.0%	0	0.0%	1	1.1%	8	2.7%	11	1.1%
全体(人)																		
男性	21		32		51		66		88		47		44		143		492	
女性	20		37		54		73		79		50		44		158		515	
男女合計	41		69		105		139		167		97		88		301		1007	

県 南

	10	割合	20	割合	30	割合	40	割合	50	割合	64	割合	69	割合	70～	割合	全体数	割合
1と回答																		
男性	6	50.0%	7	100.0%	11	55.0%	14	66.7%	22	64.7%	15	71.4%	10	47.6%	45	57.0%	130	60.5%
女性	8	80.0%	5	45.5%	13	86.7%	24	85.7%	29	82.9%	19	73.1%	19	79.2%	61	62.9%	178	72.4%
男女合計	14	63.6%	12	66.7%	24	68.6%	38	77.6%	51	73.9%	34	72.3%	29	64.4%	106	60.2%	308	66.8%
2と回答																		
男性	6	50.0%	0	0.0%	9	45.0%	7	33.3%	12	35.3%	5	23.8%	11	52.4%	32	40.5%	82	38.1%
女性	2	20.0%	6	54.5%	2	13.3%	4	14.3%	6	17.1%	6	23.1%	5	20.8%	33	34.0%	64	26.0%
男女合計	8	36.4%	6	33.3%	11	31.4%	11	22.4%	18	26.1%	11	23.4%	16	35.6%	65	36.9%	146	31.7%
無回答																		
男性	0	0.0%	0	0.0%	0	0.0%	0	0.0%	0	0.0%	1	4.8%	0	0.0%	2	2.5%	3	1.4%
女性	0	0.0%	0	0.0%	0	0.0%	0	0.0%	0	0.0%	1	3.8%	0	0.0%	3	3.1%	4	1.6%
男女合計	0	0.0%	0	0.0%	0	0.0%	0	0.0%	0	0.0%	2	4.3%	0	0.0%	5	2.8%	7	1.5%
全体(人)																		
男性	12		7		20		21		34		21		21		79		215	
女性	10		11		15		28		35		26		24		97		246	
男女合計	22		18		35		49		69		47		45		176		461	

会 津

	10	割合	20	割合	30	割合	40	割合	50	割合	64	割合	69	割合	70～	割合	全体数	割合
1と回答																		
男性	2	33.3%	12	66.7%	21	75.0%	26	60.5%	17	53.1%	13	59.1%	21	84.0%	66	66.7%	178	65.2%
女性	2	28.6%	8	72.7%	17	68.0%	22	57.9%	28	66.7%	25	89.3%	25	78.1%	72	61.5%	199	66.3%
男女合計	4	30.8%	20	69.0%	38	71.7%	48	59.3%	45	60.8%	38	76.0%	46	80.7%	138	63.9%	377	65.8%
2と回答																		
男性	4	66.7%	6	33.3%	7	25.0%	17	39.5%	14	43.8%	9	40.9%	4	16.0%	33	33.3%	94	34.4%
女性	5	71.4%	3	27.3%	8	32.0%	16	42.1%	14	33.3%	3	10.7%	7	21.9%	43	36.8%	99	33.0%
男女合計	9	69.2%	9	31.0%	15	28.3%	33	40.7%	28	37.8%	12	24.0%	11	19.3%	76	35.2%	193	33.7%
無回答																		
男性	0	0.0%	0	0.0%	0	0.0%	0	0.0%	1	3.1%	0	0.0%	0	0.0%	0	0.0%	1	0.4%
女性	0	0.0%	0	0.0%	0	0.0%	0	0.0%	0	0.0%	0	0.0%	0	0.0%	2	1.7%	2	0.7%
男女合計	0	0.0%	0	0.0%	0	0.0%	0	0.0%	1	1.4%	0	0.0%	0	0.0%	2	0.9%	3	0.5%
全体(人)																		
男性	6		18		28		43		32		22		25		99		273	
女性	7		11		25		38		42		28		32		117		300	
男女合計	13		29		53		81		74		50		57		216		573	

南会津

	10	割合	20	割合	30	割合	40	割合	50	割合	64	割合	69	割合	70～	割合	全体数	割合
1と回答																		
男性	0	0.0%	2	66.7%	2	100.0%	1	33.3%	3	100.0%	1	100.0%	2	50.0%	8	57.1%	19	63.3%
女性	0	0.0%	0	0.0%	1	50.0%	3	100.0%	1	100.0%	3	100.0%	1	25.0%	9	69.2%	18	69.2%
男女合計	0	0.0%	2	66.7%	3	75.0%	4	66.7%	4	100.0%	4	100.0%	3	37.5%	17	63.0%	37	66.1%
2と回答																		
男性	0	0.0%	1	33.3%	0	0.0%	2	66.7%	0	0.0%	0	0.0%	2	50.0%	6	42.9%	11	36.7%
女性	0	0.0%	0	0.0%	1	50.0%	0	0.0%	0	0.0%	0	0.0%	3	75.0%	4	30.8%	8	30.8%
男女合計	0	0.0%	1	33.3%	1	25.0%	2	33.3%	0	0.0%	0	0.0%	5	62.5%	10	37.0%	19	33.9%
無回答																		
男性	0	0.0%	0	0.0%	0	0.0%	0	0.0%	0	0.0%	0	0.0%	0	0.0%	0	0.0%	0	0.0%
女性	0	0.0%	0	0.0%	0	0.0%	0	0.0%	0	0.0%	0	0.0%	0	0.0%	0	0.0%	0	0.0%
男女合計	0	0.0%	0	0.0%	0	0.0%	0	0.0%	0	0.0%	0	0.0%	0	0.0%	0	0.0%	0	0.0%
全体(人)																		
男性	0		3		2		3		3		1		4		14		30	
女性	0		0		2		3		1		3		4		13		26	
男女合計	0		3		4		6		4		4		8		27		56	

相 双

	10	割合	20	割合	30	割合	40	割合	50	割合	64	割合	69	割合	70～	割合	全体数	割合
1と回答																		
男性	3	50.0%	4	66.7%	10	83.3%	12	66.7%	15	75.0%	7	50.0%	16	80.0%	39	68.4%	106	69.3%
女性	4	66.7%	3	75.0%	11	78.6%	20	83.3%	16	80.0%	9	81.8%	17	89.5%	39	65.0%	119	75.3%
男女合計	7	58.3%	7	70.0%	21	80.8%	32	76.2%	31	77.5%	16	64.0%	33	84.6%	78	66.7%	225	72.3%
2と回答																		
男性	3	50.0%	1	16.7%	2	16.7%	6	33.3%	5	25.0%	6	42.9%	4	20.0%	18	31.6%	45	29.4%
女性	2	33.3%	1	25.0%	3	21.4%	4	16.7%	4	20.0%	2	18.2%	2	10.5%	19	31.7%	37	23.4%
男女合計	5	41.7%	2	20.0%	5	19.2%	10	23.8%	9	22.5%	8	32.0%	6	15.4%	37	31.6%	82	26.4%
無回答																		
男性	0	0.0%	1	16.7%	0	0.0%	0	0.0%	0	0.0%	1	7.1%	0	0.0%	0	0.0%	2	1.3%
女性	0	0.0%	0	0.0%	0	0.0%	0	0.0%	0	0.0%	0	0.0%	0	0.0%	2	3.3%	2	1.3%
男女合計	0	0.0%	1	10.0%	0	0.0%	0	0.0%	0	0.0%	1	4.0%	0	0.0%	2	1.7%	4	1.3%
全体(人)																		
男性	6		6		12		18		20		14		20		57		153	
女性	6		4		14		24		20		11		19		60		158	
男女合計	12		10		26		42		40		25		39		117		311	

いわき

	10	割合	20	割合	30	割合	40	割合	50	割合	64	割合	69	割合	70～	割合	全体数	割合
1と回答																		
男性	11	84.6%	4	40.0%	22	62.9%	24	80.0%	32	66.7%	31	73.8%	32	71.1%	82	63.6%	238	67.6%
女性	9	56.3%	10	58.8%	22	78.6%	24	82.8%	51	81.0%	29	63.0%	30	69.8%	97	68.8%	272	71.0%
男女合計	20	69.0%	14	51.9%	44	69.8%	48	81.4%	83	74.8%	60	68.2%	62	70.5%	179	66.3%	510	69.4%
2と回答																		
男性	2	15.4%	6	60.0%	13	37.1%	6	20.0%	15	31.3%	11	26.2%	13	28.9%	42	32.6%	108	30.7%
女性	7	43.8%	7	41.2%	6	21.4%	5	17.2%	12	19.0%	16	34.8%	12	27.9%	41	29.1%	106	27.7%
男女合計	9	31.0%	13	48.1%	19	30.2%	11	18.6%	27	24.3%	27	30.7%	25	28.4%	83	30.7%	214	29.1%
無回答																		
男性	0	0.0%	0	0.0%	0	0.0%	0	0.0%	1	2.1%	0	0.0%	0	0.0%	5	3.9%	6	1.7%
女性	0	0.0%	0	0.0%	0	0.0%	0	0.0%	0	0.0%	1	2.2%	1	2.3%	3	2.1%	5	1.3%
男女合計	0	0.0%	0	0.0%	0	0.0%	0	0.0%	1	0.9%	1	1.1%	1	1.1%	8	3.0%	11	1.5%
全体(人)																		
男性	13		10		35		30		48		42		45		129		352	
女性	16		17		28		29		63		46		43		141		383	
男女合計	29		27		63		59		111		88		88		270		735	

全県(60歳以上・再掲)

	64	割合	69	割合	70	割合	80	割合	90	割合	全体数	割合
1と回答												
男性	138	70.4%	150	71.1%	295	68.3%	107	57.2%	12	27.9%	702	65.7%
女性	148	71.2%	170	76.9%	317	74.6%	157	56.7%	13	17.8%	805	66.9%
男女合計	286	70.8%	320	74.1%	612	71.4%	264	56.9%	25	21.6%	1507	66.3%
2と回答												
男性	56	28.6%	60	28.4%	132	30.6%	74	39.6%	30	69.8%	352	32.9%
女性	58	27.9%	50	22.6%	103	24.2%	111	40.1%	57	78.1%	379	31.5%
男女合計	114	28.2%	110	25.5%	235	27.4%	185	39.9%	87	75.0%	731	32.2%
無回答												
男性	2	1.0%	1	0.5%	5	1.2%	6	3.2%	1	2.3%	15	1.4%
女性	2	1.0%	1	0.5%	5	1.2%	9	3.2%	3	4.1%	20	1.7%
男女合計	4	1.0%	2	0.5%	10	1.2%	15	3.2%	4	3.4%	35	1.5%
全体(人)												
男性	196		211		432		187		43		1069	
女性	208		221		425		277		73		1204	
男女合計	404		432		857		464		116		2273	

19 地域活動の実施状況（調査票 問19）

問19 あなたは、何らかの地域活動を実施していますか。（あてはまる番号すべてに○）

- 1 老人クラブ
- 2 健康・スポーツの集まりや団体
- 3 趣味の集まりや団体
- 4 社会奉仕団体（ボランティア団体）
- 5 町内会、自治会の活動
- 6 宗教団体
- 7 職場のクラブ活動など
- 8 その他
- 9 何も参加していない

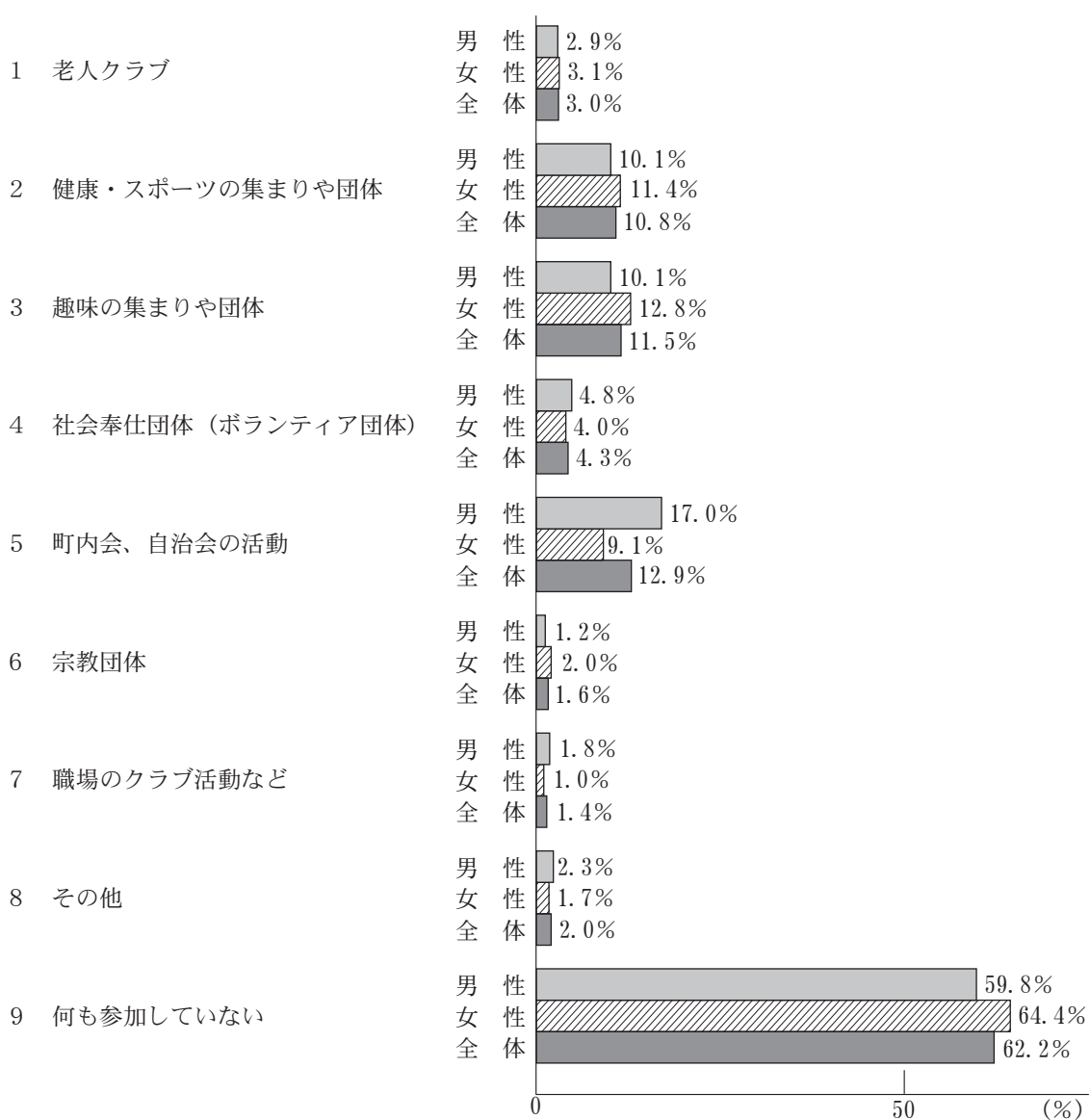

1. 老人クラブと回答した人

	10	割合	20	割合	30	割合	40	割合	50	割合	64	割合	69	割合	70	割合	80	割合	90	割合	全体数	割合
1に○																						
男性	0	0.0%	0	0.0%	0	0.0%	0	0.0%	1	0.3%	0	0.0%	4	1.9%	23	5.3%	24	12.8%	6	14.0%	58	2.9%
女性	0	0.0%	0	0.0%	0	0.0%	1	0.4%	0	0.0%	1	0.5%	3	1.4%	27	6.4%	32	11.6%	5	6.8%	69	3.1%
男女合計	0	0.0%	0	0.0%	0	0.0%	1	0.2%	1	0.2%	1	0.2%	7	1.6%	50	5.8%	56	12.1%	11	9.5%	127	3.0%
全体(人)																						
男性	82		123		192		238		312		196		211		432		187		43		2016	
女性	74		125		183		264		346		208		221		425		277		73		2196	
男女合計	156		248		375		502		658		404		432		857		464		116		4212	

2. 健康・スポーツの集まりや団体と回答した人

	10	割合	20	割合	30	割合	40	割合	50	割合	64	割合	69	割合	70	割合	80	割合	90	割合	全体数	割合
2に○																						
男性	9	11.0%	16	13.0%	14	7.3%	21	8.8%	15	4.8%	14	7.1%	23	10.9%	68	15.7%	19	10.2%	5	11.6%	204	10.1%
女性	3	4.1%	7	5.6%	8	4.4%	11	4.2%	30	8.7%	23	11.1%	42	19.0%	80	18.8%	42	15.2%	5	6.8%	251	11.4%
男女合計	12	7.7%	23	9.3%	22	5.9%	32	6.4%	45	6.8%	37	9.2%	65	15.0%	148	17.3%	61	13.1%	10	8.6%	455	10.8%
全体(人)																						
男性	82		123		192		238		312		196		211		432		187		43		2016	
女性	74		125		183		264		346		208		221		425		277		73		2196	
男女合計	156		248		375		502		658		404		432		857		464		116		4212	

3. 趣味の集まりや団体と回答した人

	10	割合	20	割合	30	割合	40	割合	50	割合	64	割合	69	割合	70	割合	80	割合	90	割合	全体数	割合
3に○																						
男性	7	8.5%	10	8.1%	11	5.7%	17	7.1%	27	8.7%	8	4.1%	31	14.7%	70	16.2%	22	11.8%	1	2.3%	204	10.1%
女性	4	5.4%	7	5.6%	8	4.4%	16	6.1%	31	9.0%	25	12.0%	45	20.4%	99	23.3%	46	16.6%	0	0.0%	281	12.8%
男女合計	11	7.1%	17	6.9%	19	5.1%	33	6.6%	58	8.8%	33	8.2%	76	17.6%	169	19.7%	68	14.7%	1	0.9%	485	11.5%
全体(人)																						
男性	82		123		192		238		312		196		211		432		187		43		2016	
女性	74		125		183		264		346		208		221		425		277		73		2196	
男女合計	156		248		375		502		658		404		432		857		464		116		4212	

4. 社会奉仕団体（ボランティア団体）と回答した人

	10	割合	20	割合	30	割合	40	割合	50	割合	64	割合	69	割合	70	割合	80	割合	90	割合	全体数	割合
4に○																						
男性	0	0.0%	2	1.6%	6	3.1%	8	3.4%	14	4.5%	7	3.6%	11	5.2%	38	8.8%	9	4.8%	1	2.3%	96	4.8%
女性	0	0.0%	4	3.2%	5	2.7%	4	1.5%	8	2.3%	11	5.3%	12	5.4%	32	7.5%	10	3.6%	1	1.4%	87	4.0%
男女合計	0	0.0%	6	2.4%	11	2.9%	12	2.4%	22	3.3%	18	4.5%	23	5.3%	70	8.2%	19	4.1%	2	1.7%	183	4.3%
全体(人)																						
男性	82		123		192		238		312		196		211		432		187		43		2016	
女性	74		125		183		264		346		208		221		425		277		73		2196	
男女合計	156		248		375		502		658		404		432		857		464		116		4212	

5. 町内会、自治会の活動と回答した人

	10	割合	20	割合	30	割合	40	割合	50	割合	64	割合	69	割合	70	割合	80	割合	90	割合	全体数	割合
5に○																						
男性	0	0.0%	7	5.7%	13	6.8%	39	16.4%	60	19.2%	41	20.9%	59	28.0%	94	21.8%	28	15.0%	2	4.7%	343	17.0%
女性	0	0.0%	1	0.8%	14	7.7%	24	9.1%	47	13.6%	23	11.1%	22	10.0%	48	11.3%	19	6.9%	1	1.4%	199	9.1%
男女合計	0	0.0%	8	3.2%	27	7.2%	63	12.5%	107	16.3%	64	15.8%	81	18.8%	142	16.6%	47	10.1%	3	2.6%	542	12.9%
全体(人)																						
男性	82		123		192		238		312		196		211		432		187		43		2016	
女性	74		125		183		264		346		208		221		425		277		73		2196	
男女合計	156		248		375		502		658		404		432		857		464		116		4212	

6. 宗教団体と回答した人

	10	割合	20	割合	30	割合	40	割合	50	割合	64	割合	69	割合	70	割合	80	割合	90	割合	全体数	割合
6に○																						
男性	0	0.0%	0	0.0%	3	1.6%	2	0.8%	2	0.6%	3	1.5%	5	2.4%	9	2.1%	1	0.5%	0	0.0%	25	1.2%
女性	0	0.0%	1	0.8%	2	1.1%	2	0.8%	4	1.2%	7	3.4%	7	3.2%	13	3.1%	8	2.9%	0	0.0%	44	2.0%
男女合計	0	0.0%	1	0.4%	5	1.3%	4	0.8%	6	0.9%	10	2.5%	12	2.8%	22	2.6%	9	1.9%	0	0.0%	69	1.6%
全体(人)																						
男性	82		123		192		238		312		196		211		432		187		43		2016	
女性	74		125		183		264		346		208		221		425		277		73		2196	
男女合計	156		248		375		502		658		404		432		857		464		116		4212	

7. 職場のクラブ活動などと回答した人

	10	割合	20	割合	30	割合	40	割合	50	割合	64	割合	69	割合	70	割合	80	割合	90	割合	全体数	割合
7に○																						
男性	2	2.4%	5	4.1%	7	3.6%	4	1.7%	10	3.2%	0	0.0%	3	1.4%	3	0.7%	3	1.6%	0	0.0%	37	1.8%
女性	4	5.4%	4	3.2%	3	1.6%	7	2.7%	2	0.6%	1	0.5%	0	0.0%	1	0.2%	0	0.0%	0	0.0%	22	1.0%
男女合計	6	3.8%	9	3.6%	10	2.7%	11	2.2%	12	1.8%	1	0.2%	3	0.7%	4	0.5%	3	0.6%	0	0.0%	59	1.4%
全体(人)																						
男性	82		123		192		238		312		196		211		432		187		43		2016	
女性	74		125		183		264		346		208		221		425		277		73		2196	
男女合計	156		248		375		502		658		404		432		857		464		116		4212	

8. その他と回答した人

	10	割合	20	割合	30	割合	40	割合	50	割合	64	割合	69	割合	70	割合	80	割合	90	割合	全体数	割合
8に○																						
男性	1	1.2%	1	0.8%	7	3.6%	4	1.7%	3	1.0%	4	2.0%	5	2.4%	16	3.7%	5	2.7%	1	2.3%	47	2.3%
女性	2	2.7%	1	0.8%	3	1.6%	1	0.4%	3	0.9%	8	3.8%	4	1.8%	13	3.1%	1	0.4%	1	1.4%	37	1.7%
男女合計	3	1.9%	2	0.8%	10	2.7%	5	1.0%	6	0.9%	12	3.0%	9	2.1%	29	3.4%	6	1.3%	2	1.7%	84	2.0%
全体(人)																						
男性	82		123		192		238		312		196		211		432		187		43		2016	
女性	74		125		183		264		346		208		221		425		277		73		2196	
男女合計	156		248		375		502		658		404		432		857		464		116		4212	

9. 何も参加していないと回答した人

	10	割合	20	割合	30	割合	40	割合	50	割合	64	割合	69	割合	70	割合	80	割合	90	割合	全体数	割合
9に○																						
男性	60	73.2%	88	71.5%	140	72.9%	151	63.4%	208	66.7%	127	64.8%	103	48.8%	203	47.0%	96	51.3%	29	67.4%	1205	59.8%
女性	59	79.7%	101	80.8%	143	78.1%	205	77.7%	243	70.2%	134	64.4%	123	55.7%	197	46.4%	155	56.0%	55	75.3%	1415	64.4%
男女合計	119	76.3%	189	76.2%	283	75.5%	356	70.9%	451	68.5%	261	64.6%	226	52.3%	400	46.7%	251	54.1%	84	72.4%	2620	62.2%
全体(人)																						
男性	82		123		192		238		312		196		211		432		187		43		2016	
女性	74		125		183		264		346		208		221		425		277		73		2196	
男女合計	156		248		375		502		658		404		432		857		464		116		4212	

20 睡眠時間の状況（調査票 問20）

問20 あなたのふだんの睡眠時間は、どのくらいですか。（あてはまる番号1つに○）

1 4時間以下	2 5時間位	3 6時間位
4 7時間位	5 8時間位	6 9時間以上

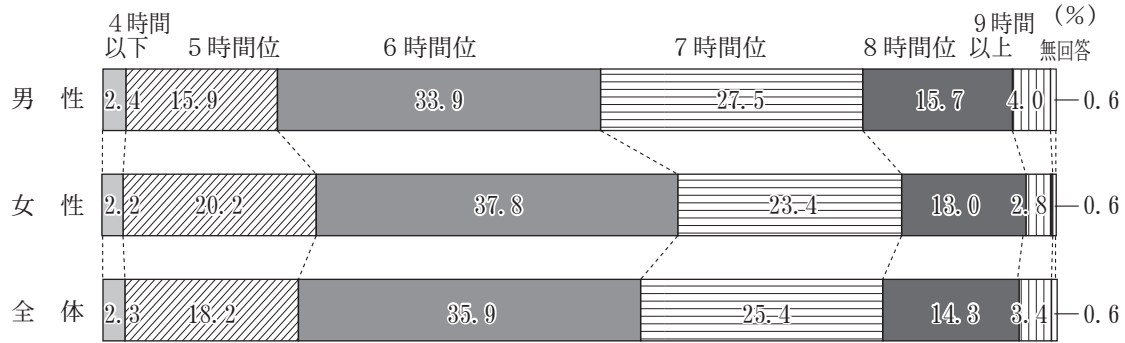

	10	割合	20	割合	30	割合	40	割合	50	割合	64	割合	69	割合	70	割合	80	割合	90	割合	全体数	割合
1と回答																						
男性	3	3.7%	4	3.3%	5	2.6%	7	2.9%	6	1.9%	4	2.0%	4	1.9%	8	1.9%	6	3.2%	1	2.3%	48	2.4%
女性	2	2.7%	2	1.6%	3	1.6%	7	2.7%	9	2.6%	5	2.4%	10	4.5%	9	2.1%	1	0.4%	1	1.4%	49	2.2%
男女合計	5	3.2%	6	2.4%	8	2.1%	14	2.8%	15	2.3%	9	2.2%	14	3.2%	17	2.0%	7	1.5%	2	1.7%	97	2.3%
2と回答																						
男性	8	9.8%	23	18.7%	37	19.3%	47	19.7%	74	23.7%	37	18.9%	20	9.5%	55	12.7%	18	9.6%	2	4.7%	321	15.9%
女性	12	16.2%	24	19.2%	40	21.9%	55	20.8%	98	28.3%	54	26.0%	46	20.8%	83	19.5%	29	10.5%	3	4.1%	444	20.2%
男女合計	20	12.8%	47	19.0%	77	20.5%	102	20.3%	172	26.1%	91	22.5%	66	15.3%	138	16.1%	47	10.1%	5	4.3%	765	18.2%
3と回答																						
男性	33	40.2%	53	43.1%	81	42.2%	103	43.3%	107	34.3%	82	41.8%	75	35.5%	112	25.9%	30	16.0%	7	16.3%	683	33.9%
女性	37	50.0%	52	41.6%	72	39.3%	120	45.5%	149	43.1%	97	46.6%	70	31.7%	148	34.8%	71	25.6%	14	19.2%	830	37.8%
男女合計	70	44.9%	105	42.3%	153	40.8%	223	44.4%	256	38.9%	179	44.3%	145	33.6%	260	30.3%	101	21.8%	21	18.1%	1513	35.9%
4と回答																						
男性	27	32.9%	26	21.1%	47	24.5%	57	23.9%	92	29.5%	56	28.6%	76	36.0%	127	29.4%	37	19.8%	10	23.3%	555	27.5%
女性	16	21.6%	29	23.2%	50	27.3%	55	20.8%	66	19.1%	37	17.8%	65	29.4%	115	27.1%	71	25.6%	10	13.7%	514	23.4%
男女合計	43	27.6%	55	22.2%	97	25.9%	112	22.3%	158	24.0%	93	23.0%	141	32.6%	242	28.2%	108	23.3%	20	17.2%	1069	25.4%
5と回答																						
男性	8	9.8%	14	11.4%	21	10.9%	23	9.7%	28	9.0%	15	7.7%	30	14.2%	103	23.8%	66	35.3%	8	18.6%	316	15.7%
女性	5	6.8%	15	12.0%	15	8.2%	25	9.5%	19	5.5%	13	6.3%	29	13.1%	63	14.8%	79	28.5%	22	30.1%	285	13.0%
男女合計	13	8.3%	29	11.7%	36	9.6%	48	9.6%	47	7.1%	28	6.9%	59	13.7%	166	19.4%	145	31.3%	30	25.9%	601	14.3%
6と回答																						
男性	2	2.4%	2	1.6%	1	0.5%	1	0.4%	4	1.3%	1	0.5%	5	2.4%	24	5.6%	26	13.9%	15	34.9%	81	4.0%
女性	1	1.4%	2	1.6%	3	1.6%	2	0.8%	5	1.4%	1	0.5%	1	0.5%	3	0.7%	23	8.3%	20	27.4%	61	2.8%
男女合計	3	1.9%	4	1.6%	4	1.1%	3	0.6%	9	1.4%	2	0.5%	6	1.4%	27	3.2%	49	10.6%	35	30.2%	142	3.4%
無回答																						
男性	1	1.2%	1	0.8%	0	0.0%	0	0.0%	1	0.3%	1	0.5%	1	0.5%	3	0.7%	4	2.1%	0	0.0%	12	0.6%
女性	1	1.4%	1	0.8%	0	0.0%	0	0.0%	0	0.0%	1	0.5%	0	0.0%	4	0.9%	3	1.1%	3	4.1%	13	0.6%
男女合計	2	1.3%	2	0.8%	0	0.0%	0	0.0%	1	0.2%	2	0.5%	1	0.2%	7	0.8%	7	1.5%	3	2.6%	25	0.6%
全体(人)																						
男性	82	123	192	238	312	196	211	432	187	43	2016											
女性	74	125	183	264	346	208	221	425	277	73	2196											
男女合計	156	248	375	502	658	404	432	857	464	116	4212											

県 北

	10	割合	20	割合	30	割合	40	割合	50	割合	64	割合	69	割合	70～	割合	全体数	割合
1と回答																		
男性	0	0.0%	2	4.3%	0	0.0%	2	3.5%	0	0.0%	0	0.0%	0	0.0%	2	1.4%	6	1.2%
女性	1	6.7%	0	0.0%	0	0.0%	3	4.3%	3	2.8%	0	0.0%	0	0.0%	1	0.5%	8	1.4%
男女合計	1	2.6%	2	2.2%	0	0.0%	5	4.0%	3	1.6%	0	0.0%	0	0.0%	3	0.9%	14	1.3%
2と回答																		
男性	3	12.5%	7	14.9%	7	15.9%	12	21.1%	20	23.0%	10	20.4%	7	13.5%	22	15.6%	88	17.6%
女性	5	33.3%	8	17.8%	8	17.8%	13	18.8%	30	28.3%	10	22.7%	7	12.7%	26	13.8%	107	18.8%
男女合計	8	20.5%	15	16.3%	15	16.9%	25	19.8%	50	25.9%	20	21.5%	14	13.1%	48	14.5%	195	18.2%
3と回答																		
男性	11	45.8%	18	38.3%	21	47.7%	22	38.6%	29	33.3%	17	34.7%	16	30.8%	32	22.7%	166	33.1%
女性	4	26.7%	21	46.7%	19	42.2%	31	44.9%	42	39.6%	19	43.2%	23	41.8%	66	34.9%	225	39.6%
男女合計	15	38.5%	39	42.4%	40	44.9%	53	42.1%	71	36.8%	36	38.7%	39	36.4%	98	29.7%	391	36.6%
4と回答																		
男性	6	25.0%	13	27.7%	11	25.0%	9	15.8%	26	29.9%	18	36.7%	21	40.4%	36	25.5%	140	27.9%
女性	3	20.0%	10	22.2%	14	31.1%	16	23.2%	24	22.6%	12	27.3%	21	38.2%	37	19.6%	137	24.1%
男女合計	9	23.1%	23	25.0%	25	28.1%	25	19.8%	50	25.9%	30	32.3%	42	39.3%	73	22.1%	277	25.9%
5と回答																		
男性	3	12.5%	7	14.9%	4	9.1%	12	21.1%	10	11.5%	4	8.2%	8	15.4%	39	27.7%	87	17.4%
女性	1	6.7%	5	11.1%	4	8.9%	5	7.2%	5	4.7%	3	6.8%	4	7.3%	43	22.8%	70	12.3%
男女合計	4	10.3%	12	13.0%	8	9.0%	17	13.5%	15	7.8%	7	7.5%	12	11.2%	82	24.8%	157	14.7%
6と回答																		
男性	1	4.2%	0	0.0%	1	2.3%	0	0.0%	1	1.1%	0	0.0%	0	0.0%	9	6.4%	12	2.4%
女性	1	6.7%	1	2.2%	0	0.0%	1	1.4%	2	1.9%	0	0.0%	0	0.0%	14	7.4%	19	3.3%
男女合計	2	5.1%	1	1.1%	1	1.1%	1	0.8%	3	1.6%	0	0.0%	0	0.0%	23	7.0%	31	2.9%
無回答																		
男性	0	0.0%	0	0.0%	0	0.0%	0	0.0%	1	1.1%	0	0.0%	0	0.0%	1	0.7%	2	0.4%
女性	0	0.0%	0	0.0%	0	0.0%	0	0.0%	0	0.0%	0	0.0%	0	0.0%	2	1.1%	2	0.4%
男女合計	0	0.0%	0	0.0%	0	0.0%	0	0.0%	1	0.5%	0	0.0%	0	0.0%	3	0.9%	4	0.4%
全体(人)																		
男性	24		47		44		57		87		49		52		141		501	
女性	15		45		45		69		106		44		55		189		568	
男女合計	39		92		89		126		193		93		107		330		1069	

県 中

	10	割合	20	割合	30	割合	40	割合	50	割合	64	割合	69	割合	70～	割合	全体数	割合
1と回答																		
男性	2	9.5%	0	0.0%	1	2.0%	3	4.5%	2	2.3%	1	2.1%	0	0.0%	2	1.4%	11	2.2%
女性	1	5.0%	1	2.7%	1	1.9%	3	4.1%	2	2.5%	4	8.0%	0	0.0%	3	1.9%	15	2.9%
男女合計	3	7.3%	1	1.4%	2	1.9%	6	4.3%	4	2.4%	5	5.2%	0	0.0%	5	1.7%	26	2.6%
2と回答																		
男性	2	9.5%	8	25.0%	10	19.6%	16	24.2%	24	27.3%	4	8.5%	5	11.4%	10	7.0%	79	16.1%
女性	4	20.0%	9	24.3%	15	27.8%	18	24.7%	24	30.4%	10	20.0%	11	25.0%	19	12.0%	110	21.4%
男女合計	6	14.6%	17	24.6%	25	23.8%	34	24.5%	48	28.7%	14	14.4%	16	18.2%	29	9.6%	189	18.8%
3と回答																		
男性	7	33.3%	13	40.6%	19	37.3%	25	37.9%	36	40.9%	20	42.6%	18	40.9%	32	22.4%	170	34.6%
女性	10	50.0%	9	24.3%	17	31.5%	29	39.7%	32	40.5%	25	50.0%	12	27.3%	46	29.1%	180	35.0%
男女合計	17	41.5%	22	31.9%	36	34.3%	54	38.8%	68	40.7%	45	46.4%	30	34.1%	78	25.9%	350	34.8%
4と回答																		
男性	9	42.9%	7	21.9%	12	23.5%	16	24.2%	17	19.3%	15	31.9%	15	34.1%	43	30.1%	134	27.2%
女性	4	20.0%	11	29.7%	13	24.1%	19	26.0%	15	19.0%	6	12.0%	15	34.1%	41	25.9%	124	24.1%
男女合計	13	31.7%	18	26.1%	25	23.8%	35	25.2%	32	19.2%	21	21.6%	30	34.1%	84	27.9%	258	25.6%
5と回答																		
男性	1	4.8%	2	6.3%	9	17.6%	6	9.1%	8	9.1%	7	14.9%	4	9.1%	44	30.8%	81	16.5%
女性	1	5.0%	5	13.5%	5	9.3%	4	5.5%	5	6.3%	5	10.0%	6	13.6%	40	25.3%	71	13.8%
男女合計	2	4.9%	7	10.1%	14	13.3%	10	7.2%	13	7.8%	12	12.4%	10	11.4%	84	27.9%	152	15.1%
6と回答																		
男性	0	0.0%	1	3.1%	0	0.0%	0	0.0%	1	1.1%	0	0.0%	2	4.5%	11	7.7%	15	3.0%
女性	0	0.0%	1	2.7%	3	5.6%	0	0.0%	1	1.3%	0	0.0%	0	0.0%	7	4.4%	12	2.3%
男女合計	0	0.0%	2	2.9%	3	2.9%	0	0.0%	2	1.2%	0	0.0%	2	2.3%	18	6.0%	27	2.7%
無回答																		
男性	0	0.0%	1	3.1%	0	0.0%	0	0.0%	0	0.0%	0	0.0%	0	0.0%	1	0.7%	2	0.4%
女性	0	0.0%	1	2.7%	0	0.0%	0	0.0%	0	0.0%	0	0.0%	0	0.0%	2	1.3%	3	0.6%
男女合計	0	0.0%	2	2.9%	0	0.0%	0	0.0%	0	0.0%	0	0.0%	0	0.0%	3	1.0%	5	0.5%
全体(人)																		
男性	21		32		51		66		88		47		44		143		492	
女性	20		37		54		73		79		50		44		158		515	
男女合計	41		69		105		139		167		97		88		301		1007	

県 南

	10	割合	20	割合	30	割合	40	割合	50	割合	64	割合	69	割合	70～	割合	全体数	割合
1と回答																		
男性	1	8.3%	0	0.0%	0	0.0%	0	0.0%	3	8.8%	1	4.8%	3	14.3%	2	2.5%	10	4.7%
女性	0	0.0%	0	0.0%	0	0.0%	1	3.6%	0	0.0%	1	3.8%	2	8.3%	1	1.0%	5	2.0%
男女合計	1	4.5%	0	0.0%	0	0.0%	1	2.0%	3	4.3%	2	4.3%	5	11.1%	3	1.7%	15	3.3%
2と回答																		
男性	0	0.0%	3	42.9%	1	5.0%	2	9.5%	7	20.6%	7	33.3%	0	0.0%	6	7.6%	26	12.1%
女性	1	10.0%	2	18.2%	3	20.0%	9	32.1%	12	34.3%	5	19.2%	6	25.0%	16	16.5%	54	22.0%
男女合計	1	4.5%	5	27.8%	4	11.4%	11	22.4%	19	27.5%	12	25.5%	6	13.3%	22	12.5%	80	17.4%
3と回答																		
男性	4	33.3%	3	42.9%	8	40.0%	15	71.4%	12	35.3%	6	28.6%	6	28.6%	16	20.3%	70	32.6%
女性	6	60.0%	6	54.5%	6	40.0%	9	32.1%	14	40.0%	17	65.4%	5	20.8%	28	28.9%	91	37.0%
男女合計	10	45.5%	9	50.0%	14	40.0%	24	49.0%	26	37.7%	23	48.9%	11	24.4%	44	25.0%	161	34.9%
4と回答																		
男性	5	41.7%	1	14.3%	8	40.0%	3	14.3%	10	29.4%	6	28.6%	6	28.6%	19	24.1%	58	27.0%
女性	2	20.0%	2</															

会 津

	10	割合	20	割合	30	割合	40	割合	50	割合	64	割合	69	割合	70～	割合	全体数	割合
1と回答																		
男性	0	0.0%	1	5.6%	1	3.6%	2	4.7%	1	3.1%	0	0.0%	0	0.0%	3	3.0%	8	2.9%
女性	0	0.0%	0	0.0%	1	4.0%	0	0.0%	2	4.8%	0	0.0%	3	9.4%	0	0.0%	6	2.0%
男女合計	0	0.0%	1	3.4%	2	3.8%	2	2.5%	3	4.1%	0	0.0%	3	5.3%	3	1.4%	14	2.4%
2と回答																		
男性	0	0.0%	2	11.1%	6	21.4%	7	16.3%	7	21.9%	4	18.2%	3	12.0%	12	12.1%	41	15.0%
女性	0	0.0%	2	18.2%	4	16.0%	6	15.8%	7	16.7%	5	17.9%	9	28.1%	24	20.5%	57	19.0%
男女合計	0	0.0%	4	13.8%	10	18.9%	13	16.0%	14	18.9%	9	18.0%	12	21.1%	36	16.7%	98	17.1%
3と回答																		
男性	4	66.7%	9	50.0%	13	46.4%	18	41.9%	10	31.3%	12	54.5%	7	28.0%	18	18.2%	91	33.3%
女性	4	57.1%	9	81.8%	10	40.0%	20	52.6%	24	57.1%	13	46.4%	6	18.8%	31	26.5%	117	39.0%
男女合計	8	61.5%	18	62.1%	23	43.4%	38	46.9%	34	45.9%	25	50.0%	13	22.8%	49	22.7%	208	36.3%
4と回答																		
男性	1	16.7%	3	16.7%	6	21.4%	15	34.9%	12	37.5%	5	22.7%	11	44.0%	24	24.2%	77	28.2%
女性	1	14.3%	0	0.0%	7	28.0%	8	21.1%	8	19.0%	8	28.6%	7	21.9%	31	26.5%	70	23.3%
男女合計	2	15.4%	3	10.3%	13	24.5%	23	28.4%	20	27.0%	13	26.0%	18	31.6%	55	25.5%	147	25.7%
5と回答																		
男性	1	16.7%	2	11.1%	2	7.1%	1	2.3%	1	3.1%	0	0.0%	3	12.0%	31	31.3%	41	15.0%
女性	2	28.6%	0	0.0%	3	12.0%	4	10.5%	1	2.4%	2	7.1%	7	21.9%	24	20.5%	43	14.3%
男女合計	3	23.1%	2	6.9%	5	9.4%	5	6.2%	2	2.7%	2	4.0%	10	17.5%	55	25.5%	84	14.7%
6と回答																		
男性	0	0.0%	1	5.6%	0	0.0%	0	0.0%	1	3.1%	1	4.5%	1	4.0%	11	11.1%	15	5.5%
女性	0	0.0%	0	0.0%	0	0.0%	0	0.0%	0	0.0%	0	0.0%	0	0.0%	5	4.3%	5	1.7%
男女合計	0	0.0%	1	3.4%	0	0.0%	0	0.0%	1	1.4%	1	2.0%	1	1.8%	16	7.4%	20	3.5%
無回答																		
男性	0	0.0%	0	0.0%	0	0.0%	0	0.0%	0	0.0%	0	0.0%	0	0.0%	0	0.0%	0	0.0%
女性	0	0.0%	0	0.0%	0	0.0%	0	0.0%	0	0.0%	0	0.0%	0	0.0%	2	1.7%	2	0.7%
男女合計	0	0.0%	0	0.0%	0	0.0%	0	0.0%	0	0.0%	0	0.0%	0	0.0%	2	0.9%	2	0.3%
全体(人)																		
男性	6		18		28		43		32		22		25		99		273	
女性	7		11		25		38		42		28		32		117		300	
男女合計	13		29		53		81		74		50		57		216		573	

南 会 津

	10	割合	20	割合	30	割合	40	割合	50	割合	64	割合	69	割合	70～	割合	全体数	割合
1と回答																		
男性	0	0.0%	0	0.0%	0	0.0%	0	0.0%	0	0.0%	0	0.0%	0	0.0%	0	0.0%	0	0.0%
女性	0	0.0%	0	0.0%	0	0.0%	0	0.0%	0	0.0%	0	0.0%	1	25.0%	0	0.0%	1	3.8%
男女合計	0	0.0%	0	0.0%	0	0.0%	0	0.0%	0	0.0%	0	0.0%	1	12.5%	0	0.0%	1	1.8%
2と回答																		
男性	0	0.0%	0	0.0%	1	50.0%	0	0.0%	0	0.0%	1	100.0%	1	25.0%	3	21.4%	6	20.0%
女性	0	0.0%	0	0.0%	0	0.0%	1	33.3%	0	0.0%	1	33.3%	1	25.0%	4	30.8%	7	26.9%
男女合計	0	0.0%	0	0.0%	1	25.0%	1	16.7%	0	0.0%	2	50.0%	2	25.0%	7	25.9%	13	23.2%
3と回答																		
男性	0	0.0%	2	66.7%	0	0.0%	1	33.3%	0	0.0%	0	0.0%	1	25.0%	2	14.3%	6	20.0%
女性	0	0.0%	2	100.0%	2	100.0%	1	33.3%	0	0.0%	1	33.3%	1	25.0%	1	7.7%	6	23.1%
男女合計	0	0.0%	2	66.7%	2	50.0%	2	33.3%	0	0.0%	1	25.0%	2	25.0%	3	11.1%	12	21.4%
4と回答																		
男性	0	0.0%	0	0.0%	1	50.0%	2	66.7%	3	100.0%	0	0.0%	2	50.0%	4	28.6%	12	40.0%
女性	0	0.0%	0	0.0%	0	0.0%	1	33.3%	0	0.0%	1	33.3%	1	25.0%	4	30.8%	7	26.9%
男女合計	0	0.0%	0	0.0%	1	25.0%	3	50.0%	3	75.0%	1	25.0%	3	37.5%	8	29.6%	19	33.9%
5と回答																		
男性	0	0.0%	1	33.3%	0	0.0%	0	0.0%	0	0.0%	0	0.0%	0	0.0%	3	21.4%	4	13.3%
女性	0	0.0%	0	0.0%	0	0.0%	0	0.0%	1	100.0%	0	0.0%	0	0.0%	3	23.1%	4	15.4%
男女合計	0	0.0%	1	33.3%	0	0.0%	0	0.0%	1	25.0%	0	0.0%	0	0.0%	6	22.2%	8	14.3%
6と回答																		
男性	0	0.0%	0	0.0%	0	0.0%	0	0.0%	0	0.0%	0	0.0%	0	0.0%	2	14.3%	2	6.7%
女性	0	0.0%	0	0.0%	0	0.0%	0	0.0%	0	0.0%	0	0.0%	0	0.0%	0	0.0%	0	0.0%
男女合計	0	0.0%	0	0.0%	0	0.0%	0	0.0%	0	0.0%	0	0.0%	0	0.0%	2	7.4%	2	3.6%
無回答																		
男性	0	0.0%	0	0.0%	0	0.0%	0	0.0%	0	0.0%	0	0.0%	0	0.0%	0	0.0%	0	0.0%
女性	0	0.0%	0	0.0%	0	0.0%	0	0.0%	0	0.0%	0	0.0%	0	0.0%	1	7.7%	1	3.8%
男女合計	0	0.0%	0	0.0%	0	0.0%	0	0.0%	0	0.0%	0	0.0%	0	0.0%	1	3.7%	1	1.8%
全体(人)																		
男性	0		3		2		3		3		1		4		14		30	
女性	0		0		2		3		1		3		4		13		26	
男女合計	0		3		4		6		4		4		8		27		56	

相 双

	10	割合	20	割合	30	割合	40	割合	50	割合	64	割合	69	割合	70～	割合	全体数	割合
1と回答																		
男性	0	0.0%	0	0.0%	2	16.7%	0	0.0%	0	0.0%	2	14.3%	0	0.0%	3	5.3%	7	4.6%
女性	0	0.0%	1	25.0%	0	0.0%	0	0.0%	0	0.0%	0	0.0%	2	10.5%	1	1.7%	4	2.5%
男女合計	0	0.0%	1	10.0%	2	7.7%	0	0.0%	0	0.0%	2	8.0%	2	5.1%	4	3.4%	11	3.5%
2と回答																		
男性	0	0.0%	2	33.3%	2	16.7%	7	38.9%	4	20.0%	2	14.3%	1	5.0%	10	17.5%	28	18.3%
女性	0	0.0%	1	25.0%	4	28.6%	3	12.5%	4	20.0%	8	72.7%	3	15.8%	7	11.7%	30	19.0%
男女合計	0	0.0%	3	30.0%	6	23.1%	10	23.8%	8	20.0%	10	40.0%	4	10.3%	17	14.5%	58	18.6%
3と回答																		
男性	4	66.7%	1	16.7%	5	41.7%	5	27.8%	5	25.0%	5	35.7%	9	45.0%	10	17.5%	44	28.8%
女性	3	50.0%	1	25.0%	7	50.0%	12	50.0%	9	45.0%	2	18.2%	7	36.8%	25	41.7%	66	41.8%
男女合計	7	58.3%	2	20.0%	12	46.2%	17	40.5%	14	35.0%	7	28.0%	16	41.0%	35	29.9%	110	35.4%
4と回答																		
男性	1	16.7%	1	16.7%	1	8.3%	6	33.3%	8	40.0%	3	21.4%	7	35.0%	15	26.3%	42	27.5%
女性	2	33.3%	0	0.0%	3	21.4%	3	12.5%	3	15.0%	1	9.1%	5	26.3%	7	11.7%	24	15.2%
男女合計	3	25.0%	1	10.0%	4	15.4%												

いわき

	10	割合	20	割合	30	割合	40	割合	50	割合	64	割合	69	割合	70～	割合	全体数	割合
1と回答																		
男性	0	0.0%	1	10.0%	1	2.9%	0	0.0%	0	0.0%	0	0.0%	1	2.2%	3	2.3%	6	1.7%
女性	0	0.0%	0	0.0%	1	3.6%	0	0.0%	2	3.2%	0	0.0%	2	4.7%	5	3.5%	10	2.6%
男女合計	0	0.0%	1	3.7%	2	3.2%	0	0.0%	2	1.8%	0	0.0%	3	3.4%	8	3.0%	16	2.2%
2と回答																		
男性	3	23.1%	1	10.0%	10	28.6%	3	10.0%	12	25.0%	9	21.4%	3	6.7%	12	9.3%	53	15.1%
女性	2	12.5%	2	11.8%	6	21.4%	5	17.2%	21	33.3%	15	32.6%	9	20.9%	19	13.5%	79	20.6%
男女合計	5	17.2%	3	11.1%	16	25.4%	8	13.6%	33	29.7%	24	27.3%	12	13.6%	31	11.5%	132	18.0%
3と回答																		
男性	3	23.1%	7	70.0%	15	42.9%	17	56.7%	15	31.3%	22	52.4%	18	40.0%	39	30.2%	136	38.6%
女性	10	62.5%	6	35.3%	11	39.3%	18	62.1%	28	44.4%	20	43.5%	16	37.2%	36	25.5%	145	37.9%
男女合計	13	44.8%	13	48.1%	26	41.3%	35	59.3%	43	38.7%	42	47.7%	34	38.6%	75	27.8%	281	38.2%
4と回答																		
男性	5	38.5%	1	10.0%	8	22.9%	6	20.0%	16	33.3%	9	21.4%	14	31.1%	33	25.6%	92	26.1%
女性	4	25.0%	6	35.3%	8	28.6%	4	13.8%	9	14.3%	6	13.0%	9	20.9%	52	36.9%	98	25.6%
男女合計	9	31.0%	7	25.9%	16	25.4%	10	16.9%	25	22.5%	15	17.0%	23	26.1%	85	31.5%	190	25.9%
5と回答																		
男性	1	7.7%	0	0.0%	1	2.9%	3	10.0%	5	10.4%	2	4.8%	6	13.3%	27	20.9%	45	12.8%
女性	0	0.0%	3	17.6%	2	7.1%	1	3.4%	2	3.2%	3	6.5%	7	16.3%	22	15.6%	40	10.4%
男女合計	1	3.4%	3	11.1%	3	4.8%	4	6.8%	7	6.3%	5	5.7%	13	14.8%	49	18.1%	85	11.6%
6と回答																		
男性	1	7.7%	0	0.0%	0	0.0%	1	3.3%	0	0.0%	0	0.0%	2	4.4%	13	10.1%	17	4.8%
女性	0	0.0%	0	0.0%	0	0.0%	1	3.4%	1	1.6%	1	2.2%	0	0.0%	7	5.0%	10	2.6%
男女合計	1	3.4%	0	0.0%	0	0.0%	2	3.4%	1	0.9%	1	1.1%	2	2.3%	20	7.4%	27	3.7%
無回答																		
男性	0	0.0%	0	0.0%	0	0.0%	0	0.0%	0	0.0%	0	0.0%	1	2.2%	2	1.6%	3	0.9%
女性	0	0.0%	0	0.0%	0	0.0%	0	0.0%	0	0.0%	1	2.2%	0	0.0%	0	0.0%	1	0.3%
男女合計	0	0.0%	0	0.0%	0	0.0%	0	0.0%	0	0.0%	1	1.1%	1	1.1%	2	0.7%	4	0.5%
全体(人)																		
男性	13		10		35		30		48		42		45		129		352	
女性	16		17		28		29		63		46		43		141		383	
男女合計	29		27		63		59		111		88		88		270		735	

全県 (60歳以上・再掲)

	64	割合	69	割合	70	割合	80	割合	90	割合	全体数	割合
1と回答												
男性	4	2.0%	4	1.9%	8	1.9%	6	3.2%	1	2.3%	23	2.2%
女性	5	2.4%	10	4.5%	9	2.1%	1	0.4%	1	1.4%	26	2.2%
男女合計	9	2.2%	14	3.2%	17	2.0%	7	1.5%	2	1.7%	49	2.2%
2と回答												
男性	37	18.9%	20	9.5%	55	12.7%	18	9.6%	2	4.7%	132	12.3%
女性	54	26.0%	46	20.8%	83	19.5%	29	10.5%	3	4.1%	215	17.9%
男女合計	91	22.5%	66	15.3%	138	16.1%	47	10.1%	5	4.3%	347	15.3%
3と回答												
男性	82	41.8%	75	35.5%	112	25.9%	30	16.0%	7	16.3%	306	28.6%
女性	97	46.6%	70	31.7%	148	34.8%	71	25.6%	14	19.2%	400	33.2%
男女合計	179	44.3%	145	33.6%	260	30.3%	101	21.8%	21	18.1%	706	31.1%
4と回答												
男性	56	28.6%	76	36.0%	127	29.4%	37	19.8%	10	23.3%	306	28.6%
女性	37	17.8%	65	29.4%	115	27.1%	71	25.6%	10	13.7%	298	24.8%
男女合計	93	23.0%	141	32.6%	242	28.2%	108	23.3%	20	17.2%	604	26.6%
5と回答												
男性	15	7.7%	30	14.2%	103	23.8%	66	35.3%	8	18.6%	222	20.8%
女性	13	6.3%	29	13.1%	63	14.8%	79	28.5%	22	30.1%	206	17.1%
男女合計	28	6.9%	59	13.7%	166	19.4%	145	31.3%	30	25.9%	428	18.8%
6と回答												
男性	1	0.5%	5	2.4%	24	5.6%	26	13.9%	15	34.9%	71	6.6%
女性	1	0.5%	1	0.5%	3	0.7%	23	8.3%	20	27.4%	48	4.0%
男女合計	2	0.5%	6	1.4%	27	3.2%	49	10.6%	35	30.2%	119	5.2%
無回答												
男性	1	0.5%	1	0.5%	3	0.7%	4	2.1%	0	0.0%	9	0.8%
女性	1	0.5%	0	0.0%	4	0.9%	3	1.1%	3	4.1%	11	0.9%
男女合計	2	0.5%	1	0.2%	7	0.8%	7	1.5%	3	2.6%	20	0.9%
全体(人)												
男性	196		211		432		187		43		1069	
女性	208		221		425		277		73		1204	
男女合計	404		432		857		464		116		2273	

21 睡眠による休養の状況（調査票 問21）

問21 ここ1ヶ月間、あなたは睡眠で休養が十分とれていますか。（あてはまる番号1つに○）

- | | |
|-------------|--------------|
| 1 十分とれている | 2 まあまあとれている |
| 3 あまりとれていない | 4 まったくとれていない |

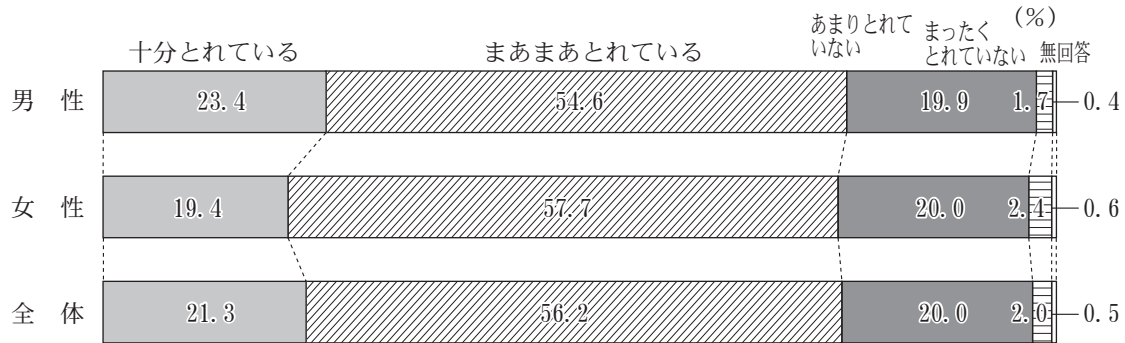

	10	割合	20	割合	30	割合	40	割合	50	割合	64	割合	69	割合	70	割合	80	割合	90	割合	全体数	割合
1と回答																						
男性	16	19.5%	24	19.5%	29	15.1%	39	16.4%	52	16.7%	35	17.9%	51	24.2%	131	30.3%	77	41.2%	17	39.5%	471	23.4%
女性	16	21.6%	15	12.0%	23	12.6%	42	15.9%	38	11.0%	32	15.4%	42	19.0%	102	24.0%	81	29.2%	35	47.9%	426	19.4%
男女合計	32	20.5%	39	15.7%	52	13.9%	81	16.1%	90	13.7%	67	16.6%	93	21.5%	233	27.2%	158	34.1%	52	44.8%	897	21.3%
2と回答																						
男性	45	54.9%	66	53.7%	108	56.3%	141	59.2%	157	50.3%	117	59.7%	117	55.5%	244	56.5%	86	46.0%	19	44.2%	1100	54.6%
女性	48	64.9%	76	60.8%	106	57.9%	143	54.2%	202	58.4%	121	58.2%	141	63.8%	237	55.8%	161	58.1%	31	42.5%	1266	57.7%
男女合計	93	59.6%	142	57.3%	214	57.1%	284	56.6%	359	54.6%	238	58.9%	258	59.7%	481	56.1%	247	53.2%	50	43.1%	2366	56.2%
3と回答																						
男性	19	23.2%	30	24.4%	50	26.0%	51	21.4%	95	30.4%	42	21.4%	40	19.0%	51	11.8%	17	9.1%	7	16.3%	402	19.9%
女性	8	10.8%	32	25.6%	46	25.1%	66	25.0%	95	27.5%	47	22.6%	34	15.4%	77	18.1%	30	10.8%	4	5.5%	439	20.0%
男女合計	27	17.3%	62	25.0%	96	25.6%	117	23.3%	190	28.9%	89	22.0%	74	17.1%	128	14.9%	47	10.1%	11	9.5%	841	20.0%
4と回答																						
男性	1	1.2%	2	1.6%	5	2.6%	7	2.9%	7	2.2%	1	0.5%	3	1.4%	5	1.2%	3	1.6%	0	0.0%	34	1.7%
女性	1	1.4%	2	1.6%	8	4.4%	13	4.9%	11	3.2%	7	3.4%	4	1.8%	3	0.7%	3	1.1%	0	0.0%	52	2.4%
男女合計	2	1.3%	4	1.6%	13	3.5%	20	4.0%	18	2.7%	8	2.0%	7	1.6%	8	0.9%	6	1.3%	0	0.0%	86	2.0%
無回答																						
男性	1	1.2%	1	0.8%	0	0.0%	0	0.0%	1	0.3%	1	0.5%	0	0.0%	1	0.2%	4	2.1%	0	0.0%	9	0.4%
女性	1	1.4%	0	0.0%	0	0.0%	0	0.0%	0	0.0%	1	0.5%	0	0.0%	6	1.4%	2	0.7%	3	4.1%	13	0.6%
男女合計	2	1.3%	1	0.4%	0	0.0%	0	0.0%	1	0.2%	2	0.5%	0	0.0%	7	0.8%	6	1.3%	3	2.6%	22	0.5%
全体(人)																						
男性	82		123		192		238		312		196		211		432		187		43		2016	
女性	74		125		183		264		346		208		221		425		277		73		2196	
男女合計	156		248		375		502		658		404		432		857		464		116		4212	

県 北

	10	割合	20	割合	30	割合	40	割合	50	割合	64	割合	69	割合	70～	割合	全体数	割合
1と回答																		
男性	6	25.0%	11	23.4%	7	15.9%	11	19.3%	18	20.7%	7	14.3%	12	23.1%	48	34.0%	120	24.0%
女性	1	6.7%	4	8.9%	5	11.1%	15	21.7%	11	10.4%	4	9.1%	11	20.0%	57	30.2%	108	19.0%
男女合計	7	17.9%	15	16.3%	12	13.5%	26	20.6%	29	15.0%	11	11.8%	23	21.5%	105	31.8%	228	21.3%
2と回答																		
男性	12	50.0%	25	53.2%	26	59.1%	32	56.1%	41	47.1%	32	65.3%	30	57.7%	72	51.1%	270	53.9%
女性	12	80.0%	28	62.2%	21	46.7%	32	46.4%	60	56.6%	28	63.6%	35	63.6%	97	51.3%	313	55.1%
男女合計	24	61.5%	53	57.6%	47	52.8%	64	50.8%	101	52.3%	60	64.5%	65	60.7%	169	51.2%	583	54.5%
3と回答																		
男性	6	25.0%	10	21.3%	10	22.7%	13	22.8%	25	28.7%	10	20.4%	9	17.3%	20	14.2%	103	20.6%
女性	2	13.3%	13	28.9%	16	35.6%	16	23.2%	33	31.1%	10	22.7%	9	16.4%	27	14.3%	126	22.2%
男女合計	8	20.5%	23	25.0%	26	29.2%	29	23.0%	58	30.1%	20	21.5%	18	16.8%	47	14.2%	229	21.4%
4と回答																		
男性	0	0.0%	1	2.1%	1	2.3%	1	1.8%	2	2.3%	0	0.0%	1	1.9%	1	0.7%	7	1.4%
女性	0	0.0%	0	0.0%	3	6.7%	6	8.7%	2	1.9%	2	4.5%	0	0.0%	3	1.6%	16	2.8%
男女合計	0	0.0%	1	1.1%	4	4.5%	7	5.6%	4	2.1%	2	2.2%	1	0.9%	4	1.2%	23	2.2%
無回答																		
男性	0	0.0%	0	0.0%	0	0.0%	0	0.0%	1	1.1%	0	0.0%	0	0.0%	0	0.0%	1	0.2%
女性	0	0.0%	0	0.0%	0	0.0%	0	0.0%	0	0.0%	0	0.0%	0	0.0%	5	2.6%	5	0.9%
男女合計	0	0.0%	0	0.0%	0	0.0%	0	0.0%	1	0.5%	0	0.0%	0	0.0%	5	1.5%	6	0.6%
全体(人)																		
男性	24		47		44		57		87		49		52		141		501	
女性	15		45		45		69		106		44		55		189		568	
男女合計	39		92		89		126		193		93		107		330		1069	

県 中

	10	割合	20	割合	30	割合	40	割合	50	割合	64	割合	69	割合	70～	割合	全体数	割合
1と回答																		
男性	3	14.3%	6	18.8%	9	17.6%	13	19.7%	13	14.8%	11	23.4%	11	25.0%	46	32.2%	112	22.8%
女性	3	15.0%	7	18.9%	9	16.7%	11	15.1%	7	8.9%	10	20.0%	8	18.2%	38	24.1%	93	18.1%
男女合計	6	14.6%	13	18.8%	18	17.1%	24	17.3%	20	12.0%	21	21.6%	19	21.6%	84	27.9%	205	20.4%
2と回答																		
男性	14	66.7%	18	56.3%	28	54.9%	37	56.1%	40	45.5%	26	55.3%	25	56.8%	81	56.6%	269	54.7%
女性	14	70.0%	18	48.6%	33	61.1%	37	50.7%	44	55.7%	28	56.0%	31	70.5%	99	62.7%	304	59.0%
男女合計	28	68.3%	36	52.2%	61	58.1%	74	53.2%	84	50.3%	54	55.7%	56	63.6%	180	59.8%	573	56.9%
3と回答																		
男性	4	19.0%	6	18.8%	13	25.5%	15	22.7%	33	37.5%	9	19.1%	8	18.2%	13	9.1%	101	20.5%
女性	2	10.0%	12	32.4%	11	20.4%	22	30.1%	26	32.9%	10	20.0%	4	9.1%	20	12.7%	107	20.8%
男女合計	6	14.6%	18	26.1%	24	22.9%	37	26.6%	59	35.3%	19	19.6%	12	13.6%	33	11.0%	208	20.7%
4と回答																		
男性	0	0.0%	1	3.1%	1	2.0%	1	1.5%	2	2.3%	1	2.1%	0	0.0%	3	2.1%	9	1.8%
女性	1	5.0%	0	0.0%	1	1.9%	3	4.1%	2	2.5%	2	4.0%	1	2.3%	0	0.0%	10	1.9%
男女合計	1	2.4%	1	1.4%	2	1.9%	4	2.9%	4	2.4%	3	3.1%	1	1.1%	3	1.0%	19	1.9%
無回答																		
男性	0	0.0%	1	3.1%	0	0.0%	0	0.0%	0	0.0%	0	0.0%	0	0.0%	0	0.0%	1	0.2%
女性	0	0.0%	0	0.0%	0	0.0%	0	0.0%	0	0.0%	0	0.0%	0	0.0%	1	0.6%	1	0.2%
男女合計	0	0.0%	1	1.4%	0	0.0%	0	0.0%	0	0.0%	0	0.0%	0	0.0%	1	0.3%	2	0.2%
全体(人)																		
男性	21		32		51		66		88		47		44		143		492	
女性	20		37		54		73		79		50		44		158		515	
男女合計	41		69		105		139		167		97		88		301		1007	

県 南

	10	割合	20	割合	30	割合	40	割合	50	割合	64	割合	69	割合	70～	割合	全体数	割合
1と回答																		
男性	4	33.3%	0	0.0%	3	15.0%	3	14.3%	7	20.6%	3	14.3%	8	38.1%	38	48.1%	66	30.7%
女性	2	20.0%	0	0.0%	0	0.0%	6	21.4%	5	14.3%	3	11.5%	2	8.3%	28	28.9%	46	18.7%
男女合計	6	27.3%	0	0.0%	3	8.6%	9	18.4%	12	17.4%	6	12.8%	10	22.2%	66	37.5%	112	24.3%
2と回答																		
男性	4	33.3%	3	42.9%	9	45.0%	13	61.9%	14	41.2%	11	52.4%	5	23.8%	28	35.4%	87	40.5%
女性	7	70.0%	8	72.7%	11	73.3%	13	46.4%	18	51.4%	18	69.2%	14	58.3%	49	50.5%	138	56.1%
男女合計	11	50.0%	11	61.1%	20	57.1%	26	53.1%	32	46.4%	29	61.7%	19	42.2%	77	43.8%	225	48.8%
3と回答																		
男性	3	25.0%	4	57.1%	7	35.0%	5	23.8%	13	38.2%	6	28.6%	7	33.3%	10	12.7%	55	25.6%
女性	1	10.0%	2	18.2%	4	26.7%	7	25.0%	10	28.6%	4	15.4%	8	33.3%	18	18.6%	54	22.0%
男女合計	4	18.2%	6	33.3%	11	31.4%	12	24.5%	23	33.3%	10	21.3%	15	33.3%	28	15.9%	109	23.6%
4と回答																		
男性	1	8.3%	0	0.0%	1	5.0%	0	0.0%	0	0.0%	0	0.0%	1	4.8%	2	2.5%	5	2.3%
女性	0	0.0%	1	9.1%	0	0.0%	2	7.1%	2	5.7%	1	3.8%	0	0.0%	0	0.0%	6	2.4%
男女合計	1	4.5%	1	5.6%	1	2.9%	2	4.1%	2	2.9%	1	2.1%	1	2.2%	2	1.1%	11	2.4%
無回答																		
男性	0	0.0%	0	0.0%	0	0.0%	0	0.0%	0	0.0%	1	4.8%	0	0.0%	1	1.3%	2	0.9%
女性	0	0.0%	0	0.0%	0	0.0%	0	0.0%	0	0.0%	0	0.0%	0	0.0%	2	2.1%	2	0.8%
男女合計	0	0.0%	0	0.0%	0	0.0%	0	0.0%	0	0.0%	1	2.1%	0	0.0%	3	1.7%	4	0.9%
全体(人)																		
男性	12		7		20		21		34		21		21		79		215	
女性	10		11		15		28		35		26		24		97		246	
男女合計	22		18		35		49		69		47		45		176		461	

会 津

	10	割合	20	割合	30	割合	40	割合	50	割合	64	割合	69	割合	70～	割合	全体数	割合
1と回答																		
男性	1	16.7%	3	16.7%	3	10.7%	4	9.3%	3	9.4%	3	13.6%	6	24.0%	30	30.3%	53	19.4%
女性	3	42.9%	2	18.2%	3	12.0%	5	13.2%	5	11.9%	8	28.6%	6	18.8%	36	30.8%	68	22.7%
男女合計	4	30.8%	5	17.2%	6	11.3%	9	11.1%	8	10.8%	11	22.0%	12	21.1%	66	30.6%	121	21.1%
2と回答																		
男性	3	50.0%	10	55.6%	21	75.0%	28	65.1%	18	56.3%	14	63.6%	13	52.0%	55	55.6%	162	59.3%
女性	3	42.9%	7	63.6%	14	56.0%	24	63.2%	26	61.9%	14	50.0%	22	68.8%	66	56.4%	176	58.7%
男女合計	6	46.2%	17	58.6%	35	66.0%	52	64.2%	44	59.5%	28	56.0%	35	61.4%	121	56.0%	338	59.0%
3と回答																		
男性	2	33.3%	5	27.8%	4	14.3%	9	20.9%	9	28.1%	5	22.7%	5	20.0%	12	12.1%	51	18.7%
女性	1	14.3%	2	18.2%	5	20.0%	8	21.1%	9	21.4%	6	21.4%	4	12.5%	14	12.0%	49	16.3%
男女合計	3	23.1%	7	24.1%	9	17.0%	17	21.0%	18	24.3%	11	22.0%	9	15.8%	26	12.0%	100	17.5%
4と回答																		
男性	0	0.0%	0	0.0%	0	0.0%	2	4.7%	2	6.3%	0	0.0%	1	4.0%	1	1.0%	6	2.2%
女性	0	0.0%	0	0.0%	3	12.0%	1	2.6%	2	4.8%	0	0.0%	0	0.0%	0	0.0%	6	2.0%
男女合計	0	0.0%	0	0.0%	3	5.7%	3	3.7%	4	5.4%	0	0.0%	1	1.8%	1	0.5%	12	2.1%
無回答																		
男性	0	0.0%	0	0.0%	0	0.0%	0	0.0%	0	0.0%	0	0.0%	0	0.0%	1	1.0%	1	0.4%
女性	0	0.0%	0	0.0%	0	0.0%	0	0.0%	0	0.0%	0	0.0%	0	0.0%	1	0.9%	1	0.3%
男女合計	0	0.0%	0	0.0%	0	0.0%	0	0.0%	0	0.0%	0	0.0%	0	0.0%	2	0.9%	2	0.3%
全体(人)																		
男性	6		18		28		43		32		22		25		99		273	
女性	7		11		25		38		42		28		32		117		300	
男女合計	13		29		53		81		74		50		57		216		573	

南 会 津

	10	割合	20	割合	30	割合	40	割合	50	割合	64	割合	69	割合	70～	割合	全体数	割合
1と回答																		
男性	0	0.0%	1	33.3%	0	0.0%	0	0.0%	0	0.0%	0	0.0%	3	75.0%	6	42.9%	10	33.3%
女性	0	0.0%	0	0.0%	0	0.0%	0	0.0%	0	0.0%	1	33.3%	2	50.0%	0	0.0%	3	11.5%
男女合計	0	0.0%	1	33.3%	0	0.0%	0	0.0%	0	0.0%	1	25.0%	5	62.5%	6	22.2%	13	23.2%
2と回答																		
男性	0	0.0%	1	33.3%	0	0.0%	3	100.0%	2	66.7%	1	100.0%	1	25.0%	7	50.0%	15	50.0%
女性	0	0.0%	0	0.0%	1	50.0%	1	33.3%	1	100.0%	2	66.7%	1	25.0%	11	84.6%	17	65.4%
男女合計	0	0.0%	1	33.3%	1	25.0%	4	66.7%	3	75.0%	3	75.0%	2	25.0%	18	66.7%	32	57.1%
3と回答																		
男性	0	0.0%	1	33.3%	1	50.0%	0	0.0%	1	33.3%	0	0.0%	0	0.0%	1	7.1%	4	13.3%
女性	0	0.0%	0	0.0%	1	50.0%	2	66.7%	0	0.0%	0	0.0%	1	25.0%	2	15.4%	6	23.1%
男女合計	0	0.0%	1	33.3%	2	50.0%	2	33.3%	1	25.0%	0	0.0%	1	12.5%	3	11.1%	10	17.9%
4と回答																		
男性	0	0.0%	0	0.0%	1	50.0%	0	0.0%	0	0.0%	0	0.0%	0	0.0%	0	0.0%	1	3.3%
女性	0	0.0%	0	0.0%	0	0.0%	0	0.0%	0	0.0%	0	0.0%	0	0.0%	0	0.0%	0	0.0%
男女合計	0	0.0%	0	0.0%	1	25.0%	0	0.0%	0	0.0%	0	0.0%	0	0.0%	0	0.0%	1	1.8%
無回答																		
男性	0	0.0%	0	0.0%	0	0.0%	0	0.0%	0	0.0%	0	0.0%	0	0.0%	0	0.0%	0	0.0%
女性	0	0.0%	0	0.0%	0	0.0%	0	0.0%	0	0.0%	0	0.0%	0	0.0%	0	0.0%	0	0.0%
男女合計	0	0.0%	0	0.0%	0	0.0%	0	0.0%	0	0.0%	0	0.0%	0	0.0%	0	0.0%	0	0.0%
全体(人)																		
男性	0		3		2		3		3		1		4		14		30	
女性	0		0		2		3		1		3		4		13		26	
男女合計	0		3		4		6		4		4		8		27		56	

相 双

	10	割合	20	割合	30	割合	40	割合	50	割合	64	割合	69	割合	70～	割合	全体数	割合
1と回答																		
男性	0	0.0%	1	16.7%	3	25.0%	1	5.6%	4	20.0%	2	14.3%	4	20.0%	13	22.8%	28	18.3%
女性	2	33.3%	0	0.0%	1	7.1%	1	4.2%	6	30.0%	2	18.2%	4	21.1%	16	26.7%	32	20.3%
男女合計	2	16.7%	1	10.0%	4	15.4%	2	4.8%	10	25.0%	4	16.0%	8	20.5%	29	24.8%	60	19.3%
2と回答																		
男性	4	66.7%	4	66.7%	4	33.3%	11	61.1%	10	50.0%	10	71.4%	13	65.0%	35	61.4%	91	59.5%
女性	3	50.0%	2	50.0%	10	71.4%	19	79.2%	8	40.0%	4	36.4%	10	52.6%	32	53.3%	88	55.7%
男女合計	7	58.3%	6	60.0%	14	53.8%	30	71.4%	18	45.0%	14	56.0%	23	59.0%	67	57.3%	179	57.6%
3と回答																		
男性	1	16.7%	1	16.7%	4	33.3%	4	22.2%	6	30.0%	2	14.3%	3	15.0%	9	15.8%	30	19.6%
女性	0	0.0%	1	25.0%	3	21.4%	3	12.5%	5	25.0%	5	45.5%	4	21.1%	11	18.3%	32	20.3%
男女合計	1	8.3%	2	20.0%	7	26.9%	7	16.7%	11	27.5%	7	28.0%	7	17.9%	20	17.1%	62	19.9%
4と回答																		
男性	0	0.0%	0	0.0%	1	8.3%	2	11.1%	0	0.0%	0	0.0%	0	0.0%	0	0.0%	3	2.0%
女性	0	0.0%	1	25.0%	0	0.0%	1	4.2%	1	5.0%	0	0.0%	1	5.3%	0	0.0%	4	2.5%
男女合計	0	0.0%	1	10.0%	1	3.8%	3	7.1%	1	2.5%	0	0.0%	1	2.6%	0	0.0%	7	2.3%
無回答																		
男性	1	16.7%	0	0.0%	0	0.0%	0	0.0%	0	0.0%	0	0.0%	0	0.0%	0	0.0%	1	0.7%
女性	1	16.7%	0	0.0%	0	0.0%	0	0.0%	0	0.0%	0	0.0%	0	0.0%	1	1.7%	2	1.3%
男女合計	2	16.7%	0	0.0%	0	0.0%	0	0.0%	0	0.0%	0	0.0%	0	0.0%	1	0.9%	3	1.0%
全体(人)																		
男性	6		6		12		18		20		14		20		57		153	
女性	6		4		14		24		20		11		19		60		158	
男女合計	12		10		26		42		40		25		39		117		311	

いわき

	10	割合	20	割合	30	割合	40	割合	50	割合	64	割合	69	割合	70～	割合	全体数	割合
1と回答																		
男性	2	15.4%	2	20.0%	4	11.4%	7	23.3%	7	14.6%	9	21.4%	7	15.6%	44	34.1%	82	23.3%
女性	5	31.3%	2	11.8%	5	17.9%	4	13.8%	4	6.3%	4	8.7%	9	20.9%	43	30.5%	76	19.8%
男女合計	7	24.1%	4	14.8%	9	14.3%	11	18.6%	11	9.9%	13	14.8%	16	18.2%	87	32.2%	158	21.5%
2と回答																		
男性	8	61.5%	5	50.0%	20	57.1%	17	56.7%	32	66.7%	23	54.8%	30	66.7%	71	55.0%	206	58.5%
女性	9	56.3%	13	76.5%	16	57.1%	17	58.6%	45	71.4%	27	58.7%	28	65.1%	75	53.2%	230	60.1%
男女合計	17	58.6%	18	66.7%	36	57.1%	34	57.6%	77	69.4%	50	56.8%	58	65.9%	146	54.1%	436	59.3%
3と回答																		
男性	3	23.1%	3	30.0%	11	31.4%	5	16.7%	8	16.7%	10	23.8%	8	17.8%	10	7.8%	58	16.5%
女性	2	12.5%	2	11.8%	6	21.4%	8	27.6%	12	19.0%	12	26.1%	4	9.3%	19	13.5%	65	17.0%
男女合計	5	17.2%	5	18.5%	17	27.0%	13	22.0%	20	18.0%	22	25.0%	12	13.6%	29	10.7%	123	16.7%
4と回答																		
男性	0	0.0%	0	0.0%	0	0.0%	1	3.3%	1	2.1%	0	0.0%	0	0.0%	1	0.8%	3	0.9%
女性	0	0.0%	0	0.0%	1	3.6%	0	0.0%	2	3.2%	2	4.3%	2	4.7%	3	2.1%	10	2.6%
男女合計	0	0.0%	0	0.0%	1	1.6%	1	1.7%	3	2.7%	2	2.3%	2	2.3%	4	1.5%	13	1.8%
無回答																		
男性	0	0.0%	0	0.0%	0	0.0%	0	0.0%	0	0.0%	0	0.0%	0	0.0%	3	2.3%	3	0.9%
女性	0	0.0%	0	0.0%	0	0.0%	0	0.0%	0	0.0%	1	2.2%	0	0.0%	1	0.7%	2	0.5%
男女合計	0	0.0%	0	0.0%	0	0.0%	0	0.0%	0	0.0%	1	1.1%	0	0.0%	4	1.5%	5	0.7%
全体(人)																		
男性	13		10		35		30		48		42		45		129		352	
女性	16		17		28		29		63		46		43		141		383	
男女合計	29		27		63		59		111		88		88		270		735	

全県(60歳以上・再掲)

	64	割合	69	割合	70	割合	80	割合	90	割合	全体数	割合
1と回答												
男性	35	17.9%	51	24.2%	131	30.3%	77	41.2%	17	39.5%	311	29.1%
女性	32	15.4%	42	19.0%	102	24.0%	81	29.2%	35	47.9%	292	24.3%
男女合計	67	16.6%	93	21.5%	233	27.2%	158	34.1%	52	44.8%	603	26.5%
2と回答												
男性	117	59.7%	117	55.5%	244	56.5%	86	46.0%	19	44.2%	583	54.5%
女性	121	58.2%	141	63.8%	237	55.8%	161	58.1%	31	42.5%	691	57.4%
男女合計	238	58.9%	258	59.7%	481	56.1%	247	53.2%	50	43.1%	1274	56.0%
3と回答												
男性	42	21.4%	40	19.0%	51	11.8%	17	9.1%	7	16.3%	157	14.7%
女性	47	22.6%	34	15.4%	77	18.1%	30	10.8%	4	5.5%	192	15.9%
男女合計	89	22.0%	74	17.1%	128	14.9%	47	10.1%	11	9.5%	349	15.4%
4と回答												
男性	1	0.5%	3	1.4%	5	1.2%	3	1.6%	0	0.0%	12	1.1%
女性	7	3.4%	4	1.8%	3	0.7%	3	1.1%	0	0.0%	17	1.4%
男女合計	8	2.0%	7	1.6%	8	0.9%	6	1.3%	0	0.0%	29	1.3%
無回答												
男性	1	0.5%	0	0.0%	1	0.2%	4	2.1%	0	0.0%	6	0.6%
女性	1	0.5%	0	0.0%	6	1.4%	2	0.7%	3	4.1%	12	1.0%
男女合計	2	0.5%	0	0.0%	7	0.8%	6	1.3%	3	2.6%	18	0.8%
全体(人)												
男性	196		211		432		187		43		1069	
女性	208		221		425		277		73		1204	
男女合計	404		432		857		464		116		2273	

22 疲労の状況（調査票 問22）

問22 あなたは、疲れすぎたと感じていますか。（あてはまる番号1つに○）

1 感じている 2 あまり感じていない 3 まったく感じていない

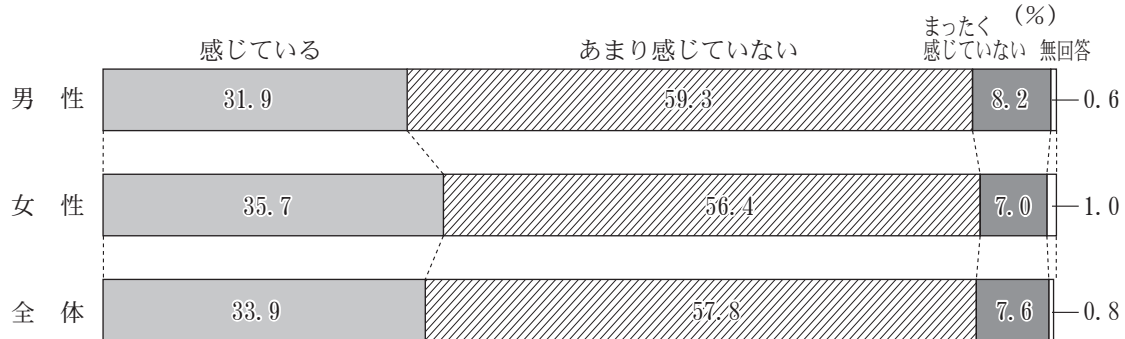

	10	割合	20	割合	30	割合	40	割合	50	割合	64	割合	69	割合	70	割合	80	割合	90	割合	全体数	割合
1と回答																						
男性	17	20.7%	37	30.1%	76	39.6%	100	42.0%	125	40.1%	60	30.6%	64	30.3%	113	26.2%	40	21.4%	12	27.9%	644	31.9%
女性	14	18.9%	41	32.8%	78	42.6%	109	41.3%	152	43.9%	75	36.1%	73	33.0%	130	30.6%	90	32.5%	21	28.8%	783	35.7%
男女合計	31	19.9%	78	31.5%	154	41.1%	209	41.6%	277	42.1%	135	33.4%	137	31.7%	243	28.4%	130	28.0%	33	28.4%	1427	33.9%
2と回答																						
男性	56	68.3%	69	56.1%	104	54.2%	123	51.7%	167	53.5%	121	61.7%	136	64.5%	276	63.9%	119	63.6%	24	55.8%	1195	59.3%
女性	51	68.9%	77	61.6%	95	51.9%	142	53.8%	180	52.0%	121	58.2%	128	57.9%	257	60.5%	152	54.9%	35	47.9%	1238	56.4%
男女合計	107	68.6%	146	58.9%	199	53.1%	265	52.8%	347	52.7%	242	59.9%	264	61.1%	533	62.2%	271	58.4%	59	50.9%	2433	57.8%
3と回答																						
男性	8	9.8%	16	13.0%	12	6.3%	15	6.3%	19	6.1%	14	7.1%	11	5.2%	39	9.0%	24	12.8%	7	16.3%	165	8.2%
女性	8	10.8%	7	5.6%	10	5.5%	13	4.9%	14	4.0%	11	5.3%	19	8.6%	32	7.5%	27	9.7%	13	17.8%	154	7.0%
男女合計	16	10.3%	23	9.3%	22	5.9%	28	5.6%	33	5.0%	25	6.2%	30	6.9%	71	8.3%	51	11.0%	20	17.2%	319	7.6%
無回答																						
男性	1	1.2%	1	0.8%	0	0.0%	0	0.0%	1	0.3%	1	0.5%	0	0.0%	4	0.9%	4	2.1%	0	0.0%	12	0.6%
女性	1	1.4%	0	0.0%	0	0.0%	0	0.0%	0	0.0%	1	0.5%	1	0.5%	6	1.4%	8	2.9%	4	5.5%	21	1.0%
男女合計	2	1.3%	1	0.4%	0	0.0%	0	0.0%	1	0.2%	2	0.5%	1	0.2%	10	1.2%	12	2.6%	4	3.4%	33	0.8%
全体(人)																						
男性	82	123	192	238	312	196	211	432	187	43											2016	
女性	74	125	183	264	346	208	221	425	277	73											2196	
男女合計	156	248	375	502	658	404	432	857	464	116											4212	

県 北

	10	割合	20	割合	30	割合	40	割合	50	割合	64	割合	69	割合	70～	割合	全体数	割合
1と回答																		
男性	4	16.7%	8	17.0%	14	31.8%	24	42.1%	33	37.9%	18	36.7%	12	23.1%	33	23.4%	146	29.1%
女性	2	13.3%	15	33.3%	21	46.7%	26	37.7%	41	38.7%	15	34.1%	21	38.2%	57	30.2%	198	34.9%
男女合計	6	15.4%	23	25.0%	35	39.3%	50	39.7%	74	38.3%	33	35.5%	33	30.8%	90	27.3%	344	32.2%
2と回答																		
男性	17	70.8%	29	61.7%	26	59.1%	29	50.9%	46	52.9%	28	57.1%	38	73.1%	87	61.7%	300	59.9%
女性	11	73.3%	28	62.2%	23	51.1%	39	56.5%	60	56.6%	26	59.1%	27	49.1%	115	60.8%	329	57.9%
男女合計	28	71.8%	57	62.0%	49	55.1%	68	54.0%	106	54.9%	54	58.1%	65	60.7%	202	61.2%	629	58.8%
3と回答																		
男性	3	12.5%	10	21.3%	4	9.1%	4	7.0%	7	8.0%	3	6.1%	2	3.8%	19	13.5%	52	10.4%
女性	2	13.3%	2	4.4%	1	2.2%	4	5.8%	5	4.7%	3	6.8%	6	10.9%	15	7.9%	38	6.7%
男女合計	5	12.8%	12	13.0%	5	5.6%	8	6.3%	12	6.2%	6	6.5%	8	7.5%	34	10.3%	90	8.4%
無回答																		
男性	0	0.0%	0	0.0%	0	0.0%	0	0.0%	1	1.1%	0	0.0%	0	0.0%	2	1.4%	3	0.6%
女性	0	0.0%	0	0.0%	0	0.0%	0	0.0%	0	0.0%	0	0.0%	1	1.8%	2	1.1%	3	0.5%
男女合計	0	0.0%	0	0.0%	0	0.0%	0	0.0%	1	0.5%	0	0.0%	1	0.9%	4	1.2%	6	0.6%
全体(人)																		
男性	24		47		44		57		87		49		52		141		501	
女性	15		45		45		69		106		44		55		189		568	
男女合計	39		92		89		126		193		93		107		330		1069	

県 中

	10	割合	20	割合	30	割合	40	割合	50	割合	64	割合	69	割合	70～	割合	全体数	割合
1と回答																		
男性	3	14.3%	9	28.1%	18	35.3%	27	40.9%	42	47.7%	19	40.4%	15	34.1%	33	23.1%	166	33.7%
女性	6	30.0%	12	32.4%	17	31.5%	34	46.6%	39	49.4%	20	40.0%	12	27.3%	45	28.5%	185	35.9%
男女合計	9	22.0%	21	30.4%	35	33.3%	61	43.9%	81	48.5%	39	40.2%	27	30.7%	78	25.9%	351	34.9%
2と回答																		
男性	17	81.0%	21	65.6%	28	54.9%	33	50.0%	43	48.9%	24	51.1%	29	65.9%	97	67.8%	292	59.3%
女性	12	60.0%	24	64.9%	31	57.4%	37	50.7%	39	49.4%	28	56.0%	31	70.5%	93	58.9%	295	57.3%
男女合計	29	70.7%	45	65.2%	59	56.2%	70	50.4%	82	49.1%	52	53.6%	60	68.2%	190	63.1%	587	58.3%
3と回答																		
男性	1	4.8%	1	3.1%	5	9.8%	6	9.1%	3	3.4%	4	8.5%	0	0.0%	13	9.1%	33	6.7%
女性	2	10.0%	1	2.7%	6	11.1%	2	2.7%	1	1.3%	1	2.0%	1	2.3%	16	10.1%	30	5.8%
男女合計	3	7.3%	2	2.9%	11	10.5%	8	5.8%	4	2.4%	5	5.2%	1	1.1%	29	9.6%	63	6.3%
無回答																		
男性	0	0.0%	1	3.1%	0	0.0%	0	0.0%	0	0.0%	0	0.0%	0	0.0%	0	0.0%	1	0.2%
女性	0	0.0%	0	0.0%	0	0.0%	0	0.0%	0	0.0%	1	2.0%	0	0.0%	4	2.5%	5	1.0%
男女合計	0	0.0%	1	1.4%	0	0.0%	0	0.0%	0	0.0%	1	1.0%	0	0.0%	4	1.3%	6	0.6%
全体(人)																		
男性	21		32		51		66		88		47		44		143		492	
女性	20		37		54		73		79		50		44		158		515	
男女合計	41		69		105		139		167		97		88		301		1007	

県 南

	10	割合	20	割合	30	割合	40	割合	50	割合	64	割合	69	割合	70～	割合	全体数	割合
1と回答																		
男性	4	33.3%	4	57.1%	9	45.0%	10	47.6%	14	41.2%	5	23.8%	7	33.3%	25	31.6%	78	36.3%
女性	0	0.0%	5	45.5%	7	46.7%	11	39.3%	19	54.3%	7	26.9%	11	45.8%	38	39.2%	98	39.8%
男女合計	4	18.2%	9	50.0%	16	45.7%	21	42.9%	33	47.8%	12	25.5%	18	40.0%	63	35.8%	176	38.2%
2と回答																		
男性	5	41.7%	3	42.9%	10	50.0%	11	52.4%	16	47.1%	13	61.9%	12	57.1%	48	60.8%	118	54.9%
女性	9	90.0%	5	45.5%	7	46.7%	14	50.0%	13	37.1%	18	69.2%	11	45.8%	47	48.5%	124	50.4%
男女合計	14	63.6%	8	44.4%	17	48.6%	25	51.0%	29	42.0%	31	66.0%	23	51.1%	95	54.0%	242	52.5%
3と回答																		
男性	3	25.0%	0	0.0%	1	5.0%	0	0.0%	4	11.8%	2	9.5%	2	9.5%	4	5.1%	16	7.4%
女性	1	10.0%	1	9.1%	1	6.7%	3	10.7%	3	8.6%	1	3.8%	2	8.3%	6	6.2%	18	7.3%
男女合計	4	18.2%	1	5.6%	2	5.7%	3	6.1%	7	10.1%	3	6.4%	4	8.9%	10	5.7%	34	7.4%
無回答																		
男性	0	0.0%	0	0.0%	0	0.0%	0	0.0%	0	0.0%	1	4.8%	0	0.0%	2	2.5%	3	1.4%
女性	0	0.0%	0	0.0%	0	0.0%	0	0.0%	0	0.0%	0	0.0%	0	0.0%	6	6.2%	6	2.4%
男女合計	0	0.0%	0	0.0%	0	0.0%	0	0.0%	0	0.0%	1	2.1%	0	0.0%	8	4.5%	9	2.0%
全体(人)																		
男性	12		7		20		21		34		21		21		79		215	
女性	10		11		15		28		35		26		24		97		246	
男女合計	22		18		35		49		69		47		45		176		461	

会 津

	10	割合	20	割合	30	割合	40	割合	50	割合	64	割合	69	割合	70～	割合	全体数	割合
1と回答																		
男性	2	33.3%	6	33.3%	14	50.0%	16	37.2%	13	40.6%	5	22.7%	9	36.0%	23	23.2%	88	32.2%
女性	1	14.3%	4	36.4%	14	56.0%	18	47.4%	18	42.9%	4	14.3%	9	28.1%	30	25.6%	98	32.7%
男女合計	3	23.1%	10	34.5%	28	52.8%	34	42.0%	31	41.9%	9	18.0%	18	31.6%	53	24.5%	186	32.5%
2と回答																		
男性	4	66.7%	9	50.0%	13	46.4%	25	58.1%	19	59.4%	13	59.1%	13	52.0%	59	59.6%	155	56.8%
女性	5	71.4%	5	45.5%	11	44.0%	17	44.7%	22	52.4%	22	78.6%	20	62.5%	68	58.1%	170	56.7%
男女合計	9	69.2%	14	48.3%	24	45.3%	42	51.9%	41	55.4%	35	70.0%	33	57.9%	127	58.8%	325	56.7%
3と回答																		
男性	0	0.0%	3	16.7%	1	3.6%	2	4.7%	0	0.0%	4	18.2%	3	12.0%	16	16.2%	29	10.6%
女性	1	14.3%	2	18.2%	0	0.0%	3	7.9%	2	4.8%	2	7.1%	3	9.4%	16	13.7%	29	9.7%
男女合計	1	7.7%	5	17.2%	1	1.9%	5	6.2%	2	2.7%	6	12.0%	6	10.5%	32	14.8%	58	10.1%
無回答																		
男性	0	0.0%	0	0.0%	0	0.0%	0	0.0%	0	0.0%	0	0.0%	0	0.0%	1	1.0%	1	0.4%
女性	0	0.0%	0	0.0%	0	0.0%	0	0.0%	0	0.0%	0	0.0%	0	0.0%	3	2.6%	3	1.0%
男女合計	0	0.0%	0	0.0%	0	0.0%	0	0.0%	0	0.0%	0	0.0%	0	0.0%	4	1.9%	4	0.7%
全体(人)																		
男性	6		18		28		43		32		22		25		99		273	
女性	7		11		25		38		42		28		32		117		300	
男女合計	13		29		53		81		74		50		57		216		573	

南 会 津

	10	割合	20	割合	30	割合	40	割合	50	割合	64	割合	69	割合	70～	割合	全体数	割合
1と回答																		
男性	0	0.0%	1	33.3%	2	100.0%	0	0.0%	1	33.3%	0	0.0%	0	0.0%	4	28.6%	8	26.7%
女性	0	0.0%	0	0.0%	1	50.0%	1	33.3%	1	100.0%	1	33.3%	2	50.0%	9	69.2%	15	57.7%
男女合計	0	0.0%	1	33.3%	3	75.0%	1	16.7%	2	50.0%	1	25.0%	2	25.0%	13	48.1%	23	41.1%
2と回答																		
男性	0	0.0%	2	66.7%	0	0.0%	3	100.0%	2	66.7%	1	100.0%	3	75.0%	7	50.0%	18	60.0%
女性	0	0.0%	0	0.0%	1	50.0%	2	66.7%	0	0.0%	2	66.7%	2	50.0%	4	30.8%	11	42.3%
男女合計	0	0.0%	2	66.7%	1	25.0%	5	83.3%	2	50.0%	3	75.0%	5	62.5%	11	40.7%	29	51.8%
3と回答																		
男性	0	0.0%	0	0.0%	0	0.0%	0	0.0%	0	0.0%	0	0.0%	1	25.0%	3	21.4%	4	13.3%
女性	0	0.0%	0	0.0%	0	0.0%	0	0.0%	0	0.0%	0	0.0%	0	0.0%	0	0.0%	0	0.0%
男女合計	0	0.0%	0	0.0%	0	0.0%	0	0.0%	0	0.0%	0	0.0%	1	12.5%	3	11.1%	4	7.1%
無回答																		
男性	0	0.0%	0	0.0%	0	0.0%	0	0.0%	0	0.0%	0	0.0%	0	0.0%	0	0.0%	0	0.0%
女性	0	0.0%	0	0.0%	0	0.0%	0	0.0%	0	0.0%	0	0.0%	0	0.0%	0	0.0%	0	0.0%
男女合計	0	0.0%	0	0.0%	0	0.0%	0	0.0%	0	0.0%	0	0.0%	0	0.0%	0	0.0%	0	0.0%
全体(人)																		
男性	0		3		2		3		3		1		4		14		30	
女性	0		0		2		3		1		3		4		13		26	
男女合計	0		3		4		6		4		4		8		27		56	

相 双

	10	割合	20	割合	30	割合	40	割合	50	割合	64	割合	69	割合	70～	割合	全体数	割合
1と回答																		
男性	1	16.7%	3	50.0%	3	25.0%	10	55.6%	11	55.0%	2	14.3%	7	35.0%	14	24.6%	51	33.3%
女性	1	16.7%	1	25.0%	4	28.6%	9	37.5%	12	60.0%	7	63.6%	8	42.1%	17	28.3%	59	37.3%
男女合計	2	16.7%	4	40.0%	7	26.9%	19	45.2%	23	57.5%	9	36.0%	15	38.5%	31	26.5%	110	35.4%
2と回答																		
男性	4	66.7%	2	33.3%	9	75.0%	8	44.4%	8	40.0%	11	78.6%	13	65.0%	39	68.4%	94	61.4%
女性	4	66.7%	3	75.0%	9	64.3%	15	62.5%	6	30.0%	4	36.4%	10	52.6%	38	63.3%	89	56.3%
男女合計	8	66.7%	5	50.0%	18	69.2%	23	54.8%	14	35.0%	15	60.0%	23	59.0%	77	65.8%	183	58.8%
3と回答																		
男性	0	0.0%	1	16.7%	0	0.0%	0	0.0%	1	5.0%	1	7.1%	0	0.0%	4	7.0%	7	4.6%
女性	0	0.0%	0	0.0%	1	7.1%	0	0.0%	2	10.0%	0	0.0%	1	5.3%	3	5.0%	7	4.4%
男女合計	0	0.0%	1	10.0%	1	3.8%	0	0.0%	3	7.5%	1	4.0%	1	2.6%	7	6.0%	14	4.5%
無回答																		
男性	1	16.7%	0	0.0%	0	0.0%	0	0.0%	0	0.0%	0	0.0%	0	0.0%	0	0.0%	1	0.7%
女性	1	16.7%	0	0.0%	0	0.0%	0	0.0%	0	0.0%	0	0.0%	0	0.0%	2	3.3%	3	1.9%
男女合計	2	16.7%	0	0.0%	0	0.0%	0	0.0%	0	0.0%	0	0.0%	0	0.0%	2	1.7%	4	1.3%
全体(人)																		
男性	6		6		12		18		20		14		20		57		153	
女性	6		4		14		24		20		11		19		60		158	
男女合計	12		10		26		42		40		25		39		117		311	

いわき

	10	割合	20	割合	30	割合	40	割合	50	割合	64	割合	69	割合	70～	割合	全体数	割合
1と回答																		
男性	3	23.1%	6	60.0%	16	45.7%	13	43.3%	11	22.9%	11	26.2%	14	31.1%	33	25.6%	107	30.4%
女性	4	25.0%	4	23.5%	14	50.0%	10	34.5%	22	34.9%	21	45.7%	10	23.3%	45	31.9%	130	33.9%
男女合計	7	24.1%	10	37.0%	30	47.6%	23	39.0%	33	29.7%	32	36.4%	24	27.3%	78	28.9%	237	32.2%
2と回答																		
男性	9	69.2%	3	30.0%	18	51.4%	14	46.7%	33	68.8%	31	73.8%	28	62.2%	82	63.6%	218	61.9%
女性	10	62.5%	12	70.6%	13	46.4%	18	62.1%	40	63.5%	21	45.7%	27	62.8%	79	56.0%	220	57.4%
男女合計	19	65.5%	15	55.6%	31	49.2%	32	54.2%	73	65.8%	52	59.1%	55	62.5%	161	59.6%	438	59.6%
3と回答																		
男性	1	7.7%	1	10.0%	1	2.9%	3	10.0%	4	8.3%	0	0.0%	3	6.7%	11	8.5%	24	6.8%
女性	2	12.5%	1	5.9%	1	3.6%	1	3.4%	1	1.6%	4	8.7%	6	14.0%	16	11.3%	32	8.4%
男女合計	3	10.3%	2	7.4%	2	3.2%	4	6.8%	5	4.5%	4	4.5%	9	10.2%	27	10.0%	56	7.6%
無回答																		
男性	0	0.0%	0	0.0%	0	0.0%	0	0.0%	0	0.0%	0	0.0%	0	0.0%	3	2.3%	3	0.9%
女性	0	0.0%	0	0.0%	0	0.0%	0	0.0%	0	0.0%	0	0.0%	0	0.0%	1	0.7%	1	0.3%
男女合計	0	0.0%	0	0.0%	0	0.0%	0	0.0%	0	0.0%	0	0.0%	0	0.0%	4	1.5%	4	0.5%
全体(人)																		
男性	13		10		35		30		48		42		45		129		352	
女性	16		17		28		29		63		46		43		141		383	
男女合計	29		27		63		59		111		88		88		270		735	

全県(60歳以上・再掲)

	64	割合	69	割合	70	割合	80	割合	90	割合	全体数	割合
1と回答												
男性	60	30.6%	64	30.3%	113	26.2%	40	21.4%	12	27.9%	289	27.0%
女性	75	36.1%	73	33.0%	130	30.6%	90	32.5%	21	28.8%	389	32.3%
男女合計	135	33.4%	137	31.7%	243	28.4%	130	28.0%	33	28.4%	678	29.8%
2と回答												
男性	121	61.7%	136	64.5%	276	63.9%	119	63.6%	24	55.8%	676	63.2%
女性	121	58.2%	128	57.9%	257	60.5%	152	54.9%	35	47.9%	693	57.6%
男女合計	242	59.9%	264	61.1%	533	62.2%	271	58.4%	59	50.9%	1369	60.2%
3と回答												
男性	14	7.1%	11	5.2%	39	9.0%	24	12.8%	7	16.3%	95	8.9%
女性	11	5.3%	19	8.6%	32	7.5%	27	9.7%	13	17.8%	102	8.5%
男女合計	25	6.2%	30	6.9%	71	8.3%	51	11.0%	20	17.2%	197	8.7%
無回答												
男性	1	0.5%	0	0.0%	4	0.9%	4	2.1%	0	0.0%	9	0.8%
女性	1	0.5%	1	0.5%	6	1.4%	8	2.9%	4	5.5%	20	1.7%
男女合計	2	0.5%	1	0.2%	10	1.2%	12	2.6%	4	3.4%	29	1.3%
全体(人)												
男性	196		211		432		187		43		1069	
女性	208		221		425		277		73		1204	
男女合計	404		432		857		464		116		2273	

23 健康づくりのために必要と考えること（調査票 問23）

問23 あなたは、健康づくりのために何が必要だと考えていますか。
（記述式 自由回答）

調査回答者4,212人中2,220人から回答があった。

	全 体		男 性		女 性	
問23回答者数	2,220	52.7%	1,006	49.9%	1,214	55.3%
調査回答者数	4,212		2,016		2,196	

- 1 「食生活（栄養バランス）」が必要と回答した人
（他の分野（「運動」、「休養、こころの健康」等）との重複回答を含む。集計は、問23の回答者2,220人に対する割合を示す。以下の集計においても同じ）

	10	割合	20	割合	30	割合	40	割合	50	割合	64	割合	69	割合	70	割合	80	割合	90	割合	全体数	割合
男 性	20	51.3%	32	52.5%	41	42.7%	52	41.6%	68	43.6%	38	40.9%	59	55.7%	97	42.2%	37	41.1%	3	30.0%	447	44.4%
女 性	33	64.7%	42	59.2%	55	52.4%	77	47.0%	102	50.0%	65	54.2%	68	54.4%	116	47.7%	59	50.9%	8	53.3%	625	51.5%
男女合計	53	58.9%	74	56.1%	96	47.8%	129	44.6%	170	47.2%	103	48.4%	127	55.0%	213	45.0%	96	46.6%	11	44.0%	1072	48.3%
全体(人)																						
男 性	39		61		96		125		156		93		106		230		90		10		1006	
女 性	51		71		105		164		204		120		125		243		116		15		1214	
男女合計	90		132		201		289		360		213		231		473		206		25		2220	

- 2 「運動（スポーツ、ウォーキング等）」が必要と回答した人

	10	割合	20	割合	30	割合	40	割合	50	割合	64	割合	69	割合	70	割合	80	割合	90	割合	全体数	割合
男 性	23	59.0%	32	52.5%	59	61.5%	78	62.4%	101	64.7%	60	64.5%	69	65.1%	159	69.1%	60	66.7%	7	70.0%	648	64.4%
女 性	32	62.7%	45	63.4%	73	69.5%	110	67.1%	143	70.1%	85	70.8%	87	69.6%	157	64.6%	74	63.8%	10	66.7%	816	67.2%
男女合計	55	61.1%	77	58.3%	132	65.7%	188	65.1%	244	67.8%	145	68.1%	156	67.5%	316	66.8%	134	65.0%	17	68.0%	1464	65.9%
全体(人)																						
男 性	39		61		96		125		156		93		106		230		90		10		1006	
女 性	51		71		105		164		204		120		125		243		116		15		1214	
男女合計	90		132		201		289		360		213		231		473		206		25		2220	

- 3 「休養、こころの健康（睡眠、ストレス解消等）」が必要と回答した人

	10	割合	20	割合	30	割合	40	割合	50	割合	64	割合	69	割合	70	割合	80	割合	90	割合	全体数	割合
男 性	14	35.9%	23	37.7%	36	37.5%	40	32.0%	38	24.4%	25	26.9%	24	22.6%	45	19.6%	17	18.9%	0	0.0%	262	26.0%
女 性	21	41.2%	39	54.9%	45	42.9%	61	37.2%	72	35.3%	45	37.5%	46	36.8%	69	28.4%	24	20.7%	3	20.0%	425	35.0%
男女合計	35	38.9%	62	47.0%	81	40.3%	101	34.9%	110	30.6%	70	32.9%	70	30.3%	114	24.1%	41	19.9%	3	12.0%	687	30.9%
全体(人)																						
男 性	39		61		96		125		156		93		106		230		90		10		1006	
女 性	51		71		105		164		204		120		125		243		116		15		1214	
男女合計	90		132		201		289		360		213		231		473		206		25		2220	

- 4 「規則正しい生活習慣」が必要と回答した人

	10	割合	20	割合	30	割合	40	割合	50	割合	64	割合	69	割合	70	割合	80	割合	90	割合	全体数	割合
男 性	8	20.5%	5	8.2%	8	8.3%	10	8.0%	10	6.4%	4	4.3%	10	9.4%	13	5.7%	7	7.8%	1	10.0%	76	7.6%
女 性	3	5.9%	4	5.6%	6	5.7%	9	5.5%	13	6.4%	10	8.3%	11	8.8%	25	10.3%	7	6.0%	3	20.0%	91	7.5%
男女合計	11	12.2%	9	6.8%	14	7.0%	19	6.6%	23	6.4%	14	6.6%	21	9.1%	38	8.0%	14	6.8%	4	16.0%	167	7.5%
全体(人)																						
男 性	39		61		96		125		156		93		106		230		90		10		1006	
女 性	51		71		105		164		204		120		125		243		116		15		1214	
男女合計	90		132		201		289		360		213		231		473		206		25		2220	

5 「検査・健診」が必要と回答した人

	10	割合	20	割合	30	割合	40	割合	50	割合	64	割合	69	割合	70	割合	80	割合	90	割合	全体数	割合
男性	0	0.0%	0	0.0%	4	4.2%	2	1.6%	4	2.6%	5	5.4%	6	5.7%	6	2.6%	2	2.2%	0	0.0%	29	2.9%
女性	1	2.0%	2	2.8%	3	2.9%	3	1.8%	9	4.4%	3	2.5%	5	4.0%	7	2.9%	2	1.7%	0	0.0%	35	2.9%
男女合計	1	1.1%	2	1.5%	7	3.5%	5	1.7%	13	3.6%	8	3.8%	11	4.8%	13	2.7%	4	1.9%	0	0.0%	64	2.9%
全体(人)																						
男性	39		61		96		125		156		93		106		230		90		10		1006	
女性	51		71		105		164		204		120		125		243		116		15		1214	
男女合計	90		132		201		289		360		213		231		473		206		25		2220	

6 「禁煙」が必要と回答した人

	10	割合	20	割合	30	割合	40	割合	50	割合	64	割合	69	割合	70	割合	80	割合	90	割合	全体数	割合
男性	0	0.0%	1	1.6%	3	3.1%	2	1.6%	7	4.5%	1	1.1%	5	4.7%	2	0.9%	2	2.2%	0	0.0%	23	2.3%
女性	2	3.9%	2	2.8%	0	0.0%	2	1.2%	3	1.5%	1	0.8%	2	1.6%	2	0.8%	0	0.0%	1	6.7%	15	1.2%
男女合計	2	2.2%	3	2.3%	3	1.5%	4	1.4%	10	2.8%	2	0.9%	7	3.0%	4	0.8%	2	1.0%	1	4.0%	38	1.7%
全体(人)																						
男性	39		61		96		125		156		93		106		230		90		10		1006	
女性	51		71		105		164		204		120		125		243		116		15		1214	
男女合計	90		132		201		289		360		213		231		473		206		25		2220	

7 「その他」が必要と回答した人

	10	割合	20	割合	30	割合	40	割合	50	割合	64	割合	69	割合	70	割合	80	割合	90	割合	全体数	割合
男性	3	7.7%	16	26.2%	24	25.0%	32	25.6%	48	30.8%	28	30.1%	33	31.1%	76	33.0%	31	34.4%	3	30.0%	294	29.2%
女性	7	13.7%	18	25.4%	33	31.4%	48	29.3%	69	33.8%	43	35.8%	50	40.0%	102	42.0%	41	35.3%	6	40.0%	417	34.3%
男女合計	10	11.1%	34	25.8%	57	28.4%	80	27.7%	117	32.5%	71	33.3%	83	35.9%	178	37.6%	72	35.0%	9	36.0%	711	32.0%
全体(人)																						
男性	39		61		96		125		156		93		106		230		90		10		1006	
女性	51		71		105		164		204		120		125		243		116		15		1214	
男女合計	90		132		201		289		360		213		231		473		206		25		2220	

24 自由回答（調査票 問24）

問24 全体をとおして気づかれた点について、御自由にお書きください。
（記述式 自由回答）

調査回答者4,212人中832人から回答があった。

	全 体		男 性		女 性	
問24回答者数	832	19.8%	329	16.3%	503	22.9%
調査回答者数	4,212		2,016		2,196	

第3章 前回調査結果との比較 (満15歳以上対象)

1 健康についての意識 (調査票 問1の集計結果)

問1 あなたは、ふだん自分で健康だと思えますか。

(あてはまる番号1つに○)

1 非常に健康だと思う	2 まあ健康な方だと思う
3 あまり健康ではない	4 健康ではない

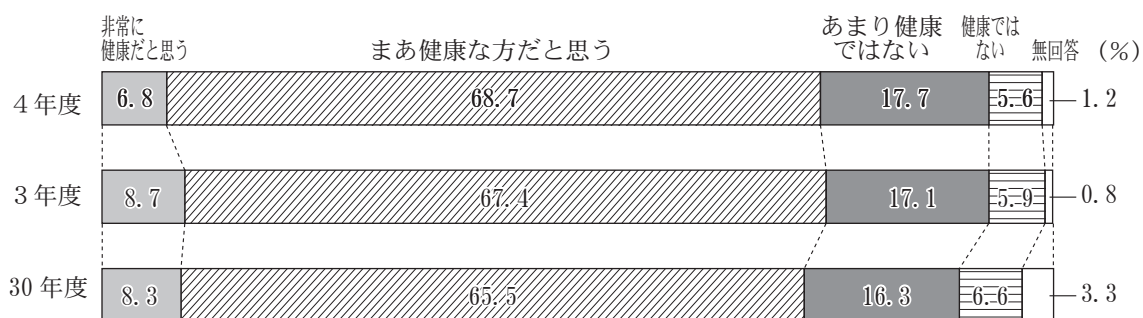

	R 4		R 3		H30	
	人数(人)	割合(%)	人数(人)	割合(%)	人数(人)	割合(%)
1と回答						
男性	141	7.0	238	9.0	191	9.6
女性	147	6.7	238	8.5	145	7.0
男女合計	288	6.8	476	8.7	336	8.3
2と回答						
男性	1,363	67.6	1,750	65.9	1,271	63.9
女性	1,530	69.7	1,936	68.9	1,394	67.1
男女合計	2,893	68.7	3,686	67.4	2,665	65.5
3と回答						
男性	374	18.6	484	18.2	331	16.6
女性	370	16.8	453	16.1	333	16.0
男女合計	744	17.7	937	17.1	664	16.3
4と回答						
男性	117	5.8	163	6.1	128	6.4
女性	120	5.5	162	5.8	139	6.7
男女合計	237	5.6	325	5.9	267	6.6
無回答						
男性	21	1.0	21	0.8	67	3.4
女性	29	1.3	22	0.8	67	3.2
男女合計	50	1.2	43	0.8	134	3.3
全体(人)						
男性	2,016		2,656		1,988	
女性	2,196		2,811		2,078	
男女合計	4,212		5,467		4,066	

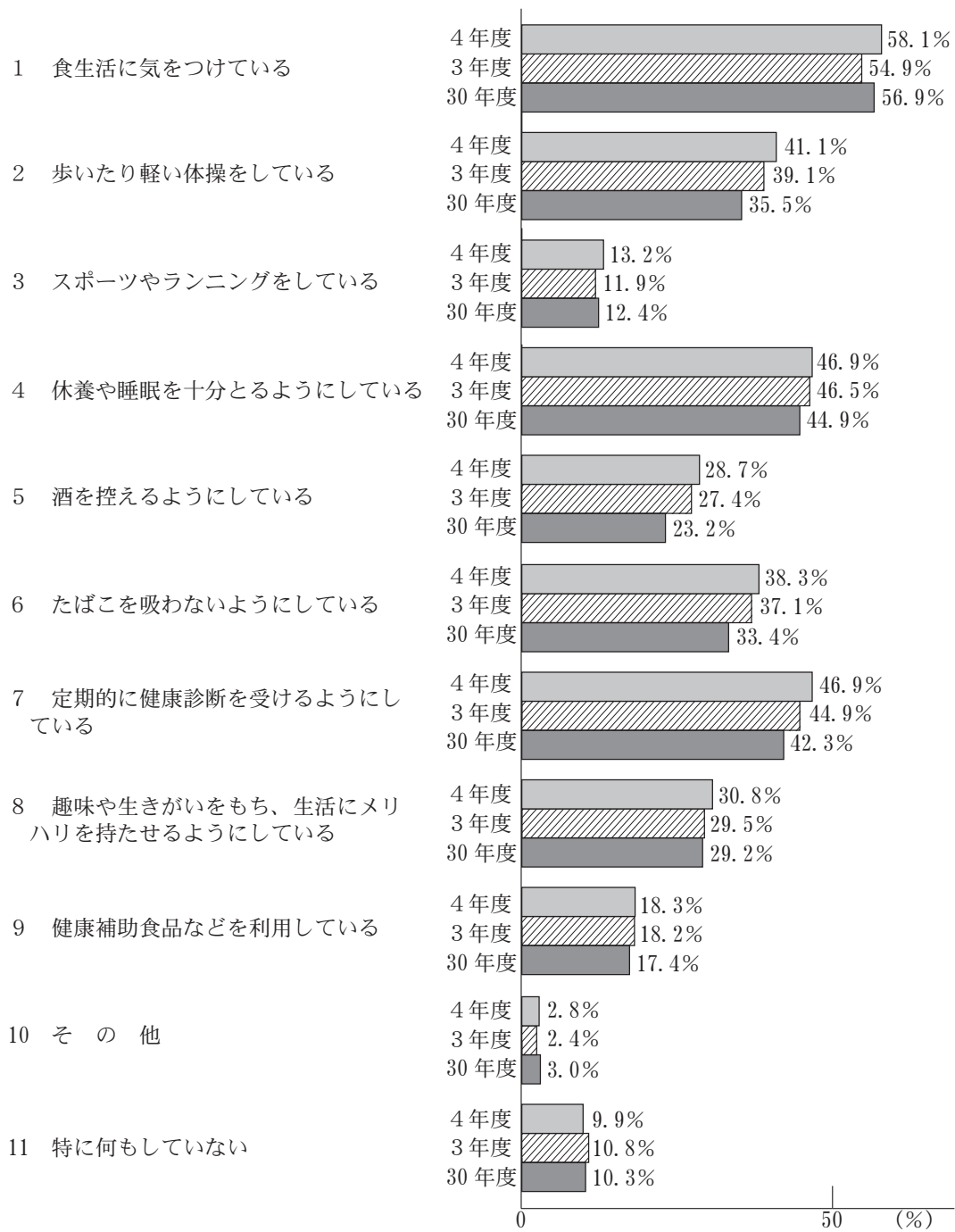

	R 4		R 3		H30	
	人数(人)	割合(%)	人数(人)	割合(%)	人数(人)	割合(%)
1 と回答						
男性	1,069	53.0	1,330	50.1	1,012	50.9
女性	1,379	62.8	1,671	59.4	1,302	62.7
男女合計	2,448	58.1	3,001	54.9	2,314	56.9
2 と回答						
男性	787	39.0	1,023	38.5	669	33.7
女性	945	43.0	1,114	39.6	773	37.2
男女合計	1,732	41.1	2,137	39.1	1,442	35.5
3 と回答						
男性	362	18.0	425	16.0	315	15.8
女性	196	8.9	223	7.9	191	9.2
男女合計	558	13.2	648	11.9	506	12.4
4 と回答						
男性	909	45.1	1,192	44.9	822	41.3
女性	1,068	48.6	1,349	48.0	1,002	48.2
男女合計	1,977	46.9	2,541	46.5	1,824	44.9
5 と回答						
男性	596	29.6	780	29.4	473	23.8
女性	611	27.8	717	25.5	471	22.7
男女合計	1,207	28.7	1,497	27.4	944	23.2
6 と回答						
男性	853	42.3	1,085	40.9	741	37.3
女性	759	34.6	941	33.5	617	29.7
男女合計	1,612	38.3	2,026	37.1	1,358	33.4
7 と回答						
男性	967	48.0	1,199	45.1	838	42.2
女性	1,009	45.9	1,256	44.7	880	42.3
男女合計	1,976	46.9	2,455	44.9	1,718	42.3
8 と回答						
男性	602	29.9	749	28.2	528	26.6
女性	694	31.6	862	30.7	658	31.7
男女合計	1,296	30.8	1,611	29.5	1,186	29.2
9 と回答						
男性	310	15.4	380	14.3	289	14.5
女性	462	21.0	616	21.9	419	20.2
男女合計	772	18.3	996	18.2	708	17.4
10 と回答						
男性	61	3.0	64	2.4	52	2.6
女性	55	2.5	65	2.3	69	3.3
男女合計	116	2.8	129	2.4	121	3.0
11 と回答						
男性	221	11.0	297	11.2	210	10.6
女性	196	8.9	291	10.4	208	10.0
男女合計	417	9.9	588	10.8	418	10.3
全体(人)						
男性	2,016		2,656		1,988	
女性	2,196		2,811		2,078	
男女合計	4,212		5,467		4,066	

3 「県民健康の日」の認知度（調査票 問3の集計結果）

問3 あなたは、福島県において、10月10日が「県民健康の日」であることを知っていますか。

1 知っている 2 知らない

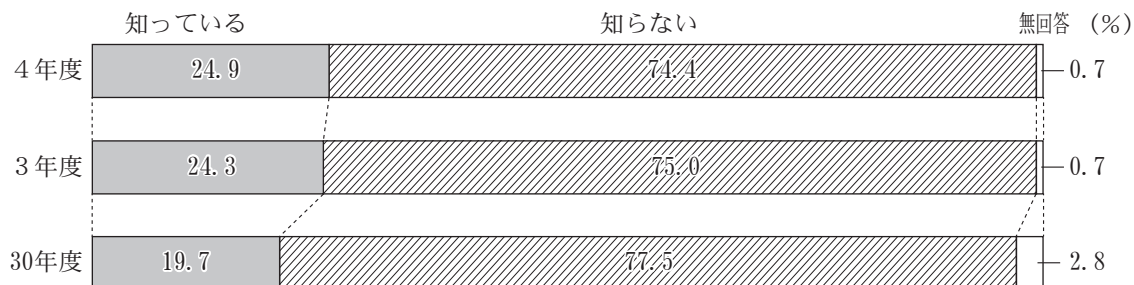

	R 4		R 3		H30	
	人数(人)	割合(%)	人数(人)	割合(%)	人数(人)	割合(%)
1と回答						
男性	475	23.6	611	23.0	357	18.0
女性	573	26.1	717	25.5	444	21.4
男女合計	1,048	24.9	1,328	24.3	801	19.7
2と回答						
男性	1,532	76.0	2,037	76.7	1,579	79.4
女性	1,601	72.9	2,062	73.4	1,572	75.6
男女合計	3,133	74.4	4,099	75.0	3,151	77.5
無回答						
男性	9	0.4	8	0.3	52	2.6
女性	22	1.0	32	1.1	62	3.0
男女合計	31	0.7	40	0.7	114	2.8
全体(人)						
男性	2,016		2,656		1,988	
女性	2,196		2,811		2,078	
男女合計	4,212		5,467		4,066	

4 食生活（朝食）の状況（調査票 問4の集計結果）

問4 あなたは、朝食をだいたい毎日とっていますか。

1 はい 2 いいえ

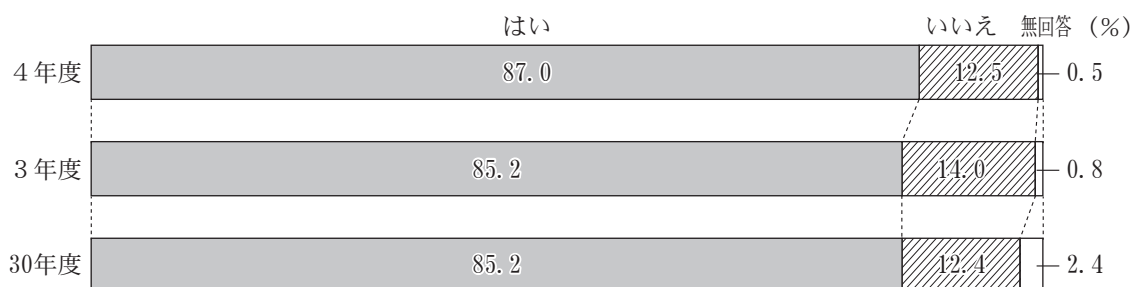

	R 4		R 3		H30	
	人数(人)	割合(%)	人数(人)	割合(%)	人数(人)	割合(%)
1 と回答						
男性	1,677	83.2	2,194	82.6	1,636	82.3
女性	1,987	90.5	2,465	87.7	1,829	88.0
男女合計	3,664	87.0	4,659	85.2	3,465	85.2
2 と回答						
男性	326	16.2	438	16.5	301	15.1
女性	201	9.2	326	11.6	204	9.8
男女合計	527	12.5	764	14.0	505	12.4
無回答						
男性	13	0.6	24	0.9	51	2.6
女性	8	0.4	20	0.7	45	2.2
男女合計	21	0.5	44	0.8	96	2.4
全体(人)						
男性	2,016		2,656		1,988	
女性	2,196		2,811		2,078	
男女合計	4,212		5,467		4,066	

5 食生活（朝食・夕食）の状況（調査票 問5の集計結果）

問5 あなたは、朝食、夕食を家族とどのくらい一緒に食べていますか。

1. ほとんど毎日	2. 週に4～5日
3. 週に2～3日	4. 週に1日程度
5. ほとんどひとり	

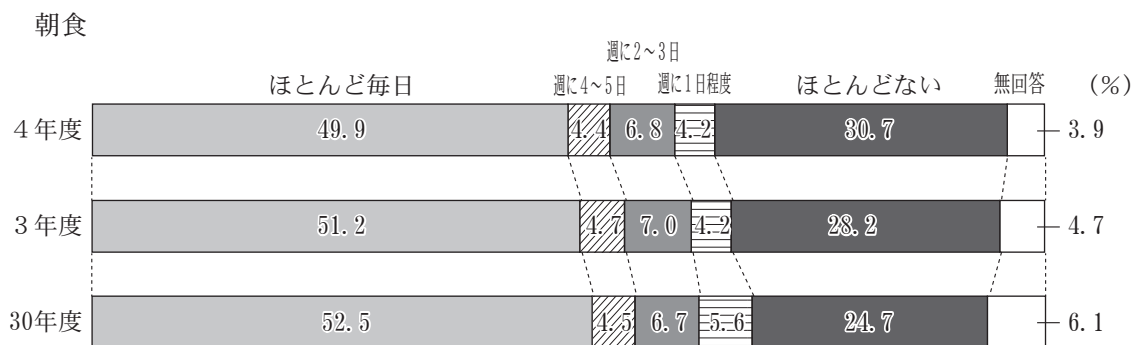

	R 4		R 3		H30	
	人数(人)	割合(%)	人数(人)	割合(%)	人数(人)	割合(%)
1と回答						
男性	981	48.7	1,350	50.8	1,032	51.9
女性	1,121	51.0	1,447	51.5	1,102	53.0
男女合計	2,102	49.9	2,797	51.2	2,134	52.5
2と回答						
男性	98	4.9	124	4.7	97	4.9
女性	87	4.0	135	4.8	84	4.0
男女合計	185	4.4	259	4.7	181	4.5
3と回答						
男性	144	7.1	176	6.6	135	6.8
女性	143	6.5	204	7.3	136	6.5
男女合計	287	6.8	380	7.0	271	6.7
4と回答						
男性	92	4.6	122	4.6	121	6.1
女性	86	3.9	109	3.9	108	5.2
男女合計	178	4.2	231	4.2	229	5.6
5と回答						
男性	611	30.3	741	27.9	497	25.0
女性	684	31.1	803	28.6	507	24.4
男女合計	1,295	30.7	1,544	28.2	1,004	24.7
無回答						
男性	90	4.5	143	5.4	106	5.3
女性	75	3.4	113	4.0	141	6.8
男女合計	165	3.9	256	4.7	247	6.1
全体(人)						
男性	2,016		2,656		1,988	
女性	2,196		2,811		2,078	
男女合計	4,212		5,467		4,066	

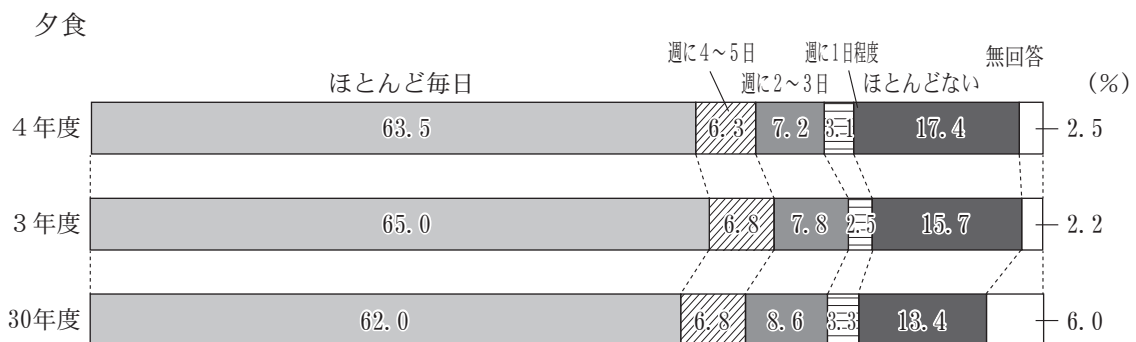

	R 4		R 3		H30	
	人数(人)	割合(%)	人数(人)	割合(%)	人数(人)	割合(%)
1 と回答						
男性	1,208	59.9	1,662	62.6	1,177	59.2
女性	1,468	66.8	1,894	67.4	1,343	64.6
男女合計	2,676	63.5	3,556	65.0	2,520	62.0
2 と回答						
男性	149	7.4	194	7.3	155	7.8
女性	117	5.3	178	6.3	121	5.8
男女合計	266	6.3	372	6.8	276	6.8
3 と回答						
男性	173	8.6	250	9.4	206	10.4
女性	131	6.0	176	6.3	143	6.9
男女合計	304	7.2	426	7.8	349	8.6
4 と回答						
男性	73	3.6	86	3.2	82	4.1
女性	56	2.6	50	1.8	52	2.5
男女合計	129	3.1	136	2.5	134	3.3
5 と回答						
男性	363	18.0	409	15.4	259	13.0
女性	368	16.8	450	16.0	284	13.7
男女合計	731	17.4	859	15.7	543	13.4
無回答						
男性	50	2.5	55	2.1	109	5.5
女性	56	2.6	63	2.2	135	6.5
男女合計	106	2.5	118	2.2	244	6.0
全体(人)						
男性	2,016		2,656		1,988	
女性	2,196		2,811		2,078	
男女合計	4,212		5,467		4,066	

6 「食育推進月間」「食育の日」の認知度（調査票 問6の集計結果）

問6 あなたは、食育推進月間（6月）と食育の日（毎月19日）を知っていますか。

（あてはまる番号1つに○）

1 知っている
2 名称は知っているが、月日までは知らない
3 知らない

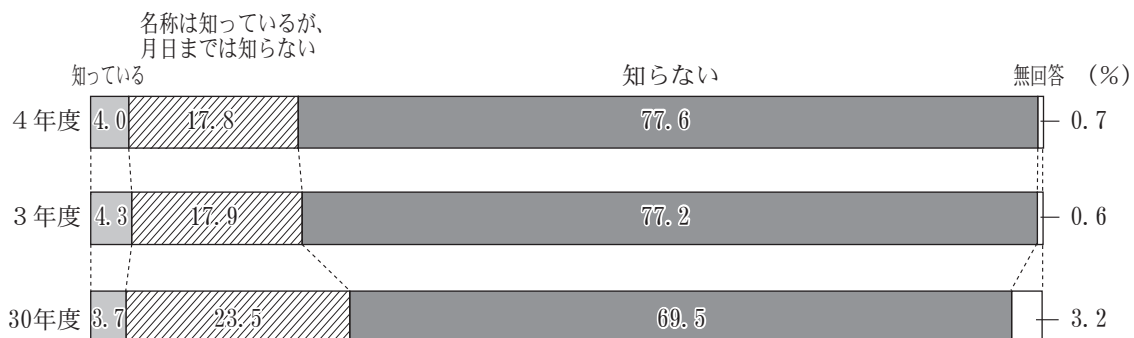

	R 4		R 3		H30	
	人数(人)	割合(%)	人数(人)	割合(%)	人数(人)	割合(%)
1 と回答						
男性	59	2.9	86	3.2	50	2.5
女性	109	5.0	148	5.3	102	4.9
男女合計	168	4.0	234	4.3	152	3.7
2 と回答						
男性	254	12.6	349	13.1	338	17
女性	494	22.5	632	22.5	617	29.7
男女合計	748	17.8	981	17.9	955	23.5
3 と回答						
男性	1,693	84.0	2,211	83.2	1,540	77.5
女性	1,574	71.7	2,009	71.5	1,287	61.9
男女合計	3,267	77.6	4,220	77.2	2,827	69.5
無回答						
男性	10	0.5	10	0.4	60	3.0
女性	19	0.9	22	0.8	72	3.5
男女合計	29	0.7	32	0.6	132	3.2
全体(人)						
男性	2,016		2,656		1,988	
女性	2,196		2,811		2,078	
男女合計	4,212		5,467		4,066	

7 食生活（栄養バランス）の状況（調査票 問7の調査結果）

問7 あなたは、日頃から栄養バランスのとれた食生活を実践していますか。

1 はい	2 いいえ
------	-------

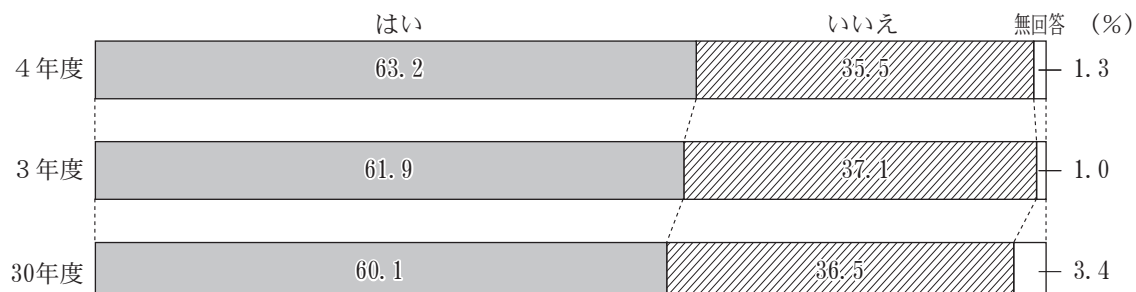

	R 4		R 3		H30	
	人数(人)	割合(%)	人数(人)	割合(%)	人数(人)	割合(%)
1 と回答						
男性	1,179	58.5	1,516	57.1	1,088	54.7
女性	1,484	67.6	1,867	66.4	1,354	65.2
男女合計	2,663	63.2	3,383	61.9	2,442	60.1
2 と回答						
男性	815	40.4	1,122	42.2	834	42.0
女性	679	30.9	905	32.2	651	31.3
男女合計	1,494	35.5	2,027	37.1	1,485	36.5
無回答						
男性	22	1.1	18	0.7	66	3.3
女性	33	1.5	39	1.4	73	3.5
男女合計	55	1.3	57	1.0	139	3.4
全体(人)						
男性	2,016		2,656		1,988	
女性	2,196		2,811		2,078	
男女合計	4,212		5,467		4,066	

8 「フレイル」の認知度（調査票 問8の調査結果）

問8 あなたは、フレイルを知っていますか。

1 知っている	2 知らない
---------	--------

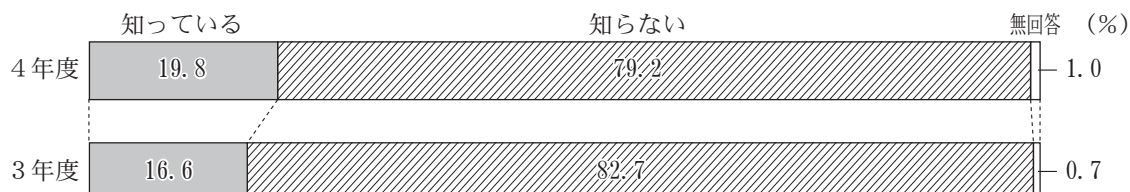

	R 4		R 3	
	人数(人)	割合(%)	人数(人)	割合(%)
1 と回答				
男性	300	14.9	306	11.5
女性	535	24.4	599	21.3
男女合計	835	19.8	905	16.6
2 と回答				
男性	1,703	84.5	2,340	88.1
女性	1,631	74.3	2,181	77.6
男女合計	3,334	79.2	4,521	82.7
無回答				
男性	13	0.6	10	0.4
女性	30	1.4	31	1.1
男女合計	43	1.0	41	0.7
全体(人)				
男性	2,016		2,656	
女性	2,196		2,811	
男女合計	4,212		5,467	

9 「ロコモティブシンドローム」の認知度（調査票 問9の調査結果）

問9 あなたは、ロコモティブシンドローム（運動器症候群）を知っていますか。

1 知っている	2 知らない
---------	--------

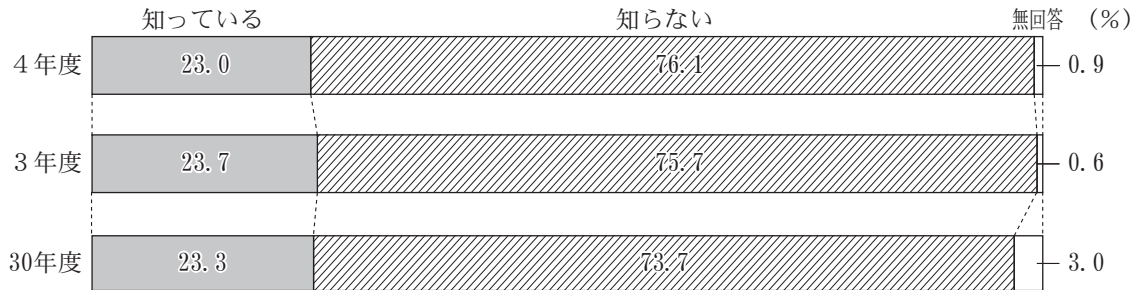

	R 4		R 3		H30	
	人数(人)	割合(%)	人数(人)	割合(%)	人数(人)	割合(%)
1と回答						
男性	333	16.5	430	16.2	325	16.3
女性	636	29.0	867	30.8	622	29.9
男女合計	969	23.0	1,297	23.7	947	23.3
2と回答						
男性	1,668	82.7	2,218	83.5	1,606	80.8
女性	1,539	70.1	1,921	68.3	1,390	66.9
男女合計	3,207	76.1	4,139	75.7	2,996	73.7
無回答						
男性	15	0.7	8	0.3	57	2.9
女性	21	1.0	23	0.8	66	3.2
男女合計	36	0.9	31	0.6	123	3.0
全体(人)						
男性	2,016		2,656		1,988	
女性	2,196		2,811		2,078	
男女合計	4,212		5,467		4,066	

10 最近1年間の運動状況

(1) 最近1年間の運動状況 (調査票 問10の調査結果)

問10 最近1年間の運動について、あてはまるものを1つ選んで○をつけてください。

- 1 何らかの運動をほとんど毎日している。(付問へ)
- 2 何らかの運動を週2～4回程度している。(付問へ)
- 3 何らかの運動を週1回程度している。(付問へ)
- 4 ほとんど(まったく)していない。

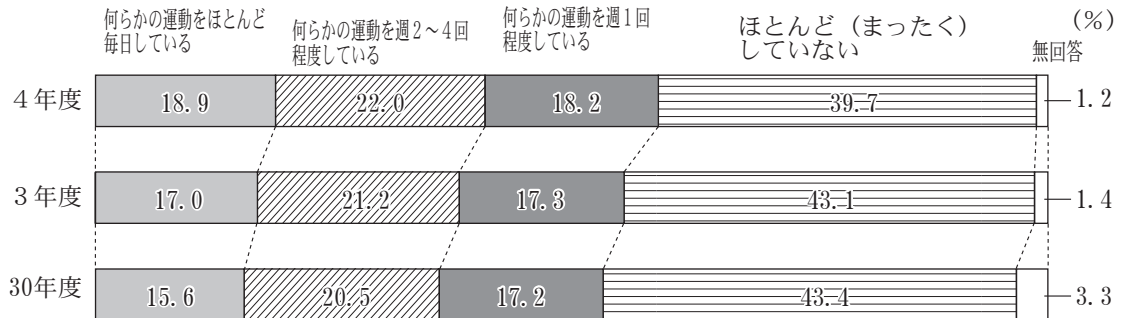

	R 4		R 3		H30	
	人数(人)	割合(%)	人数(人)	割合(%)	人数(人)	割合(%)
1と回答						
男性	427	21.2	476	17.9	357	18.0
女性	371	16.9	456	16.2	279	13.4
男女合計	798	18.9	932	17.0	636	15.6
2と回答						
男性	438	21.7	574	21.6	393	19.8
女性	490	22.3	586	20.8	440	21.2
男女合計	928	22.0	1,160	21.2	833	20.5
3と回答						
男性	372	18.5	446	16.8	343	17.3
女性	393	17.9	500	17.8	357	17.2
男女合計	765	18.2	946	17.3	700	17.2
4と回答						
男性	763	37.8	1,136	42.8	831	41.8
女性	909	41.4	1,219	43.4	933	44.9
男女合計	1,672	39.7	2,355	43.1	1,764	43.4
無回答						
男性	16	0.8	24	0.9	64	3.2
女性	33	1.5	50	1.8	69	3.3
男女合計	49	1.2	74	1.4	133	3.3
全体(人)						
男性	2,016		2,656		1,988	
女性	2,196		2,811		2,078	
男女合計	4,212		5,467		4,066	

(2) 運動時間 (調査票 問10付問の調査結果)

付問 問10で1～3を選んだ方におたずねします。

1回の運動時間はどれくらいですか。複数の運動をしている方は、もっとも運動時間の長いものについてお答えください。

1	15分未満	2	15～30分未満	3	30分以上
---	-------	---	----------	---	-------

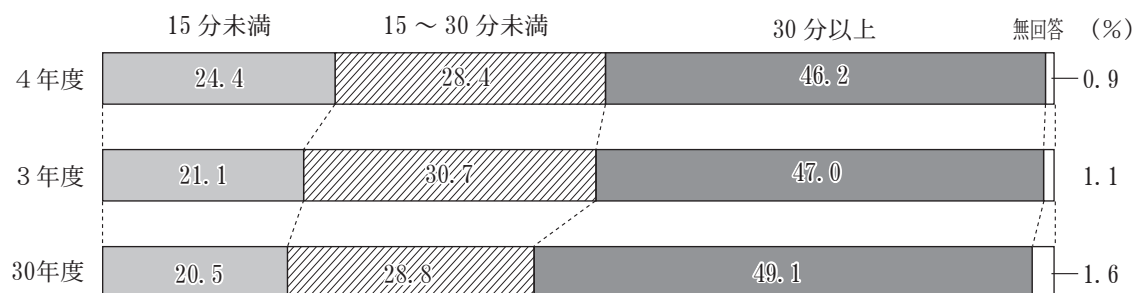

	R 4		R 3		H30	
	人数(人)	割合(%)	人数(人)	割合(%)	人数(人)	割合(%)
1と回答						
男性	235	19.0	244	16.3	174	15.9
女性	373	29.7	398	25.8	271	25.2
男女合計	608	24.4	642	21.1	445	20.5
2と回答						
男性	334	27.0	409	27.3	307	28.1
女性	374	29.8	525	34.0	318	29.6
男女合計	708	28.4	934	30.7	625	28.8
3と回答						
男性	659	53.3	829	55.4	594	54.3
女性	493	39.3	599	38.8	471	43.8
男女合計	1,152	46.2	1,428	47.0	1,065	49.1
無回答						
男性	9	0.7	14	0.9	18	1.6
女性	14	1.1	20	1.3	16	1.5
男女合計	23	0.9	34	1.1	34	1.6
全体(人)						
男性	1,237		1,496		1,093	
女性	1,254		1,542		1,076	
男女合計	2,491		3,038		2,169	

(3) 運動習慣の状況（満20歳以上対象）（調査票 問10、問10付問の回答に関するクロス集計）

運動習慣について

- | |
|----------------------------|
| 1 何らかの運動をほとんど毎日、30分以上している |
| 2 何らかの運動を週2～4回程度、30分以上している |

	R 4		R 3		H30	
	人数(人)	割合(%)	人数(人)	割合(%)	人数(人)	割合(%)
1 と回答						
男性	209	10.8	247	9.7	173	9.0
女性	136	6.4	166	6.2	103	5.1
男女合計	345	8.5	413	7.9	276	7.0
2 と回答						
男性	238	12.3	301	11.9	207	10.8
女性	186	8.8	218	8.1	192	9.6
男女合計	424	10.5	519	9.9	399	10.2
全体(人)						
男性	1,934		2,537		1,912	
女性	2,122		2,687		2,010	
男女合計	4,056		5,224		3,922	

11 喫煙の状況

(1) 喫煙の有無（満20歳以上対象）（調査票 問11の集計結果）

問11 あなたは、たばこを吸っていますか。（あてはまる番号1つに○）

20歳以上の方のみお答えください。

- | | |
|---------------------|----------------|
| 1 毎日吸う（付問へ） | 2 時々吸う（付問へ） |
| 3 今は吸っていない（禁煙に成功した） | 4 習慣的に吸ったことがない |

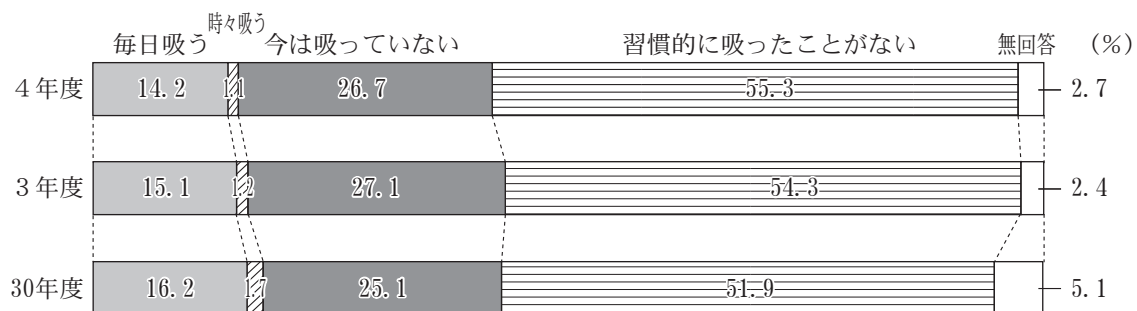

	R 4		R 3		H30	
	人数(人)	割合(%)	人数(人)	割合(%)	人数(人)	割合(%)
1と回答						
男性	444	23.0	612	24.1	502	26.3
女性	131	6.2	175	6.5	132	6.6
男女合計	575	14.2	787	15.1	634	16.2
2と回答						
男性	32	1.7	46	1.8	52	2.7
女性	12	0.6	15	0.6	15	0.7
男女合計	44	1.1	61	1.2	67	1.7
3と回答						
男性	847	43.8	1,102	43.4	768	40.2
女性	237	11.2	313	11.6	216	10.7
男女合計	1,084	26.7	1,415	27.1	984	25.1
4と回答						
男性	590	30.5	750	29.6	523	27.4
女性	1,653	77.9	2,085	77.6	1,513	75.3
男女合計	2,243	55.3	2,835	54.3	2,036	51.9
無回答						
男性	21	1.1	27	1.1	67	3.5
女性	89	4.2	99	3.7	134	6.7
男女合計	110	2.7	126	2.4	201	5.1
全体(人)						
男性	1,934		2,537		1,912	
女性	2,122		2,687		2,010	
男女合計	4,056		5,224		3,922	

(2) 禁煙の意思 (満20歳以上対象) (調査票 問11付問の調査結果)

付問 問11で1～2を選んだ方におたずねします。あなたは、たばこをやめたいと思いますか。

(あてはまる番号1つに○)

1 やめたい	2 本数を減らしたい
3 やめたくない	4 わからない

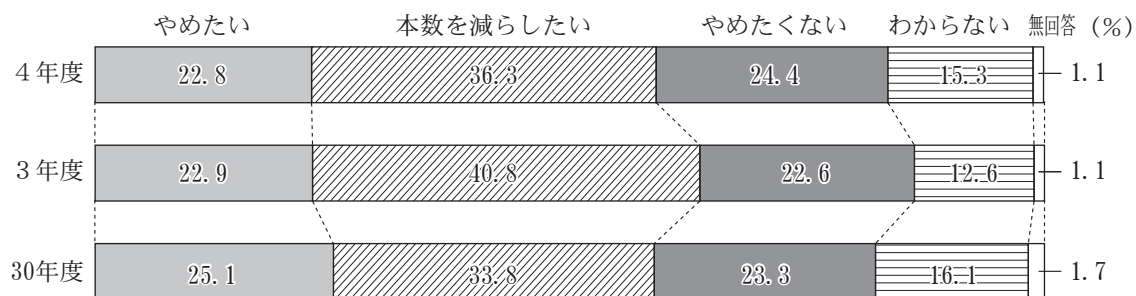

	R 4		R 3		H30	
	人数(人)	割合(%)	人数(人)	割合(%)	人数(人)	割合(%)
1 と回答						
男性	101	21.2	131	19.9	129	23.3
女性	40	28.0	63	33.2	47	32.0
男女合計	141	22.8	194	22.9	176	25.1
2 と回答						
男性	184	38.7	282	42.9	203	36.6
女性	41	28.7	64	33.7	34	23.1
男女合計	225	36.3	346	40.8	237	33.8
3 と回答						
男性	119	25.0	157	23.9	129	23.3
女性	32	22.4	35	18.4	34	23.1
男女合計	151	24.4	192	22.6	163	23.3
4 と回答						
男性	67	14.1	81	12.3	84	15.2
女性	28	19.6	26	13.7	29	19.7
男女合計	95	15.3	107	12.6	113	16.1
無回答						
男性	5	1.1	7	1.1	9	1.6
女性	2	1.4	2	1.1	3	2.0
男女合計	7	1.1	9	1.1	12	1.7
全体(人)						
男性	476		658		554	
女性	143		190		147	
男女合計	619		848		701	

(3) 家族（世帯）の喫煙状況（調査票 問12の集計結果）

問12 あなたの家族で、あなたを含めて、たばこを吸っている方はいますか。

1 いる	2 いない
------	-------

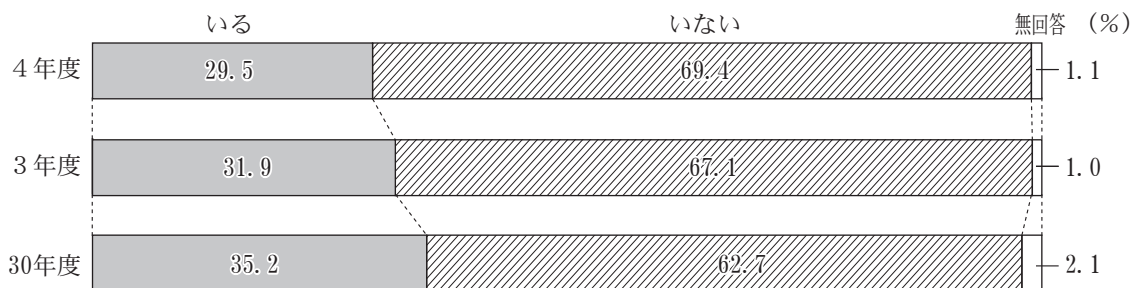

	R 4		R 3		H30	
	世帯数(世帯)	割合(%)	世帯数(世帯)	割合(%)	世帯数(世帯)	割合(%)
全体(世帯)	2,112		2,680		2,105	
1 と回答	623	29.5	855	31.9	742	35.2
2 と回答	1,465	69.4	1,797	67.1	1,319	62.7
無回答	24	1.1	28	1.0	44	2.1

13 受動喫煙の状況（調査票 問13の集計結果）

問13 あなたは、この1か月間に、自分以外の人が吸っていたたばこの煙を吸う機会（受動喫煙）がありましたか。（各場所につき、○は1つ）

- | | |
|-----------|-----------------|
| 1. ほぼ毎日 | 2. 週に数回程度 |
| 3. 週に1回程度 | 4. 月に1回程度 |
| 5. 全くなかった | 6. その場所へは行かなかった |

家庭

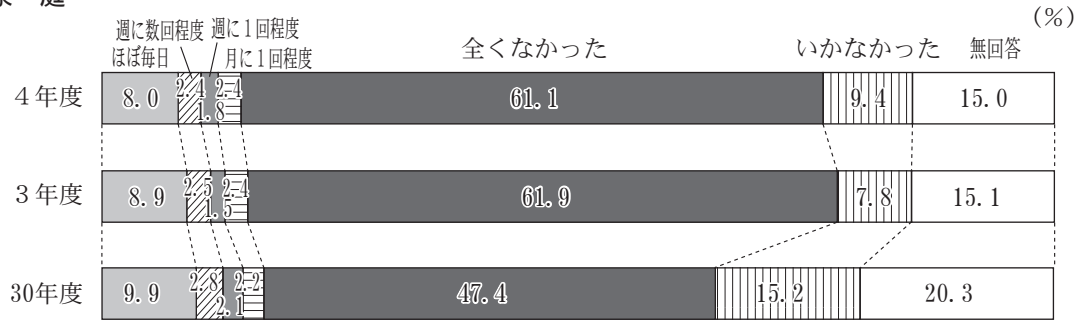

職場

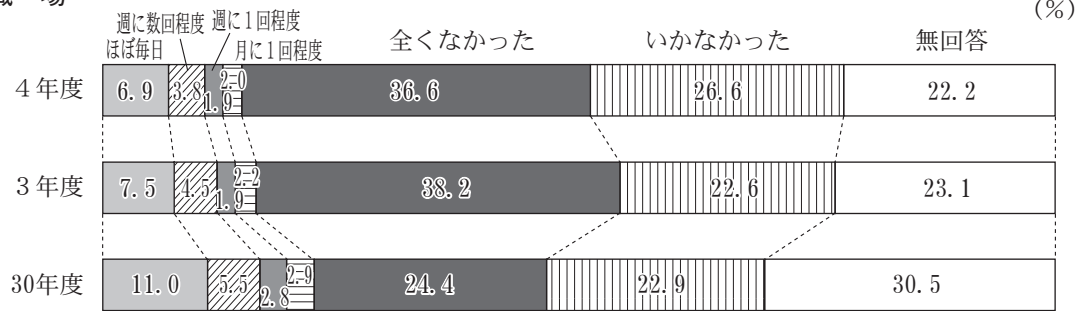

学校

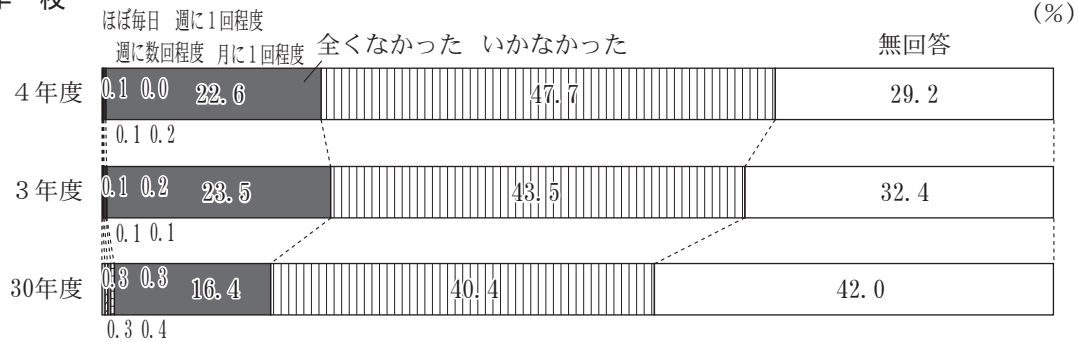

飲食店

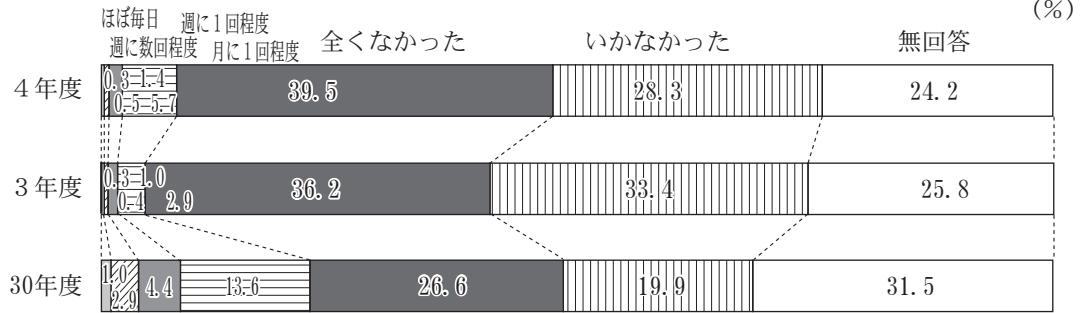

遊技場



行政機関

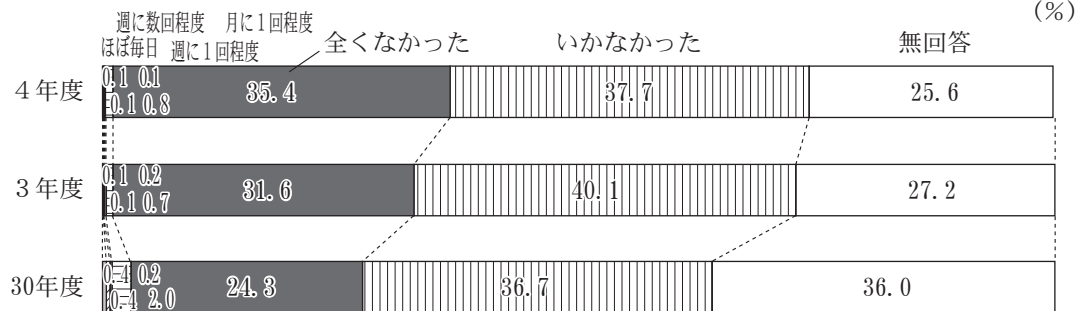

医療機関

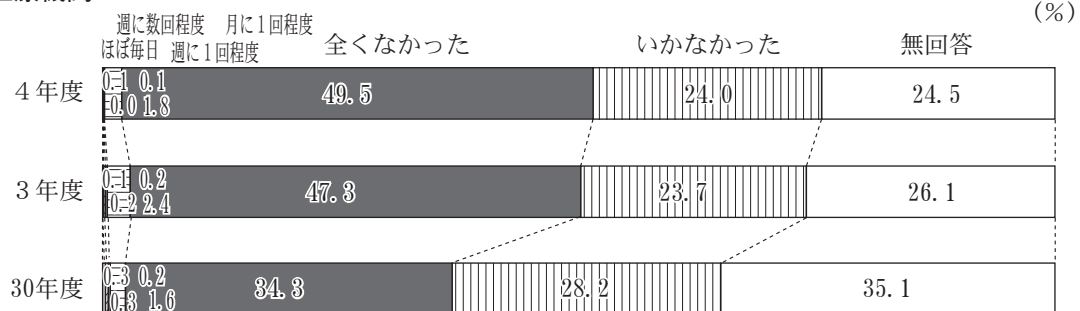

公共交通機関

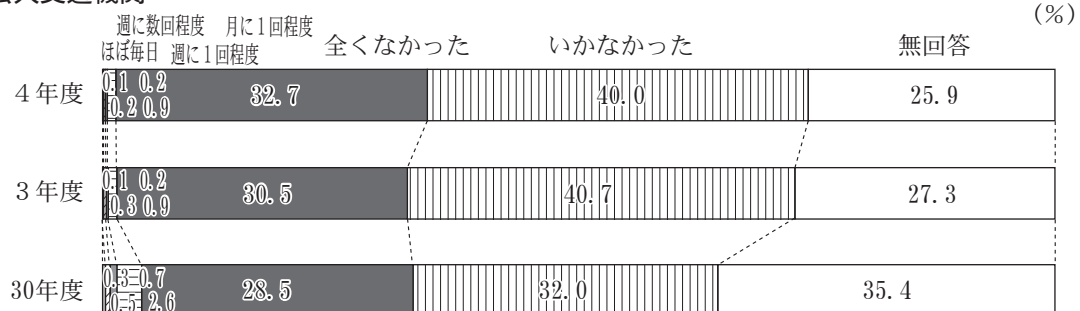

路上

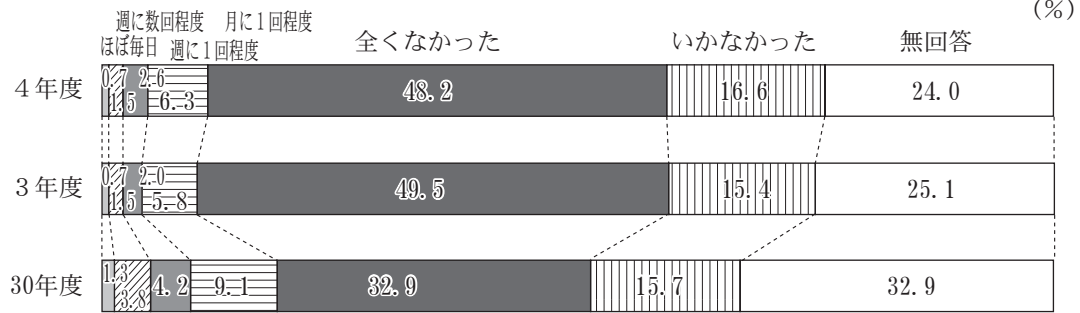

子供が利用する屋外の空間

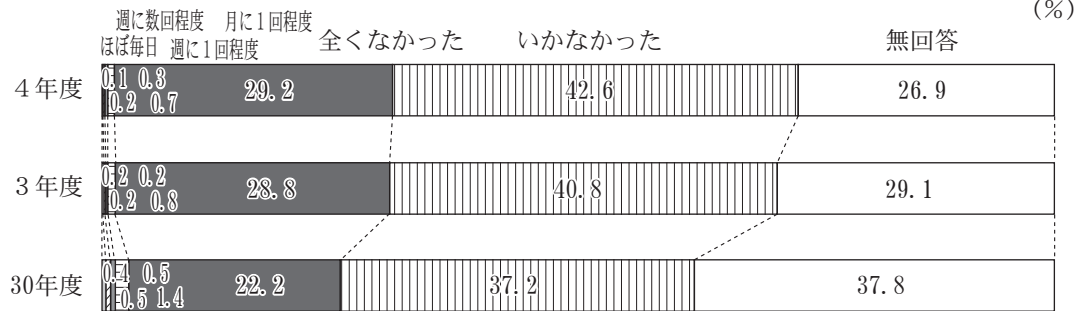

健康増進施設



○家 庭

	R 4		R 3		H30	
	人数(人)	割合(%)	人数(人)	割合(%)	人数(人)	割合(%)
1 と回答						
男 性	138	6.8	214	8.1	160	8.0
女 性	197	9.0	271	9.6	242	11.6
男女合計	335	8.0	485	8.9	402	9.9
2 と回答						
男 性	41	2.0	60	2.3	48	2.4
女 性	62	2.8	76	2.7	66	3.2
男女合計	103	2.4	136	2.5	114	2.8
3 と回答						
男 性	31	1.5	33	1.2	29	1.5
女 性	45	2.0	50	1.8	56	2.7
男女合計	76	1.8	83	1.5	85	2.1
4 と回答						
男 性	41	2.0	50	1.9	37	1.9
女 性	59	2.7	79	2.8	54	2.6
男女合計	100	2.4	129	2.4	91	2.2
5 と回答						
男 性	1,278	63.4	1,694	63.8	977	49.1
女 性	1,294	58.9	1,690	60.1	952	45.8
男女合計	2,572	61.1	3,384	61.9	1,929	47.4
6 と回答						
男 性	167	8.3	186	7.0	308	15.5
女 性	227	10.3	240	8.5	310	14.9
男女合計	394	9.4	426	7.8	618	15.2
無回答						
男 性	320	15.9	419	15.8	429	21.6
女 性	312	14.2	405	14.4	398	19.2
男女合計	632	15.0	824	15.1	827	20.3
全体(人)						
男 性	2,016		2,656		1,988	
女 性	2,196		2,811		2,078	
男女合計	4,212		5,467		4,066	

○職 場

	R 4		R 3		H30	
	人数(人)	割合(%)	人数(人)	割合(%)	人数(人)	割合(%)
1 と回答						
男 性	238	11.8	327	12.3	346	17.4
女 性	53	2.4	83	3.0	101	4.9
男女合計	291	6.9	410	7.5	447	11.0
2 と回答						
男 性	121	6.0	169	6.4	164	8.2
女 性	41	1.9	76	2.7	61	2.9
男女合計	162	3.8	245	4.5	225	5.5
3 と回答						
男 性	57	2.8	73	2.7	72	3.6
女 性	23	1.0	32	1.1	41	2.0
男女合計	80	1.9	105	1.9	113	2.8
4 と回答						
男 性	52	2.6	73	2.7	75	3.8
女 性	34	1.5	45	1.6	41	2.0
男女合計	86	2.0	118	2.2	116	2.9

	R 4		R 3		H30	
	人数(人)	割合(%)	人数(人)	割合(%)	人数(人)	割合(%)
5と回答						
男性	692	34.3	939	35.4	428	21.5
女性	849	38.7	1,150	40.9	565	27.2
男女合計	1,541	36.6	2,089	38.2	993	24.4
6と回答						
男性	441	21.9	525	19.8	370	18.6
女性	678	30.9	710	25.3	561	27.0
男女合計	1,119	26.6	1,235	22.6	931	22.9
無回答						
男性	415	20.6	550	20.7	533	26.8
女性	518	23.6	715	25.4	708	34.1
男女合計	933	22.2	1,265	23.1	1,241	30.5
全体(人)						
男性	2,016		2,656		1,988	
女性	2,196		2,811		2,078	
男女合計	4,212		5,467		4,066	

○学 校

	R 4		R 3		H30	
	人数(人)	割合(%)	人数(人)	割合(%)	人数(人)	割合(%)
1と回答						
男性	1	0.0	1	0.0	7	0.4
女性	2	0.1	2	0.1	5	0.2
男女合計	3	0.1	3	0.1	12	0.3
2と回答						
男性	1	0.0	6	0.2	6	0.3
女性	2	0.1	1	0.0	5	0.2
男女合計	3	0.1	7	0.1	11	0.3
3と回答						
男性	1	0.0	9	0.3	6	0.3
女性	0	0.0	2	0.1	5	0.2
男女合計	1	0.0	11	0.2	11	0.3
4と回答						
男性	5	0.2	5	0.2	7	0.4
女性	4	0.2	3	0.1	9	0.4
男女合計	9	0.2	8	0.1	16	0.4
5と回答						
男性	440	21.8	601	22.6	318	16.0
女性	513	23.4	686	24.4	349	16.8
男女合計	953	22.6	1,287	23.5	667	16.4
6と回答						
男性	950	47.1	1,170	44.1	799	40.2
女性	1,061	48.3	1,207	42.9	842	40.5
男女合計	2,011	47.7	2,377	43.5	1,641	40.4
無回答						
男性	618	30.7	864	32.5	845	42.5
女性	614	28.0	910	32.4	863	41.5
男女合計	1,232	29.2	1,774	32.4	1,708	42.0
全体(人)						
男性	2,016		2,656		1,988	
女性	2,196		2,811		2,078	
男女合計	4,212		5,467		4,066	

○飲食店

	R 4		R 3		H30	
	人数(人)	割合(%)	人数(人)	割合(%)	人数(人)	割合(%)
1 と回答						
男性	7	0.3	12	0.5	25	1.3
女性	4	0.2	5	0.2	17	0.8
男女合計	11	0.3	17	0.3	42	1.0
2 と回答						
男性	15	0.7	18	0.7	83	4.2
女性	8	0.4	5	0.2	36	1.7
男女合計	23	0.5	23	0.4	119	2.9
3 と回答						
男性	41	2.0	32	1.2	122	6.1
女性	20	0.9	25	0.9	57	2.7
男女合計	61	1.4	57	1.0	179	4.4
4 と回答						
男性	155	7.7	92	3.5	295	14.8
女性	84	3.8	65	2.3	257	12.4
男女合計	239	5.7	157	2.9	552	13.6
5 と回答						
男性	751	37.3	974	36.7	483	24.3
女性	913	41.6	1,003	35.7	599	28.8
男女合計	1,664	39.5	1,977	36.2	1,082	26.6
6 と回答						
男性	549	27.2	863	32.5	378	19.0
女性	644	29.3	963	34.3	433	20.8
男女合計	1,193	28.3	1,826	33.4	811	19.9
無回答						
男性	498	24.7	665	25.0	602	30.3
女性	523	23.8	745	26.5	679	32.7
男女合計	1,021	24.2	1,410	25.8	1,281	31.5
全体(人)						
男性	2,016		2,656		1,988	
女性	2,196		2,811		2,078	
男女合計	4,212		5,467		4,066	

○遊技場

	R 4		R 3		H30	
	人数(人)	割合(%)	人数(人)	割合(%)	人数(人)	割合(%)
1 と回答						
男性	8	0.4	13	0.5	31	1.6
女性	3	0.1	4	0.1	9	0.4
男女合計	11	0.3	17	0.3	40	1.0
2 と回答						
男性	22	1.1	34	1.3	78	3.9
女性	5	0.2	2	0.1	18	0.9
男女合計	27	0.6	36	0.7	96	2.4
3 と回答						
男性	29	1.4	42	1.6	94	4.7
女性	4	0.2	7	0.2	28	1.3
男女合計	33	0.8	49	0.9	122	3.0
4 と回答						
男性	46	2.3	42	1.6	102	5.1
女性	16	0.7	20	0.7	52	2.5
男女合計	62	1.5	62	1.1	154	3.8

	R 4		R 3		H30	
	人数(人)	割合(%)	人数(人)	割合(%)	人数(人)	割合(%)
5と回答						
男性	415	20.6	574	21.6	253	12.7
女性	456	20.8	568	20.2	294	14.1
男女合計	871	20.7	1,142	20.9	547	13.5
6と回答						
男性	968	48.0	1,248	47.0	764	38.4
女性	1,144	52.1	1,425	50.7	903	43.5
男女合計	2,112	50.1	2,673	48.9	1,667	41.0
無回答						
男性	528	26.2	703	26.5	666	33.5
女性	568	25.9	785	27.9	774	37.2
	1,096	26.0	1,488	27.2	1,440	35.4
全体(人)						
男性	2,016		2,656		1,988	
女性	2,196		2,811		2,078	
男女合計	4,212		5,467		4,066	

○行政機関

	R 4		R 3		H30	
	人数(人)	割合(%)	人数(人)	割合(%)	人数(人)	割合(%)
1と回答						
男性	3	0.1	1	0.0	10	0.5
女性	2	0.1	2	0.1	6	0.3
男女合計	5	0.1	3	0.1	16	0.4
2と回答						
男性	4	0.2	5	0.2	14	0.7
女性	1	0.0	0	0.0	1	0.0
男女合計	5	0.1	5	0.1	15	0.4
3と回答						
男性	3	0.1	6	0.2	5	0.3
女性	3	0.1	4	0.1	5	0.2
男女合計	6	0.1	10	0.2	10	0.2
4と回答						
男性	22	1.1	21	0.8	48	2.4
女性	13	0.6	20	0.7	34	1.6
男女合計	35	0.8	41	0.7	82	2.0
5と回答						
男性	716	35.5	870	32.8	487	24.5
女性	776	35.3	857	30.5	502	24.2
男女合計	1,492	35.4	1,727	31.6	989	24.3
6と回答						
男性	738	36.6	1,038	39.1	723	36.4
女性	851	38.8	1,156	41.1	768	37.0
男女合計	1,589	37.7	2,194	40.1	1,491	36.7
無回答						
男性	530	26.3	715	26.9	701	35.3
女性	550	25.0	772	27.5	762	36.7
男女合計	1,080	25.6	1,487	27.2	1,463	36.0
全体(人)						
男性	2,016		2,656		1,988	
女性	2,196		2,811		2,078	
男女合計	4,212		5,467		4,066	

○医療機関

	R 4		R 3		H30	
	人数(人)	割合(%)	人数(人)	割合(%)	人数(人)	割合(%)
1 と回答						
男性	2	0.1	3	0.1	9	0.5
女性	1	0.0	2	0.1	3	0.1
男女合計	3	0.1	5	0.1	12	0.3
2 と回答						
男性	1	0.0	5	0.2	9	0.5
女性	1	0.0	6	0.2	4	0.2
男女合計	2	0.0	11	0.2	13	0.3
3 と回答						
男性	1	0.0	6	0.2	3	0.2
女性	5	0.2	6	0.2	6	0.3
男女合計	6	0.1	12	0.2	9	0.2
4 と回答						
男性	34	1.7	76	2.9	43	2.2
女性	40	1.8	53	1.9	22	1.1
男女合計	74	1.8	129	2.4	65	1.6
5 と回答						
男性	962	47.7	1,230	46.3	650	32.7
女性	1,124	51.2	1,357	48.3	746	35.9
男女合計	2,086	49.5	2,587	47.3	1,396	34.3
6 と回答						
男性	504	25.0	648	24.4	580	29.2
女性	507	23.1	649	23.1	565	27.2
男女合計	1,011	24.0	1,297	23.7	1,145	28.2
無回答						
男性	512	25.4	688	25.9	694	34.9
女性	518	23.6	738	26.3	732	35.2
男女合計	1,030	24.5	1,426	26.1	1,426	35.1
全体(人)						
男性	2,016		2,656		1,988	
女性	2,196		2,811		2,078	
男女合計	4,212		5,467		4,066	

○公共交通機関

	R 4		R 3		H30	
	人数(人)	割合(%)	人数(人)	割合(%)	人数(人)	割合(%)
1 と回答						
男性	1	0.0	3	0.1	11	0.6
女性	4	0.2	2	0.1	3	0.1
男女合計	5	0.1	5	0.1	14	0.3
2 と回答						
男性	4	0.2	11	0.4	13	0.7
女性	3	0.1	3	0.1	6	0.3
男女合計	7	0.2	14	0.3	19	0.5
3 と回答						
男性	5	0.2	5	0.2	18	0.9
女性	5	0.2	7	0.2	9	0.4
男女合計	10	0.2	12	0.2	27	0.7
4 と回答						
男性	18	0.9	24	0.9	66	3.3
女性	18	0.8	26	0.9	40	1.9
男女合計	36	0.9	50	0.9	106	2.6

	R 4		R 3		H30	
	人数(人)	割合(%)	人数(人)	割合(%)	人数(人)	割合(%)
5と回答						
男性	652	32.3	829	31.2	557	28.0
女性	726	33.1	839	29.8	602	29.0
男女合計	1,378	32.7	1,668	30.5	1,159	28.5
6と回答						
男性	793	39.3	1,064	40.1	637	32.0
女性	892	40.6	1,161	41.3	664	32.0
男女合計	1,685	40.0	2,225	40.7	1,301	32.0
無回答						
男性	543	26.9	720	27.1	686	34.5
女性	548	25.0	773	27.5	754	36.3
男女合計	1,091	25.9	1,493	27.3	1,440	35.4
全体(人)						
男性	2,016		2,656		1,988	
女性	2,196		2,811		2,078	
男女合計	4,212		5,467		4,066	

○路 上

	R 4		R 3		H30	
	人数(人)	割合(%)	人数(人)	割合(%)	人数(人)	割合(%)
1と回答						
男性	16	0.8	23	0.9	28	1.4
女性	15	0.7	17	0.6	25	1.2
男女合計	31	0.7	40	0.7	53	1.3
2と回答						
男性	36	1.8	54	2.0	89	4.5
女性	28	1.3	30	1.1	66	3.2
男女合計	64	1.5	84	1.5	155	3.8
3と回答						
男性	57	2.8	64	2.4	100	5.0
女性	52	2.4	45	1.6	71	3.4
男女合計	109	2.6	109	2.0	171	4.2
4と回答						
男性	122	6.1	144	5.4	188	9.5
女性	144	6.6	171	6.1	184	8.9
男女合計	266	6.3	315	5.8	372	9.1
5と回答						
男性	992	49.2	1,334	50.2	647	32.5
女性	1,038	47.3	1,370	48.7	692	33.3
男女合計	2,030	48.2	2,704	49.5	1,339	32.9
6と回答						
男性	302	15.0	385	14.5	298	15.0
女性	399	18.2	459	16.3	342	16.5
男女合計	701	16.6	844	15.4	640	15.7
無回答						
男性	491	24.4	652	24.5	638	32.1
女性	520	23.7	719	25.6	698	33.6
男女合計	1,011	24.0	1,371	25.1	1,336	32.9
全体(人)						
男性	2,016		2,656		1,988	
女性	2,196		2,811		2,078	
男女合計	4,212		5,467		4,066	

○子供が利用する屋外の空間

	R 4		R 3		H30	
	人数(人)	割合(%)	人数(人)	割合(%)	人数(人)	割合(%)
1 と回答						
男性	3	0.1	7	0.3	7	0.4
女性	1	0.0	3	0.1	8	0.4
男女合計	4	0.1	10	0.2	15	0.4
2 と回答						
男性	4	0.2	7	0.3	14	0.7
女性	4	0.2	3	0.1	5	0.2
男女合計	8	0.2	10	0.2	19	0.5
3 と回答						
男性	6	0.3	5	0.2	12	0.6
女性	8	0.4	8	0.3	10	0.5
男女合計	14	0.3	13	0.2	22	0.5
4 と回答						
男性	16	0.8	22	0.8	28	1.4
女性	13	0.6	20	0.7	30	1.4
男女合計	29	0.7	42	0.8	58	1.4
5 と回答						
男性	594	29.5	789	29.7	447	22.5
女性	638	29.1	785	27.9	457	22.0
男女合計	1,232	29.2	1,574	28.8	904	22.2
6 と回答						
男性	841	41.7	1,063	40.0	745	37.5
女性	953	43.4	1,165	41.4	767	36.9
男女合計	1,794	42.6	2,228	40.8	1,512	37.2
無回答						
男性	552	27.4	763	28.7	735	37.0
女性	579	26.4	827	29.4	801	38.5
男女合計	1,131	26.9	1,590	29.1	1,536	37.8
全体(人)						
男性	2,016		2,656		1,988	
女性	2,196		2,811		2,078	
男女合計	4,212		5,467		4,066	

○健康増進施設

	R 4		R 3		H30	
	人数(人)	割合(%)	人数(人)	割合(%)	人数(人)	割合(%)
1 と回答						
男性	1	0.0	3	0.1	3	0.2
女性	2	0.1	0	0.0	3	0.1
男女合計	3	0.1	3	0.1	6	0.1
2 と回答						
男性	3	0.1	7	0.3	5	0.3
女性	3	0.1	3	0.1	3	0.1
男女合計	6	0.1	10	0.2	8	0.2
3 と回答						
男性	1	0.0	11	0.4	11	0.6
女性	4	0.2	2	0.1	3	0.1
男女合計	5	0.1	13	0.2	14	0.3
4 と回答						
男性	2	0.1	8	0.3	18	0.9
女性	3	0.1	7	0.2	7	0.3
男女合計	5	0.1	15	0.3	25	0.6

	R 4		R 3		H30	
	人数(人)	割合(%)	人数(人)	割合(%)	人数(人)	割合(%)
5と回答						
男性	484	24.0	647	24.4	380	19.1
女性	534	24.3	685	24.4	402	19.3
男女合計	1,018	24.2	1,332	24.4	782	19.2
6と回答						
男性	964	47.8	1,200	45.2	820	41.2
女性	1,064	48.5	1,280	45.5	852	41.0
男女合計	2,028	48.1	2,480	45.4	1,672	41.1
無回答						
男性	561	27.8	780	29.4	751	37.8
女性	586	26.7	834	29.7	808	38.9
男女合計	1,147	27.2	1,614	29.5	1,559	38.3
全体(人)						
男性	2,016		2,656		1,988	
女性	2,196		2,811		2,078	
男女合計	4,212		5,467		4,066	

14 「COPD（慢性閉塞性肺疾患）」の認知度（調査票 問14の集計結果）

問14 あなたは、「COPD（慢性閉塞性肺疾患）」という病気を知っていますか。

1 知っている	2 知らない
---------	--------

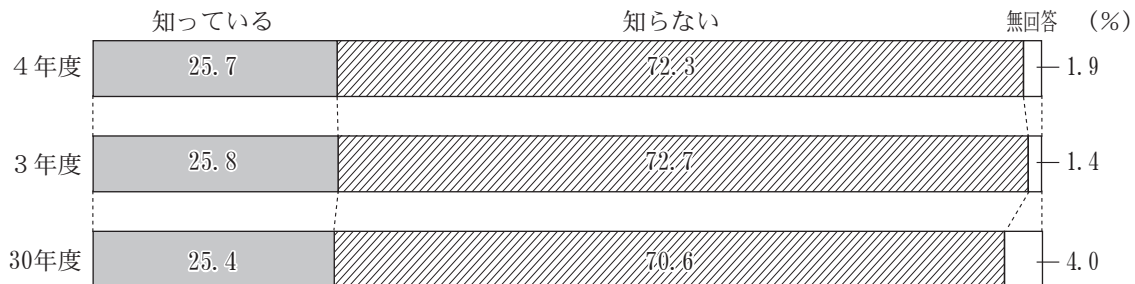

	R 4		R 3		H30	
	人数(人)	割合(%)	人数(人)	割合(%)	人数(人)	割合(%)
1と回答						
男性	446	22.1	564	21.2	418	21.0
女性	638	29.1	847	30.1	613	29.5
男女合計	1,084	25.7	1,411	25.8	1,031	25.4
2と回答						
男性	1,538	76.3	2,067	77.8	1,500	75.5
女性	1,509	68.7	1,910	67.9	1,372	66.0
男女合計	3,047	72.3	3,977	72.7	2,872	70.6
無回答						
男性	32	1.6	25	0.9	70	3.5
女性	49	2.2	54	1.9	93	4.5
男女合計	81	1.9	79	1.4	163	4.0
全体(人)						
男性	2,016		2,656		1,988	
女性	2,196		2,811		2,078	
男女合計	4,212		5,467		4,066	

15 飲酒の状況（満20歳以上対象）（調査票 問15の集計結果）

(1) 飲酒の頻度

問15 あなたは、どのくらいお酒を飲んでいますか。（あてはまる番号1つに○）

20歳以上の方のみお答えください。

- | | |
|------------------------|--------------------|
| 1 毎日飲んでいる（付問へ） | 2 週に5～6回飲んでいる（付問へ） |
| 3 週に3～4回飲んでいる（付問へ） | 4 たまに飲む程度（付問へ） |
| 5 以前は飲んでいましたが、今は飲んでいない | 6 もともと飲まない |

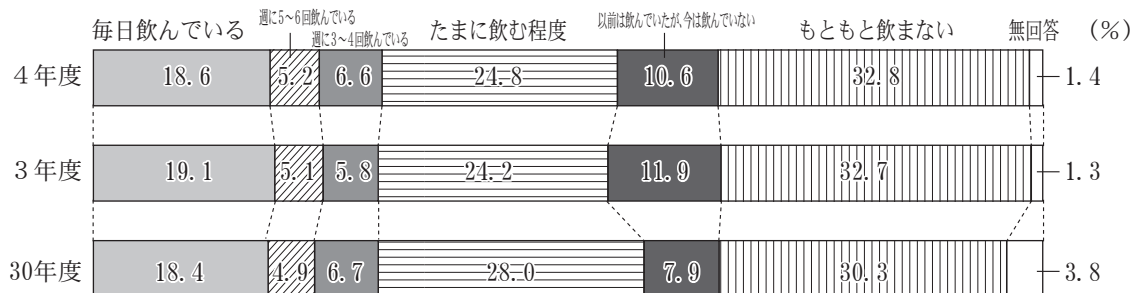

	R 4		R 3		H30	
	人数(人)	割合(%)	人数(人)	割合(%)	人数(人)	割合(%)
1と回答						
男性	587	30.4	783	30.9	581	30.4
女性	166	7.8	214	8.0	140	7.0
男女合計	753	18.6	997	19.1	721	18.4
2と回答						
男性	144	7.4	188	7.4	142	7.4
女性	68	3.2	76	2.8	49	2.4
男女合計	212	5.2	264	5.1	191	4.9
3と回答						
男性	159	8.2	191	7.5	178	9.3
女性	108	5.1	110	4.1	86	4.3
男女合計	267	6.6	301	5.8	264	6.7
4と回答						
男性	437	22.6	558	22.0	499	26.1
女性	570	26.9	705	26.2	600	29.9
男女合計	1,007	24.8	1,263	24.2	1,099	28.0
5と回答						
男性	219	11.3	317	12.5	168	8.8
女性	211	9.9	304	11.3	142	7.1
男女合計	430	10.6	621	11.9	310	7.9
6と回答						
男性	371	19.2	476	18.8	284	14.9
女性	960	45.2	1,232	45.9	903	44.9
男女合計	1,331	32.8	1,708	32.7	1,187	30.3
無回答						
男性	17	0.9	24	0.9	60	3.1
女性	39	1.8	46	1.7	90	4.5
男女合計	56	1.4	70	1.3	150	3.8
全体(人)						
男性	1,934		2,537		1,912	
女性	2,122		2,687		2,010	
男女合計	4,056		5,224		3,922	

(2) 飲酒の量 (調査票 問15付問の集計結果)

付問 問15で1～4を選んだ方におたずねします。あなたが1回に飲む量はどれくらいですか。日本酒にあてはめて計算し、あてはまる番号を1つ選んで○をつけてください。(計算の仕方は、下記のとおりです。)

1 極少量	2 1合程度
3 2合程度	4 3合以上

日本酒1合あたりのアルコール量は以下と同等

- ・焼酎 (25度、100ml)
- ・ビール中瓶1本 (500ml)
- ・ウィスキーダブル1杯 (60ml)
- ・ワイングラス2杯 (200ml)

うすめて飲むときは、もとの量で計算してください。

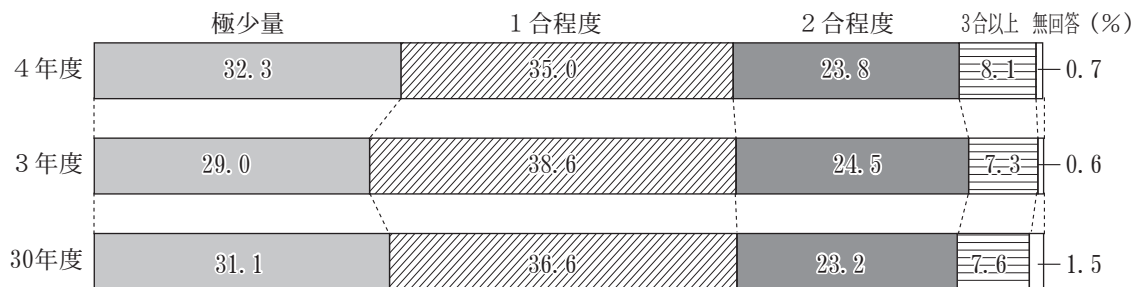

	R 4		R 3		H30	
	人数(人)	割合(%)	人数(人)	割合(%)	人数(人)	割合(%)
1と回答						
男性	238	17.9	287	16.7	257	18.4
女性	486	53.3	532	48.1	450	51.4
男女合計	724	32.3	819	29.0	707	31.1
2と回答						
男性	491	37.0	673	39.1	541	38.6
女性	292	32.0	417	37.7	292	33.4
男女合計	783	35.0	1,090	38.6	833	36.6
3と回答						
男性	433	32.6	572	33.3	437	31.2
女性	101	11.1	121	11.0	91	10.4
男女合計	534	23.8	693	24.5	528	23.2
4と回答						
男性	156	11.8	180	10.5	152	10.9
女性	26	2.9	26	2.4	22	2.5
男女合計	182	8.1	206	7.3	174	7.6
無回答						
男性	9	0.7	8	0.5	13	0.9
女性	7	0.8	9	0.8	20	2.3
男女合計	16	0.7	17	0.6	33	1.5
全体(人)						
男性	1,327		1,720		1,400	
女性	912		1,105		875	
男女合計	2,239		2,825		2,275	

16 定期的な歯科健診の状況（調査票 問16の集計結果）

問16 あなたは、定期的に歯科健診（歯石の除去、歯面清掃を含む）を受けていますか。

1 はい	2 いいえ
------	-------

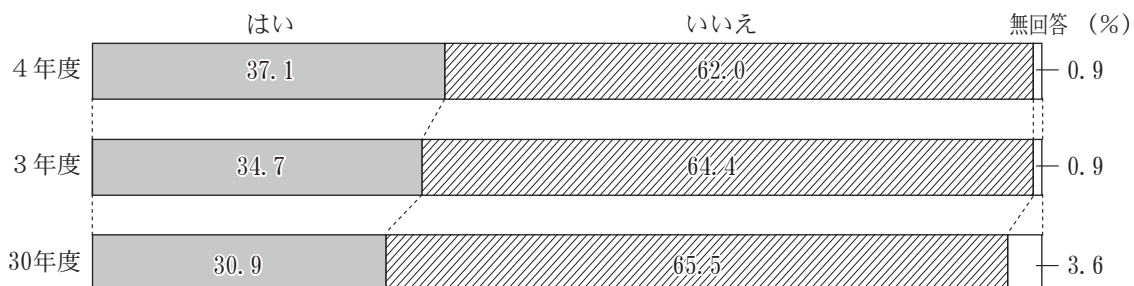

	R 4		R 3		H30	
	人数(人)	割合(%)	人数(人)	割合(%)	人数(人)	割合(%)
1 と回答						
男性	641	31.8	786	29.6	526	26.5
女性	921	41.9	1,110	39.5	729	35.1
男女合計	1,562	37.1	1,896	34.7	1,255	30.9
2 と回答						
男性	1,359	67.4	1,849	69.6	1,395	70.2
女性	1,251	57.0	1,673	59.5	1,270	61.1
男女合計	2,610	62.0	3,522	64.4	2,665	65.5
無回答						
男性	16	0.8	21	0.8	67	3.4
女性	24	1.1	28	1.0	79	3.8
男女合計	40	0.9	49	0.9	146	3.6
全体(人)						
男性	2,016		2,656		1,988	
女性	2,196		2,811		2,078	
男女合計	4,212		5,467		4,066	

17 歯みがきの状況（調査票 問17の集計結果）

問17 あなたは、毎食後（1日3回以上）歯をみがいていますか。

1 はい	2 いいえ
------	-------

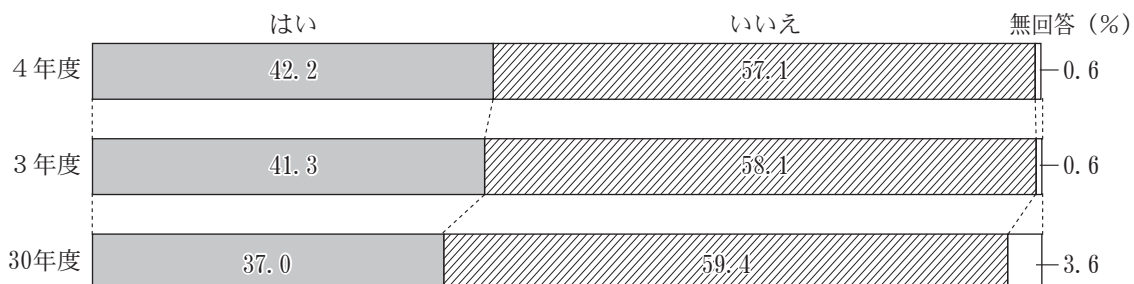

	R 4		R 3		H30	
	人数(人)	割合(%)	人数(人)	割合(%)	人数(人)	割合(%)
1 と回答						
男性	701	34.8	882	33.2	564	28.4
女性	1,078	49.1	1,378	49.0	941	45.3
男女合計	1,779	42.2	2,260	41.3	1,505	37.0
2 と回答						
男性	1,302	64.6	1,759	66.2	1,353	68.1
女性	1,105	50.3	1,416	50.4	1,061	51.1
男女合計	2,407	57.1	3,175	58.1	2,414	59.4
無回答						
男性	13	0.6	15	0.6	71	3.6
女性	13	0.6	17	0.6	76	3.7
男女合計	26	0.6	32	0.6	147	3.6
全体(人)						
男性	2,016		2,656		1,988	
女性	2,196		2,811		2,078	
男女合計	4,212		5,467		4,066	

18 外出の状況 (調査票 問18の集計結果)

問18 あなたは、積極的に外出するほうですか。

(外出には日常生活の中での買物や散歩を含めます)

1 はい	2 いいえ
------	-------

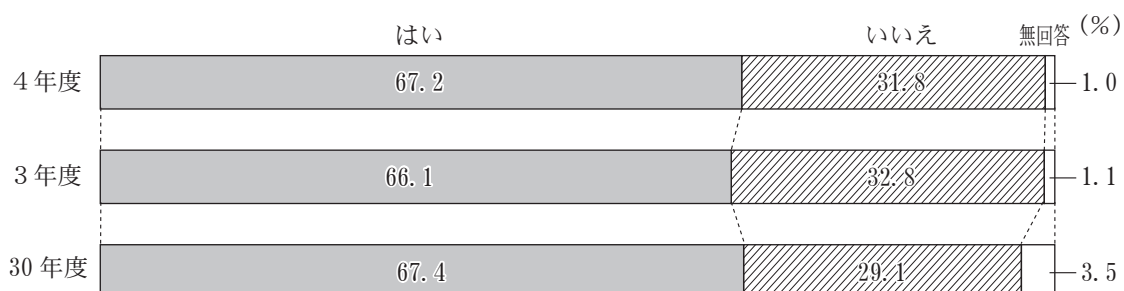

	R 4		R 3		H30	
	人数(人)	割合(%)	人数(人)	割合(%)	人数(人)	割合(%)
1 と回答						
男性	1,317	65.3	1,733	65.2	1,327	66.8
女性	1,512	68.9	1,878	66.8	1,415	68.1
男女合計	2,829	67.2	3,611	66.1	2,742	67.4
2 と回答						
男性	677	33.6	894	33.7	589	29.6
女性	662	30.1	900	32.0	594	28.6
男女合計	1,339	31.8	1,794	32.8	1,183	29.1
無回答						
男性	22	1.1	29	1.1	72	3.6
女性	22	1.0	33	1.2	69	3.3
男女合計	44	1.0	62	1.1	141	3.5
全体(人)						
男性	2,016		2,656		1,988	
女性	2,196		2,811		2,078	
男女合計	4,212		5,467		4,066	

*60歳以上

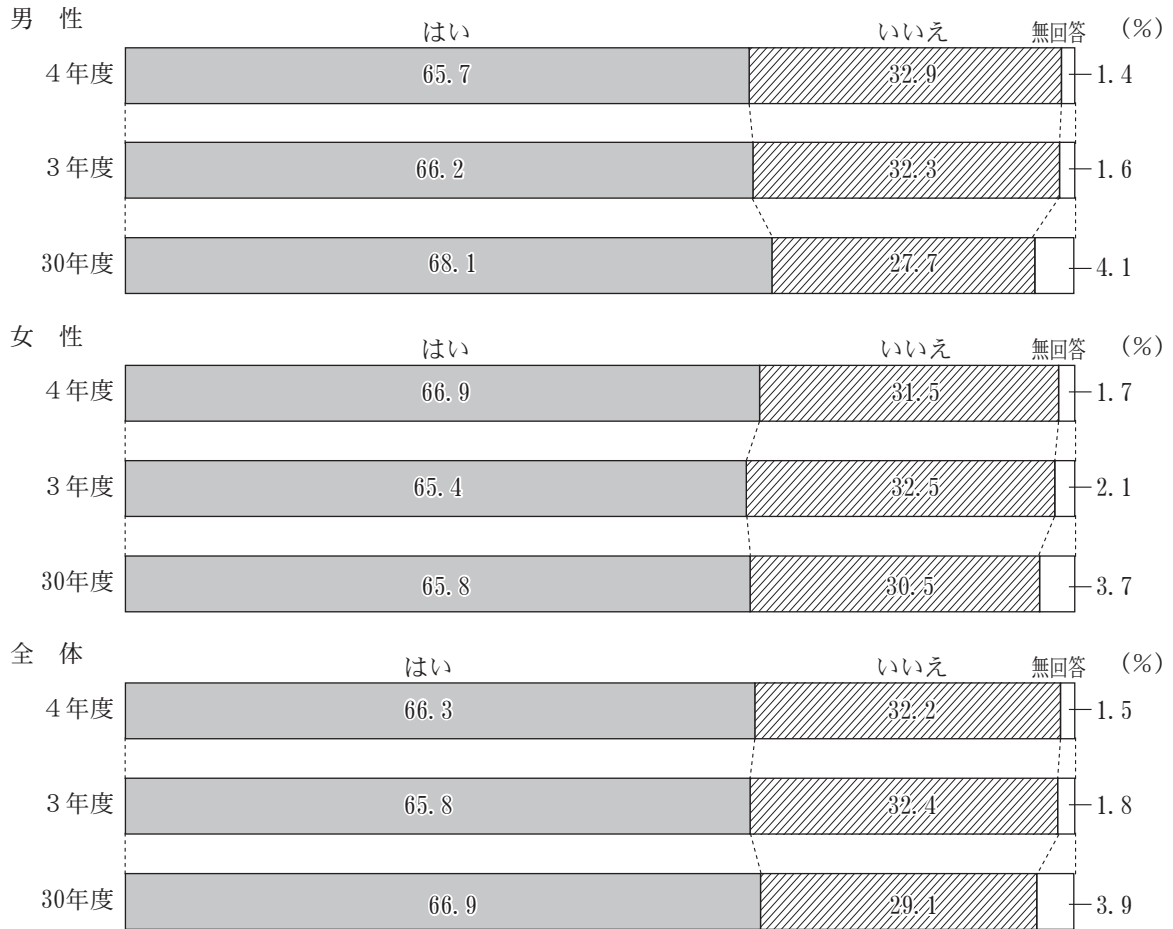

	R 4		R 3		H30	
	人数(人)	割合(%)	人数(人)	割合(%)	人数(人)	割合(%)
1と回答						
男性	702	65.7	896	66.2	723	68.1
女性	805	66.9	969	65.4	742	65.8
男女合計	1,507	66.3	1,865	65.8	1,465	66.9
2と回答						
男性	352	32.9	437	32.3	294	27.7
女性	379	31.5	481	32.5	344	30.5
男女合計	731	32.2	918	32.4	638	29.1
無回答						
男性	15	1.4	21	1.6	44	4.1
女性	20	1.7	31	2.1	42	3.7
男女合計	35	1.5	52	1.8	86	3.9
全体(人)						
男性	1,069		1,354		1,061	
女性	1,204		1,481		1,128	
男女合計	2,273		2,835		2,189	

	R 4		R 3		H30	
	人数(人)	割合(%)	人数(人)	割合(%)	人数(人)	割合(%)
1 と回答						
男性	58	2.9	106	4.0	96	4.8
女性	69	3.1	112	4.0	108	5.2
男女合計	127	3.0	218	4.0	204	5.0
2 と回答						
男性	204	10.1	273	10.3	249	12.5
女性	251	11.4	299	10.6	272	13.1
男女合計	455	10.8	572	10.5	521	12.8
3 と回答						
男性	204	10.1	244	9.2	274	13.8
女性	281	12.8	331	11.8	348	16.7
男女合計	485	11.5	575	10.5	622	15.3
4 と回答						
男性	96	4.8	125	4.7	137	6.9
女性	87	4.0	111	3.9	101	4.9
男女合計	183	4.3	236	4.3	238	5.9
5 と回答						
男性	343	17.0	452	17.0	406	20.4
女性	199	9.1	240	8.5	225	10.8
男女合計	542	12.9	692	12.7	631	15.5
6 と回答						
男性	25	1.2	36	1.4	32	1.6
女性	44	2.0	43	1.5	51	2.5
男女合計	69	1.6	79	1.4	83	2.0
7 と回答						
男性	37	1.8	57	2.1	61	3.1
女性	22	1.0	33	1.2	33	1.6
男女合計	59	1.4	90	1.6	94	2.3
8 と回答						
男性	47	2.3	44	1.7	64	3.2
女性	37	1.7	52	1.8	69	3.3
男女合計	84	2.0	96	1.8	133	3.3
9 と回答						
男性	1,205	59.8	1,615	60.8	1,018	51.2
女性	1,415	64.4	1,873	66.6	1,132	54.5
	2,620	62.2	3,488	63.8	2,150	52.9
全体(人)						
男性	2,016		2,656		1,988	
女性	2,196		2,811		2,078	
男女合計	4,212		5,467		4,066	

20 睡眠時間の状況（調査票 問20の集計結果）

問20 あなたのふだんの睡眠時間は、どのくらいですか。

（あてはまる番号1つに○）

1	4時間以下	2	5時間位	3	6時間位
4	7時間位	5	8時間位	6	9時間以上

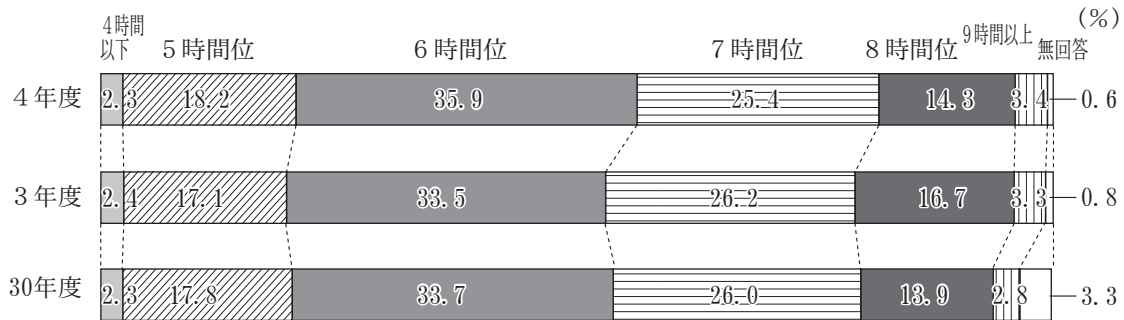

	R 4		R 3		H30	
	人数(人)	割合(%)	人数(人)	割合(%)	人数(人)	割合(%)
1と回答						
男性	48	2.4	53	2.0	37	1.9
女性	49	2.2	76	2.7	58	2.8
男女合計	97	2.3	129	2.4	95	2.3
2と回答						
男性	321	15.9	404	15.2	344	17.3
女性	444	20.2	533	19.0	379	18.2
男女合計	765	18.2	937	17.1	723	17.8
3と回答						
男性	683	33.9	882	33.2	665	33.5
女性	830	37.8	947	33.7	707	34.0
男女合計	1,513	35.9	1,829	33.5	1,372	33.7
4と回答						
男性	555	27.5	713	26.8	513	25.8
女性	514	23.4	722	25.7	545	26.2
男女合計	1,069	25.4	1,435	26.2	1,058	26.0
5と回答						
男性	316	15.7	485	18.3	306	15.4
女性	285	13.0	430	15.3	261	12.6
男女合計	601	14.3	915	16.7	567	13.9
6と回答						
男性	81	4.0	101	3.8	56	2.8
女性	61	2.8	78	2.8	59	2.8
男女合計	142	3.4	179	3.3	115	2.8
無回答						
男性	12	0.6	18	0.7	67	3.4
女性	13	0.6	25	0.9	69	3.3
男女合計	25	0.6	43	0.8	136	3.3
全体(人)						
男性	2,016		2,656		1,988	
女性	2,196		2,811		2,078	
男女合計	4,212		5,467		4,066	

*40～69歳

1 6時間以下	2 7時間以上
---------	---------

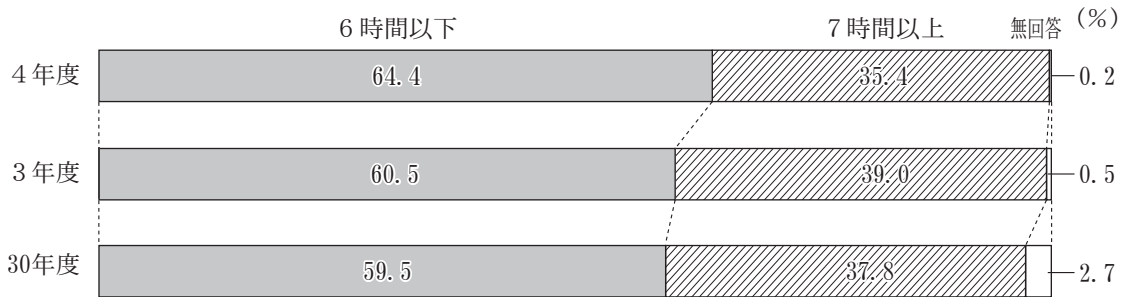

	R 4		R 3		H30	
	人数(人)	割合(%)	人数(人)	割合(%)	人数(人)	割合(%)
1と回答						
男性	566	59.1	753	57.3	543	56.2
女性	720	69.3	857	63.6	654	62.6
男女合計	1,286	64.4	1,610	60.5	1,197	59.5
2と回答						
男性	388	40.5	553	42.1	398	41.2
女性	318	30.6	486	36.1	362	34.6
男女合計	706	35.4	1,039	39.0	760	37.8
無回答						
男性	3	0.3	8	0.6	26	2.7
女性	1	0.1	4	0.3	29	2.8
男女合計	4	0.2	12	0.5	55	2.7
全体(人)						
男性	957		1,314		967	
女性	1,039		1,347		1,045	
男女合計	1,996		2,661		2,012	

21 睡眠による休養の状況 (調査票 問21の集計結果)

問21 ここ1ヶ月間、あなたは睡眠で休養が十分とれていますか。

(あてはまる番号1つに○)

1 十分とれている	2 まあまあとれている
3 あまりとれていない	4 まったくとれていない

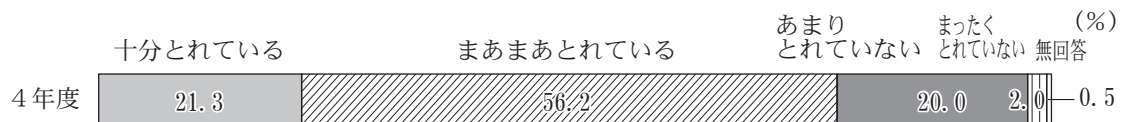

	R 4	
	人数(人)	割合(%)
1と回答		
男性	471	23.4
女性	426	19.4
男女合計	897	21.3
2と回答		
男性	1,100	54.6
女性	1,266	57.7
男女合計	2,366	56.2
3と回答		
男性	402	19.9
女性	439	20.0
男女合計	841	20.0
4と回答		
男性	34	1.7
女性	52	2.4
男女合計	86	2.0
無回答		
男性	9	0.4
女性	13	0.6
男女合計	22	0.5
全体(人)		
男性	2,016	
女性	2,196	
男女合計	4,212	

22 疲労の状況（調査票 問22の集計結果）

問22 あなたは、疲れすぎた*と感じていますか。（あてはまる番号1つに○）

1 感じている	2 あまり感じていない
3 まったく感じていない	

*日常感じる疲れから一歩進んで、疲れが抜けられないような状態

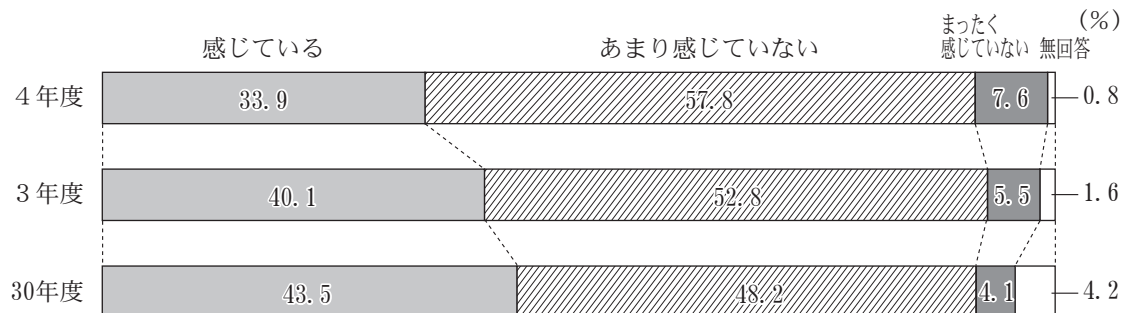

	R 4		R 3		H30	
	人数(人)	割合(%)	人数(人)	割合(%)	人数(人)	割合(%)
1 と回答						
男性	644	31.9	984	37.0	827	41.6
女性	783	35.7	1,207	42.9	943	45.4
男女合計	1,427	33.9	2,191	40.1	1,770	43.5
2 と回答						
男性	1,195	59.3	1,485	55.9	981	49.3
女性	1,238	56.4	1,403	49.9	978	47.1
男女合計	2,433	57.8	2,888	52.8	1,959	48.2
3 と回答						
男性	165	8.2	156	5.9	101	5.1
女性	154	7.0	144	5.1	67	3.2
男女合計	319	7.6	300	5.5	168	4.1
無回答						
男性	12	0.6	31	1.2	79	4.0
女性	21	1.0	57	2.0	90	4.3
男女合計	33	0.8	88	1.6	169	4.2
全体(人)						
男性	2,016		2,656		1,988	
女性	2,196		2,811		2,078	
男女合計	4,212		5,467		4,066	

*40~69歳

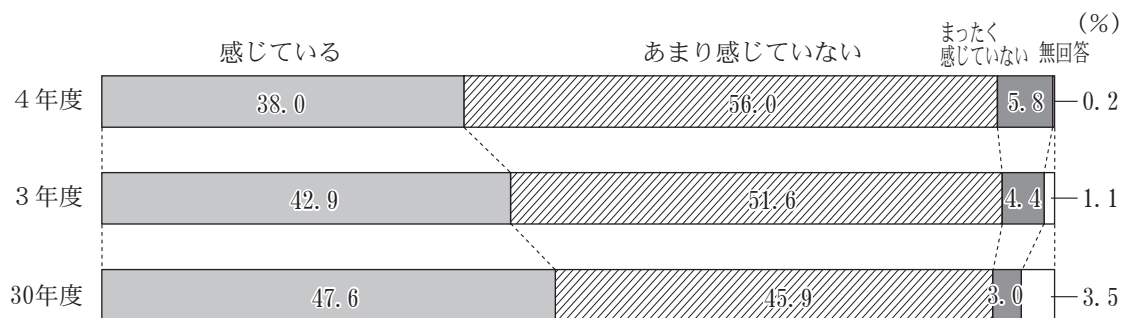

	R 4		R 3		H30	
	人数(人)	割合(%)	人数(人)	割合(%)	人数(人)	割合(%)
1 と回答						
男性	349	36.5	525	40.0	449	46.4
女性	409	39.4	616	45.7	509	48.7
男女合計	758	38.0	1,141	42.9	958	47.6
2 と回答						
男性	547	57.2	714	54.3	448	46.3
女性	571	55.0	660	49.0	475	45.5
男女合計	1,118	56.0	1,374	51.6	923	45.9
3 と回答						
男性	59	6.2	65	4.9	34	3.5
女性	57	5.5	53	3.9	27	2.6
男女合計	116	5.8	118	4.4	61	3.0
無回答						
男性	2	0.2	10	0.8	36	3.7
女性	2	0.2	18	1.3	34	3.3
男女合計	4	0.2	28	1.1	70	3.5
全体(人)						
男性	957		1,314		967	
女性	1,039		1,347		1,045	
男女合計	1,996		2,661		2,012	

第4章 原子力被災12市町村の調査結果の推移

1 調査客体

○ 令和4年度健康ふくしま21調査（田村市、南相馬市、川俣町、広野町、楡葉町）

(1) 調査世帯数

	対象世帯数	回答世帯数	回答率
総数	479	119	24.8%

(2) 調査者数

	対象者数	回答者数	回答率	回答者男女別	
				男	女
総数	1,045	205	19.6%	103	102

(3) 回答者年齢階級別状況

年齢階級	総数	男	女
15～19歳	6	2	4
20～29歳	9	4	5
30～39歳	17	10	7
40～49歳	22	8	14
50～59歳	39	18	21
60～64歳	21	14	7
65～69歳	24	15	9
70～79歳	43	25	18
80～89歳	17	4	13
90歳～	7	3	4
合計	205	103	102

○ 令和3年度健康ふくしま21調査（南相馬市、川内村、浪江町、大熊町）

(1) 調査世帯数

	対象世帯数	回答世帯数	回答率
総数	319	111	34.8%

(2) 調査者数

	対象者数	回答者数	回答率	回答者男女別	
				男	女
総数	829	267	32.2%	134	133

(3) 回答者年齢階級別状況

年齢階級	総数	男	女
15～19歳	8	2	6
20～29歳	8	2	6
30～39歳	9	4	5
40～49歳	13	4	9
50～59歳	22	8	14
60～64歳	36	19	17
65～69歳	44	26	18
70～79歳	79	45	34
80～89歳	40	21	19
90歳～	8	3	5
合計	267	134	133

○ 平成30年度健康ふくしま21調査（田村市、南相馬市、川俣町、広野町、富岡町、大熊町、浪江町）

(1) 調査世帯数

	対象世帯数	回答世帯数	回答率
総数	387	155	40.1%

(2) 調査者数

	対象者数	回答者数	回答率	回答者男女別	
				男	女
総数	974	293	30.1%	138	155

(3) 回答者年齢階級別状況

年齢階級	総数	男	女
15～19歳	2	2	0
20～29歳	15	8	7
30～39歳	16	9	7
40～49歳	22	12	10
50～59歳	40	13	27
60～64歳	32	14	18
65～69歳	57	31	26
70～79歳	62	29	33
80～89歳	39	19	20
90歳～	8	1	7
合計	293	138	155

○ 平成21年度県民健康調査（田村市、南相馬市、富岡町、浪江町、葛尾村）

(1) 調査世帯数

	対象世帯数	回答世帯数	回答率
総 数	487	258	53.0%

(2) 調査者数

	対象者数	回答者数	回答率	回答者男女別	
				男	女
総 数	1,269	613	48.3%	303	310

(3) 回答者年齢階級別状況

年齢階級	総 数	男	女
15～19歳	29	17	12
20～29歳	51	30	21
30～39歳	64	33	31
40～49歳	44	13	31
50～59歳	133	67	66
60～64歳	79	43	36
65～69歳	57	28	29
70～79歳	103	54	49
80～89歳	48	15	33
90歳～	5	3	2
合 計	613	303	310

2 最近1年間の運動状況

(1) 運動の状況

問10 最近1年間の運動について、あてはまるものを1つ選んで○をつけてください。

- 1 何らかの運動をほとんど毎日している。
- 2 何らかの運動を週2～4回程度している。
- 3 何らかの運動を週1回程度している。
- 4 ほとんど（まったく）していない

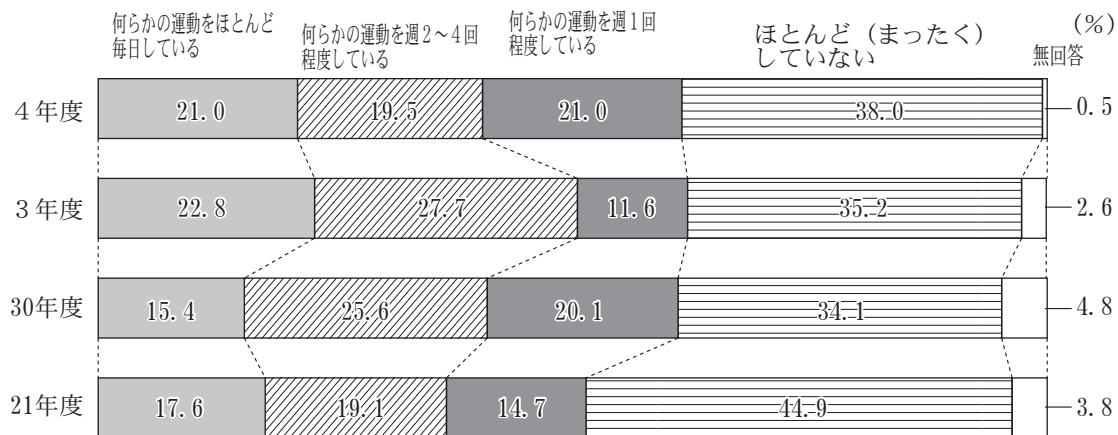

	R 4		R 3		H30		H21	
	人数(人)	割合(%)	人数(人)	割合(%)	人数(人)	割合(%)	人数(人)	割合(%)
1と回答								
男性	19	18.4	33	24.6	27	19.6	62	20.5
女性	24	23.5	28	21.1	18	11.6	46	14.8
男女合計	43	21.0	61	22.8	45	15.4	108	17.6
2と回答								
男性	20	19.4	34	25.4	38	27.5	56	18.5
女性	20	19.6	40	30.1	37	23.9	61	19.7
男女合計	40	19.5	74	27.7	75	25.6	117	19.1
3と回答								
男性	22	21.4	17	12.7	29	21.0	50	16.5
女性	21	20.6	14	10.5	30	19.4	40	12.9
男女合計	43	21.0	31	11.6	59	20.1	90	14.7
4と回答								
男性	41	39.8	47	35.1	39	28.3	125	41.3
女性	37	36.3	47	35.3	61	39.4	150	48.4
男女合計	78	38.0	94	35.2	100	34.1	275	44.9
無回答								
男性	1	1.0	3	2.2	5	3.6	10	3.3
女性	0	0.0	4	3.0	9	5.8	13	4.2
男女合計	1	0.5	7	2.6	14	4.8	23	3.8
全体(人)								
男性	103		134		138		303	
女性	102		133		155		310	
男女合計	205		267		293		613	

○ 令和4年度健康ふくしま21調査（田村市、南相馬市、川俣町、広野町、楡葉町）

	10	割合	20	割合	30	割合	40	割合	50	割合	64	割合	69	割合	70～	割合	全体数	割合
1と回答																		
男性	1	50.0%	0	0.0%	1	10.0%	0	0.0%	2	11.1%	2	14.3%	3	20.0%	10	31.3%	19	18.4%
女性	3	75.0%	0	0.0%	0	0.0%	1	7.1%	6	28.6%	2	28.6%	1	11.1%	11	31.4%	24	23.5%
男女合計	4	66.7%	0	0.0%	1	5.9%	1	4.5%	8	20.5%	4	19.0%	4	16.7%	21	31.3%	43	21.0%
2と回答																		
男性	1	50.0%	1	25.0%	1	10.0%	1	12.5%	2	11.1%	3	21.4%	2	13.3%	9	28.1%	20	19.4%
女性	0	0.0%	2	40.0%	0	0.0%	3	21.4%	4	19.0%	1	14.3%	3	33.3%	7	20.0%	20	19.6%
男女合計	1	16.7%	3	33.3%	1	5.9%	4	18.2%	6	15.4%	4	19.0%	5	20.8%	16	23.9%	40	19.5%
3と回答																		
男性	0	0.0%	1	25.0%	2	20.0%	3	37.5%	4	22.2%	4	28.6%	2	13.3%	6	18.8%	22	21.4%
女性	0	0.0%	0	0.0%	2	28.6%	3	21.4%	3	14.3%	1	14.3%	2	22.2%	10	28.6%	21	20.6%
男女合計	0	0.0%	1	11.1%	4	23.5%	6	27.3%	7	17.9%	5	23.8%	4	16.7%	16	23.9%	43	21.0%
4と回答																		
男性	0	0.0%	2	50.0%	6	60.0%	4	50.0%	10	55.6%	5	35.7%	8	53.3%	6	18.8%	41	39.8%
女性	1	25.0%	3	60.0%	5	71.4%	7	50.0%	8	38.1%	3	42.9%	3	33.3%	7	20.0%	37	36.3%
男女合計	1	16.7%	5	55.6%	11	64.7%	11	50.0%	18	46.2%	8	38.1%	11	45.8%	13	19.4%	78	38.0%
無回答																		
男性	0	0.0%	0	0.0%	0	0.0%	0	0.0%	0	0.0%	0	0.0%	0	0.0%	1	3.1%	1	1.0%
女性	0	0.0%	0	0.0%	0	0.0%	0	0.0%	0	0.0%	0	0.0%	0	0.0%	0	0.0%	0	0.0%
男女合計	0	0.0%	0	0.0%	0	0.0%	0	0.0%	0	0.0%	0	0.0%	0	0.0%	1	1.5%	1	0.5%
全体(人)																		
男性	2		4		10		8		18		14		15		32		103	
女性	4		5		7		14		21		7		9		35		102	
男女合計	6		9		17		22		39		21		24		67		205	

(60歳以上・再掲)

	64	割合	69	割合	70～	割合	80～	割合	90～	割合	全体数	割合
1と回答												
男性	2	14.3%	3	20.0%	7	28.0%	2	50.0%	1	33.3%	15	24.6%
女性	2	28.6%	1	11.1%	6	33.3%	3	23.1%	2	50.0%	14	27.5%
男女合計	4	19.0%	4	16.7%	13	30.2%	5	29.4%	3	42.9%	29	25.9%
2と回答												
男性	3	21.4%	2	13.3%	7	28.0%	2	50.0%	0	0.0%	14	23.0%
女性	1	14.3%	3	33.3%	5	27.8%	2	15.4%	0	0.0%	11	21.6%
男女合計	4	19.0%	5	20.8%	12	27.9%	4	23.5%	0	0.0%	25	22.3%
3と回答												
男性	4	28.6%	2	13.3%	6	24.0%	0	0.0%	0	0.0%	12	19.7%
女性	1	14.3%	2	22.2%	5	27.8%	5	38.5%	0	0.0%	13	25.5%
男女合計	5	23.8%	4	16.7%	11	25.6%	5	29.4%	0	0.0%	25	22.3%
4と回答												
男性	5	35.7%	8	53.3%	5	20.0%	0	0.0%	1	33.3%	19	31.1%
女性	3	42.9%	3	33.3%	2	11.1%	3	23.1%	2	50.0%	13	25.5%
男女合計	8	38.1%	11	45.8%	7	16.3%	3	17.6%	3	42.9%	32	28.6%
無回答												
男性	0	0.0%	0	0.0%	0	0.0%	0	0.0%	1	33.3%	1	1.6%
女性	0	0.0%	0	0.0%	0	0.0%	0	0.0%	0	0.0%	0	0.0%
男女合計	0	0.0%	0	0.0%	0	0.0%	0	0.0%	1	14.3%	1	0.9%
全体(人)												
男性	14		15		25		4		3		61	
女性	7		9		18		13		4		51	
男女合計	21		24		43		17		7		112	

○ 令和3年度健康ふくしま21調査（南相馬市、川内村、浪江町、大熊町）

	10	割合	20	割合	30	割合	40	割合	50	割合	64	割合	69	割合	70～	割合	全体数	割合
1と回答																		
男性	2	100.0%	0	0.0%	0	0.0%	0	0.0%	2	25.0%	7	36.8%	4	15.4%	18	26.1%	33	24.6%
女性	1	16.7%	0	0.0%	0	0.0%	1	11.1%	1	7.1%	7	41.2%	4	22.2%	14	24.1%	28	21.1%
男女合計	3	37.5%	0	0.0%	0	0.0%	1	7.7%	3	13.6%	14	38.9%	8	18.2%	32	25.2%	61	22.8%
2と回答																		
男性	0	0.0%	0	0.0%	0	0.0%	2	50.0%	2	25.0%	2	10.5%	11	42.3%	17	24.6%	34	25.4%
女性	2	33.3%	0	0.0%	3	60.0%	1	11.1%	1	7.1%	2	11.8%	10	55.6%	21	36.2%	40	30.1%
男女合計	2	25.0%	0	0.0%	3	33.3%	3	23.1%	3	13.6%	4	11.1%	21	47.7%	38	29.9%	74	27.7%
3と回答																		
男性	0	0.0%	0	0.0%	1	25.0%	2	50.0%	0	0.0%	2	10.5%	3	11.5%	9	13.0%	17	12.7%
女性	0	0.0%	2	33.3%	0	0.0%	2	22.2%	2	14.3%	1	5.9%	4	22.2%	3	5.2%	14	10.5%
男女合計	0	0.0%	2	25.0%	1	11.1%	4	30.8%	2	9.1%	3	8.3%	7	15.9%	12	9.4%	31	11.6%
4と回答																		
男性	0	0.0%	2	100.0%	3	75.0%	0	0.0%	4	50.0%	8	42.1%	8	30.8%	22	31.9%	47	35.1%
女性	3	50.0%	4	66.7%	2	40.0%	4	44.4%	9	64.3%	7	41.2%	0	0.0%	18	31.0%	47	35.3%
男女合計	3	37.5%	6	75.0%	5	55.6%	4	30.8%	13	59.1%	15	41.7%	8	18.2%	40	31.5%	94	35.2%
無回答																		
男性	0	0.0%	0	0.0%	0	0.0%	0	0.0%	0	0.0%	0	0.0%	0	0.0%	3	4.3%	3	2.2%
女性	0	0.0%	0	0.0%	0	0.0%	1	11.1%	1	7.1%	0	0.0%	0	0.0%	2	3.4%	4	3.0%
男女合計	0	0.0%	0	0.0%	0	0.0%	1	7.7%	1	4.5%	0	0.0%	0	0.0%	5	3.9%	7	2.6%
全体(人)																		
男性	2		2		4		4		8		19		26		69		134	
女性	6		6		5		9		14		17		18		58		133	
男女合計	8		8		9		13		22		36		44		127		267	

(60歳以上・再掲)

	64	割合	69	割合	70～	割合	80～	割合	90～	割合	全体数	割合
1と回答												
男性	7	36.8%	4	15.4%	12	26.7%	5	23.8%	1	33.3%	29	25.4%
女性	7	41.2%	4	22.2%	4	11.8%	8	42.1%	2	40.0%	25	26.9%
男女合計	14	38.9%	8	18.2%	16	20.3%	13	32.5%	3	37.5%	54	26.1%
2と回答												
男性	2	10.5%	11	42.3%	8	17.8%	8	38.1%	1	33.3%	30	26.3%
女性	2	11.8%	10	55.6%	15	44.1%	5	26.3%	1	20.0%	33	35.5%
男女合計	4	11.1%	21	47.7%	23	29.1%	13	32.5%	2	25.0%	63	30.4%
3と回答												
男性	2	10.5%	3	11.5%	6	13.3%	2	9.5%	1	33.3%	14	12.3%
女性	1	5.9%	4	22.2%	2	5.9%	1	5.3%	0	0.0%	8	8.6%
男女合計	3	8.3%	7	15.9%	8	10.1%	3	7.5%	1	12.5%	22	10.6%
4と回答												
男性	8	42.1%	8	30.8%	16	35.6%	6	28.6%	0	0.0%	38	33.3%
女性	7	41.2%	0	0.0%	11	32.4%	5	26.3%	2	40.0%	25	26.9%
男女合計	15	41.7%	8	18.2%	27	34.2%	11	27.5%	2	25.0%	63	30.4%
無回答												
男性	0	0.0%	0	0.0%	3	6.7%	0	0.0%	0	0.0%	3	2.6%
女性	0	0.0%	0	0.0%	2	5.9%	0	0.0%	0	0.0%	2	2.2%
男女合計	0	0.0%	0	0.0%	5	6.3%	0	0.0%	0	0.0%	5	2.4%
全体(人)												
男性	19		26		45		21		3		114	
女性	17		18		34		19		5		93	
男女合計	36		44		79		40		8		207	

○ 平成30年度健康ふくしま21調査（田村市、南相馬市、川俣町、広野町、富岡町、大熊町、浪江町）

	10	割合	20	割合	30	割合	40	割合	50	割合	64	割合	69	割合	70～	割合	全体数	割合
1と回答																		
男性	2	100.0%	0	0.0%	2	22.2%	1	8.3%	1	7.7%	4	28.6%	3	9.7%	14	28.6%	27	19.6%
女性	0	0.0%	0	0.0%	0	0.0%	0	0.0%	0	0.0%	0	0.0%	7	26.9%	11	18.3%	18	11.6%
男女合計	2	100.0%	0	0.0%	2	12.5%	1	4.5%	1	2.5%	4	12.5%	10	17.5%	25	22.9%	45	15.4%
2と回答																		
男性	0	0.0%	1	12.5%	1	11.1%	3	25.0%	2	15.4%	4	28.6%	13	41.9%	14	28.6%	38	27.5%
女性	0	0.0%	2	28.6%	0	0.0%	3	30.0%	6	22.2%	4	22.2%	7	26.9%	15	25.0%	37	23.9%
男女合計	0	0.0%	3	20.0%	1	6.3%	6	27.3%	8	20.0%	8	25.0%	20	35.1%	29	26.6%	75	25.6%
3と回答																		
男性	0	0.0%	4	50.0%	2	22.2%	3	25.0%	4	30.8%	1	7.1%	7	22.6%	8	16.3%	29	21.0%
女性	0	0.0%	1	14.3%	1	14.3%	1	10.0%	6	22.2%	2	11.1%	4	15.4%	15	25.0%	30	19.4%
男女合計	0	0.0%	5	33.3%	3	18.8%	4	18.2%	10	25.0%	3	9.4%	11	19.3%	23	21.1%	59	20.1%
4と回答																		
男性	0	0.0%	3	37.5%	4	44.4%	3	25.0%	6	46.2%	5	35.7%	7	22.6%	11	22.4%	39	28.3%
女性	0	0.0%	4	57.1%	6	85.7%	5	50.0%	15	55.6%	11	61.1%	8	30.8%	12	20.0%	61	39.4%
男女合計	0	0.0%	7	46.7%	10	62.5%	8	36.4%	21	52.5%	16	50.0%	15	26.3%	23	21.1%	100	34.1%
無回答																		
男性	0	0.0%	0	0.0%	0	0.0%	2	16.7%	0	0.0%	0	0.0%	1	3.2%	2	4.1%	5	3.6%
女性	0	0.0%	0	0.0%	0	0.0%	1	10.0%	0	0.0%	1	5.6%	0	0.0%	7	11.7%	9	5.8%
男女合計	0	0.0%	0	0.0%	0	0.0%	3	13.6%	0	0.0%	1	3.1%	1	1.8%	9	8.3%	14	4.8%
全体(人)																		
男性	2		8		9		12		13		14		31		49		138	
女性	0		7		7		10		27		18		26		60		155	
男女合計	2		15		16		22		40		32		57		109		293	

(60歳以上・再掲)

	64	割合	69	割合	70～	割合	80～	割合	90～	割合	全体数	割合
1と回答												
男性	4	28.6%	3	9.7%	7	24.1%	7	36.8%	0	0.0%	21	22.3%
女性	0	0.0%	7	26.9%	8	24.2%	2	10.0%	1	14.3%	18	17.3%
男女合計	4	12.5%	10	17.5%	15	24.2%	9	23.1%	1	12.5%	39	19.7%
2と回答												
男性	4	28.6%	13	41.9%	9	31.0%	4	21.1%	1	100.0%	31	33.0%
女性	4	22.2%	7	26.9%	9	27.3%	6	30.0%	0	0.0%	26	25.0%
男女合計	8	25.0%	20	35.1%	18	29.0%	10	25.6%	1	12.5%	57	28.8%
3と回答												
男性	1	7.1%	7	22.6%	6	20.7%	2	10.5%	0	0.0%	16	17.0%
女性	2	11.1%	4	15.4%	9	27.3%	6	30.0%	0	0.0%	21	20.2%
男女合計	3	9.4%	11	19.3%	15	24.2%	8	20.5%	0	0.0%	37	18.7%
4と回答												
男性	5	35.7%	7	22.6%	7	24.1%	4	21.1%	0	0.0%	23	24.5%
女性	11	61.1%	8	30.8%	4	12.1%	5	25.0%	3	42.9%	31	29.8%
男女合計	16	50.0%	15	26.3%	11	17.7%	9	23.1%	3	37.5%	54	27.3%
無回答												
男性	0	0.0%	1	3.2%	0	0.0%	2	10.5%	0	0.0%	3	3.2%
女性	1	5.6%	0	0.0%	3	9.1%	1	5.0%	3	42.9%	8	7.7%
男女合計	1	3.1%	1	1.8%	3	4.8%	3	7.7%	3	37.5%	11	5.6%
全体(人)												
男性	14		31		29		19		1		94	
女性	18		26		33		20		7		104	
男女合計	32		57		62		39		8		198	

○ 平成21年度県民健康調査（田村市、南相馬市、富岡町、浪江町、葛尾村）

	10	割合	20	割合	30	割合	40	割合	50	割合	64	割合	69	割合	70～	割合	全体数	割合
1と回答																		
男性	4	23.5%	3	10.0%	1	3.0%	3	23.1%	9	13.4%	10	23.3%	8	28.6%	24	33.3%	62	20.5%
女性	1	8.3%	0	0.0%	1	3.2%	2	6.5%	9	13.6%	7	19.4%	7	24.1%	19	22.6%	46	14.8%
男女合計	5	17.2%	3	5.9%	2	3.1%	5	11.4%	18	13.5%	17	21.5%	15	26.3%	43	27.6%	108	17.6%
2と回答																		
男性	5	29.4%	5	16.7%	4	12.1%	2	15.4%	11	16.4%	8	18.6%	4	14.3%	17	23.6%	56	18.5%
女性	5	41.7%	2	9.5%	3	9.7%	9	29.0%	11	16.7%	13	36.1%	5	17.2%	13	15.5%	61	19.7%
男女合計	10	34.5%	7	13.7%	7	10.9%	11	25.0%	22	16.5%	21	26.6%	9	15.8%	30	19.2%	117	19.1%
3と回答																		
男性	4	23.5%	7	23.3%	9	27.3%	1	7.7%	7	10.4%	6	14.0%	8	28.6%	8	11.1%	50	16.5%
女性	1	8.3%	2	9.5%	2	6.5%	3	9.7%	11	16.7%	4	11.1%	7	24.1%	10	11.9%	40	12.9%
男女合計	5	17.2%	9	17.6%	11	17.2%	4	9.1%	18	13.5%	10	12.7%	15	26.3%	18	11.5%	90	14.7%
4と回答																		
男性	4	23.5%	12	40.0%	18	54.5%	7	53.8%	39	58.2%	19	44.2%	8	28.6%	18	25.0%	125	41.3%
女性	4	33.3%	16	76.2%	25	80.6%	16	51.6%	34	51.5%	11	30.6%	10	34.5%	34	40.5%	150	48.4%
男女合計	8	27.6%	28	54.9%	43	67.2%	23	52.3%	73	54.9%	30	38.0%	18	31.6%	52	33.3%	275	44.9%
無回答																		
男性	0	0.0%	3	10.0%	1	3.0%	0	0.0%	1	1.5%	0	0.0%	0	0.0%	5	6.9%	10	3.3%
女性	1	8.3%	1	4.8%	0	0.0%	1	3.2%	1	1.5%	1	2.8%	0	0.0%	8	9.5%	13	4.2%
男女合計	1	3.4%	4	7.8%	1	1.6%	1	2.3%	2	1.5%	1	1.3%	0	0.0%	13	8.3%	23	3.8%
全体(人)																		
男性	17		30		33		13		67		43		28		72		303	
女性	12		21		31		31		66		36		29		84		310	
男女合計	29		51		64		44		133		79		57		156		613	

(60歳以上・再掲)

	64	割合	69	割合	70～	割合	80～	割合	90～	割合	全体数	割合
1と回答												
男性	10	23.3%	8	28.6%	19	35.2%	4	26.7%	1	33.3%	42	29.4%
女性	7	19.4%	7	24.1%	14	28.6%	5	15.2%	0	0.0%	33	22.1%
男女合計	17	21.5%	15	26.3%	33	32.0%	9	18.8%	1	20.0%	75	25.7%
2と回答												
男性	8	18.6%	4	14.3%	12	22.2%	4	26.7%	1	33.3%	29	20.3%
女性	13	36.1%	5	17.2%	10	20.4%	3	9.1%	0	0.0%	31	20.8%
男女合計	21	26.6%	9	15.8%	22	21.4%	7	14.6%	1	20.0%	60	20.5%
3と回答												
男性	6	14.0%	8	28.6%	8	14.8%	0	0.0%	0	0.0%	22	15.4%
女性	4	11.1%	7	24.1%	6	12.2%	4	12.1%	0	0.0%	21	14.1%
男女合計	10	12.7%	15	26.3%	14	13.6%	4	8.3%	0	0.0%	43	14.7%
4と回答												
男性	19	44.2%	8	28.6%	12	22.2%	5	33.3%	1	33.3%	45	31.5%
女性	11	30.6%	10	34.5%	14	28.6%	18	54.5%	2	100.0%	55	36.9%
男女合計	30	38.0%	18	31.6%	26	25.2%	23	47.9%	3	60.0%	100	34.2%
無回答												
男性	0	0.0%	0	0.0%	3	5.6%	2	13.3%	0	0.0%	5	3.5%
女性	1	2.8%	0	0.0%	5	10.2%	3	9.1%	0	0.0%	9	6.0%
男女合計	1	1.3%	0	0.0%	8	7.8%	5	10.4%	0	0.0%	14	4.8%
全体(人)												
男性	43		28		54		15		3		143	
女性	36		29		49		33		2		149	
男女合計	79		57		103		48		5		292	

(2) 運動時間

付問 問10で1～3を選んだ方におたずねします。1回の運動時間はどれくらいですか。複数の運動をしている方は、もっとも運動時間の長いものについてお答えください。

- 1 15分未満
 - 2 15～30分未満
 - 3 30分以上

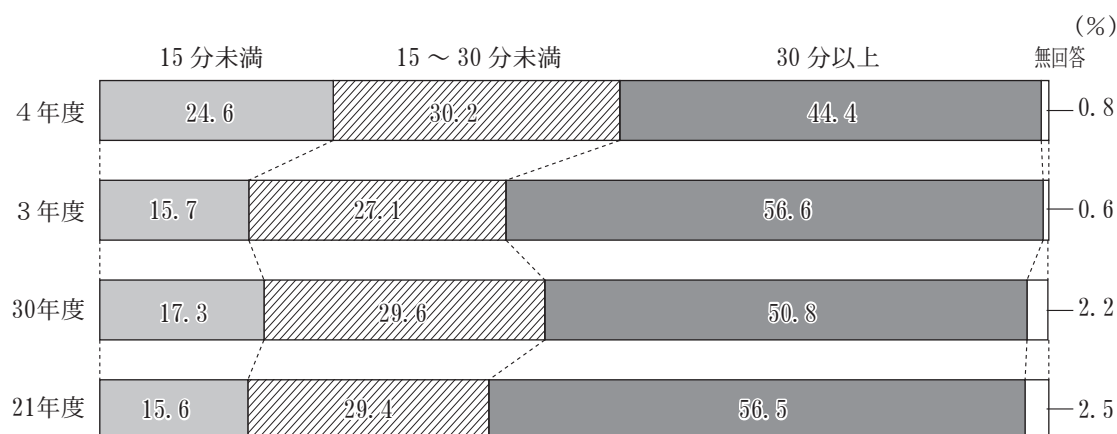

	R 4		R 3		H30		H21	
	人数(人)	割合(%)	人数(人)	割合(%)	人数(人)	割合(%)	人数(人)	割合(%)
1と回答								
男性	8	13.1	13	15.5	12	12.8	16	9.5
女性	23	35.4	13	15.9	19	22.4	33	22.4
男女合計	31	24.6	26	15.7	31	17.3	49	15.6
2と回答								
男性	17	27.9	20	23.8	31	33.0	37	22.0
女性	21	32.3	25	30.5	22	25.9	43	29.3
男女合計	38	30.2	45	27.1	53	29.6	80	25.4
3と回答								
男性	35	57.4	51	60.7	49	52.1	112	66.7
女性	21	32.3	43	52.4	42	49.4	66	44.9
男女合計	56	44.4	94	56.6	91	50.8	178	56.5
無回答								
男性	1	1.6	0	0.0	2	2.1	3	1.8
女性	0	0.0	1	1.2	2	2.4	5	3.4
男女合計	1	0.8	1	0.6	4	2.2	8	2.5
全体(人)								
男性	61		84		94		168	
女性	65		82		85		147	
男女合計	126		166		179		315	

○ 令和4年度健康ふくしま21調査（田村市、南相馬市、川俣町、広野町、楡葉町）

	10	割合	20	割合	30	割合	40	割合	50	割合	64	割合	69	割合	70～	割合	全体数	割合
1と回答																		
男性	0	0.0%	0	0.0%	0	0.0%	0	0.0%	2	25.0%	2	22.2%	1	14.3%	3	12.0%	8	13.1%
女性	0	0.0%	0	0.0%	0	0.0%	0	0.0%	4	30.8%	3	75.0%	3	50.0%	13	46.4%	23	35.4%
男女合計	0	0.0%	0	0.0%	0	0.0%	0	0.0%	6	28.6%	5	38.5%	4	30.8%	16	30.2%	31	24.6%
2と回答																		
男性	0	0.0%	1	50.0%	1	25.0%	1	25.0%	2	25.0%	1	11.1%	4	57.1%	7	28.0%	17	27.9%
女性	0	0.0%	2	100.0%	0	0.0%	4	57.1%	4	30.8%	1	25.0%	2	33.3%	8	28.6%	21	32.3%
男女合計	0	0.0%	3	75.0%	1	16.7%	5	45.5%	6	28.6%	2	15.4%	6	46.2%	15	28.3%	38	30.2%
3と回答																		
男性	2	100.0%	1	50.0%	3	75.0%	3	75.0%	4	50.0%	6	66.7%	2	28.6%	14	56.0%	35	57.4%
女性	3	100.0%	0	0.0%	2	100.0%	3	42.9%	5	38.5%	0	0.0%	1	16.7%	7	25.0%	21	32.3%
男女合計	5	100.0%	1	25.0%	5	83.3%	6	54.5%	9	42.9%	6	46.2%	3	23.1%	21	39.6%	56	44.4%
無回答																		
男性	0	0.0%	0	0.0%	0	0.0%	0	0.0%	0	0.0%	0	0.0%	0	0.0%	1	4.0%	1	1.6%
女性	0	0.0%	0	0.0%	0	0.0%	0	0.0%	0	0.0%	0	0.0%	0	0.0%	0	0.0%	0	0.0%
男女合計	0	0.0%	0	0.0%	0	0.0%	0	0.0%	0	0.0%	0	0.0%	0	0.0%	1	1.9%	1	0.8%
全体(人)																		
男性	2		2		4		4		8		9		7		25		61	
女性	3		2		2		7		13		4		6		28		65	
男女合計	5		4		6		11		21		13		13		53		126	

(60歳以上・再掲)

	64	割合	69	割合	70～	割合	80～	割合	90～	割合	全体数	割合
1と回答												
男性	2	22.2%	1	14.3%	1	5.0%	1	25.0%	1	100.0%	6	14.6%
女性	3	75.0%	3	50.0%	6	37.5%	6	60.0%	1	50.0%	19	50.0%
男女合計	5	38.5%	4	30.8%	7	19.4%	7	50.0%	2	66.7%	25	31.6%
2と回答												
男性	1	11.1%	4	57.1%	5	25.0%	2	50.0%	0	0.0%	12	29.3%
女性	1	25.0%	2	33.3%	4	25.0%	3	30.0%	1	50.0%	11	28.9%
男女合計	2	15.4%	6	46.2%	9	25.0%	5	35.7%	1	33.3%	23	29.1%
3と回答												
男性	6	66.7%	2	28.6%	13	65.0%	1	25.0%	0	0.0%	22	53.7%
女性	0	0.0%	1	16.7%	6	37.5%	1	10.0%	0	0.0%	8	21.1%
男女合計	6	46.2%	3	23.1%	19	52.8%	2	14.3%	0	0.0%	30	38.0%
無回答												
男性	0	0.0%	0	0.0%	1	5.0%	0	0.0%	0	0.0%	1	2.4%
女性	0	0.0%	0	0.0%	0	0.0%	0	0.0%	0	0.0%	0	0.0%
男女合計	0	0.0%	0	0.0%	1	2.8%	0	0.0%	0	0.0%	1	1.3%
全体(人)												
男性	9		7		20		4		1		41	
女性	4		6		16		10		2		38	
男女合計	13		13		36		14		3		79	

○ 令和3年度健康ふくしま21調査（南相馬市、川内村、浪江町、大熊町）

	10	割合	20	割合	30	割合	40	割合	50	割合	64	割合	69	割合	70～	割合	全体数	割合
1と回答																		
男性	0	0.0%	0	0.0%	0	0.0%	1	25.0%	0	0.0%	1	9.1%	1	5.6%	10	22.7%	13	15.5%
女性	0	0.0%	1	50.0%	0	0.0%	0	0.0%	1	25.0%	1	10.0%	2	11.1%	8	21.1%	13	15.9%
男女合計	0	0.0%	1	50.0%	0	0.0%	1	12.5%	1	12.5%	2	9.5%	3	8.3%	18	22.0%	26	15.7%
2と回答																		
男性	0	0.0%	0	0.0%	0	0.0%	1	25.0%	1	25.0%	3	27.3%	8	44.4%	7	15.9%	20	23.8%
女性	0	0.0%	1	50.0%	1	33.3%	3	75.0%	0	0.0%	4	40.0%	4	22.2%	12	31.6%	25	30.5%
男女合計	0	0.0%	1	50.0%	1	25.0%	4	50.0%	1	12.5%	7	33.3%	12	33.3%	19	23.2%	45	27.1%
3と回答																		
男性	2	100.0%	0	0.0%	1	100.0%	2	50.0%	3	75.0%	7	63.6%	9	50.0%	27	61.4%	51	60.7%
女性	3	100.0%	0	0.0%	2	66.7%	1	25.0%	3	75.0%	5	50.0%	12	66.7%	17	44.7%	43	52.4%
男女合計	5	100.0%	0	0.0%	3	75.0%	3	37.5%	6	75.0%	12	57.1%	21	58.3%	44	53.7%	94	56.6%
無回答																		
男性	0	0.0%	0	0.0%	0	0.0%	0	0.0%	0	0.0%	0	0.0%	0	0.0%	0	0.0%	0	0.0%
女性	0	0.0%	0	0.0%	0	0.0%	0	0.0%	0	0.0%	0	0.0%	0	0.0%	1	2.6%	1	1.2%
男女合計	0	0.0%	0	0.0%	0	0.0%	0	0.0%	0	0.0%	0	0.0%	0	0.0%	1	1.2%	1	0.6%
全体(人)																		
男性	2		0		1		4		4		11		18		44		84	
女性	3		2		3		4		4		10		18		38		82	
男女合計	5		2		4		8		8		21		36		82		166	

(60歳以上・再掲)

	64	割合	69	割合	70～	割合	80～	割合	90～	割合	全体数	割合
1と回答												
男性	1	9.1%	1	5.6%	8	30.8%	1	6.7%	1	33.3%	12	16.4%
女性	1	10.0%	2	11.1%	4	19.0%	4	28.6%	0	0.0%	11	16.7%
男女合計	2	9.5%	3	8.3%	12	25.5%	5	17.2%	1	16.7%	23	16.5%
2と回答												
男性	3	27.3%	8	44.4%	3	11.5%	3	20.0%	1	33.3%	18	24.7%
女性	4	40.0%	4	22.2%	7	33.3%	4	28.6%	1	33.3%	20	30.3%
男女合計	7	33.3%	12	33.3%	10	21.3%	7	24.1%	2	33.3%	38	27.3%
3と回答												
男性	7	63.6%	9	50.0%	15	57.7%	11	73.3%	1	33.3%	43	58.9%
女性	5	50.0%	12	66.7%	10	47.6%	6	42.9%	1	33.3%	34	51.5%
男女合計	12	57.1%	21	58.3%	25	53.2%	17	58.6%	2	33.3%	77	55.4%
無回答												
男性	0	0.0%	0	0.0%	0	0.0%	0	0.0%	0	0.0%	0	0.0%
女性	0	0.0%	0	0.0%	0	0.0%	0	0.0%	1	33.3%	1	1.5%
男女合計	0	0.0%	0	0.0%	0	0.0%	0	0.0%	1	16.7%	1	0.7%
全体(人)												
男性	11		18		26		15		3		73	
女性	10		18		21		14		3		66	
男女合計	21		36		47		29		6		139	

○ 平成30年度健康ふくしま21調査（田村市、南相馬市、川俣町、広野町、富岡町、大熊町、浪江町）

	10	割合	20	割合	30	割合	40	割合	50	割合	64	割合	69	割合	70～	割合	全体数	割合
1と回答																		
男性	0	0.0%	0	0.0%	1	20.0%	1	14.3%	1	14.3%	1	11.1%	2	8.7%	6	16.7%	12	12.8%
女性	0	0.0%	0	0.0%	1	100.0%	1	25.0%	4	33.3%	0	0.0%	4	22.2%	9	22.0%	19	22.4%
男女合計	0	0.0%	0	0.0%	2	33.3%	2	18.2%	5	26.3%	1	6.7%	6	14.6%	15	19.5%	31	17.3%
2と回答																		
男性	0	0.0%	2	40.0%	0	0.0%	1	14.3%	4	57.1%	1	11.1%	4	17.4%	19	52.8%	31	33.0%
女性	0	0.0%	1	33.3%	0	0.0%	1	25.0%	1	8.3%	2	33.3%	4	22.2%	13	31.7%	22	25.9%
男女合計	0	0.0%	3	37.5%	0	0.0%	2	18.2%	5	26.3%	3	20.0%	8	19.5%	32	41.6%	53	29.6%
3と回答																		
男性	2	100.0%	3	60.0%	4	80.0%	5	71.4%	2	28.6%	7	77.8%	17	73.9%	9	25.0%	49	52.1%
女性	0	0.0%	2	66.7%	0	0.0%	2	50.0%	7	58.3%	4	66.7%	9	50.0%	18	43.9%	42	49.4%
男女合計	2	100.0%	5	62.5%	4	66.7%	7	63.6%	9	47.4%	11	73.3%	26	63.4%	27	35.1%	91	50.8%
無回答																		
男性	0	0.0%	0	0.0%	0	0.0%	0	0.0%	0	0.0%	0	0.0%	0	0.0%	2	5.6%	2	2.1%
女性	0	0.0%	0	0.0%	0	0.0%	0	0.0%	0	0.0%	0	0.0%	1	5.6%	1	2.4%	2	2.4%
男女合計	0	0.0%	0	0.0%	0	0.0%	0	0.0%	0	0.0%	0	0.0%	1	2.4%	3	3.9%	4	2.2%
全体(人)																		
男性	2		5		5		7		7		9		23		36		94	
女性	0		3		1		4		12		6		18		41		85	
男女合計	2		8		6		11		19		15		41		77		179	

(60歳以上・再掲)

	64	割合	69	割合	70～	割合	80～	割合	90～	割合	全体数	割合
1と回答												
男性	1	11.1%	2	8.7%	2	9.1%	4	30.8%	0	0.0%	9	13.2%
女性	0	0.0%	4	22.2%	6	23.1%	3	21.4%	0	0.0%	13	20.0%
男女合計	1	6.7%	6	14.6%	8	16.7%	7	25.9%	0	0.0%	22	16.5%
2と回答												
男性	1	11.1%	4	17.4%	13	59.1%	6	46.2%	0	0.0%	24	35.3%
女性	2	33.3%	4	22.2%	7	26.9%	5	35.7%	1	100.0%	19	29.2%
男女合計	3	20.0%	8	19.5%	20	41.7%	11	40.7%	1	50.0%	43	32.3%
3と回答												
男性	7	77.8%	17	73.9%	6	27.3%	3	23.1%	0	0.0%	33	48.5%
女性	4	66.7%	9	50.0%	12	46.2%	6	42.9%	0	0.0%	31	47.7%
男女合計	11	73.3%	26	63.4%	18	37.5%	9	33.3%	0	0.0%	64	48.1%
無回答												
男性	0	0.0%	0	0.0%	1	4.5%	0	0.0%	1	100.0%	2	2.9%
女性	0	0.0%	1	5.6%	1	3.8%	0	0.0%	0	0.0%	2	3.1%
男女合計	0	0.0%	1	2.4%	2	4.2%	0	0.0%	1	50.0%	4	3.0%
全体(人)												
男性	9		23		22		13		1		68	
女性	6		18		26		14		1		65	
男女合計	15		41		48		27		2		133	

○ 平成21年度県民健康調査（田村市、南相馬市、富岡町、浪江町、葛尾村）

	10	割合	20	割合	30	割合	40	割合	50	割合	64	割合	69	割合	70～	割合	全体数	割合
1と回答																		
男性	0	0.0%	2	13.3%	1	7.1%	0	0.0%	3	11.1%	2	8.3%	4	20.0%	4	8.2%	16	9.5%
女性	1	14.3%	1	25.0%	2	33.3%	3	21.4%	6	19.4%	2	8.3%	5	26.3%	13	31.0%	33	22.4%
男女合計	1	5.0%	3	15.8%	3	15.0%	3	15.0%	9	15.5%	4	8.3%	9	23.1%	17	18.7%	49	15.6%
2と回答																		
男性	1	7.7%	4	26.7%	1	7.1%	1	16.7%	10	37.0%	7	29.2%	5	25.0%	8	16.3%	37	22.0%
女性	0	0.0%	2	50.0%	2	33.3%	6	42.9%	14	45.2%	6	25.0%	3	15.8%	10	23.8%	43	29.3%
男女合計	1	5.0%	6	31.6%	3	15.0%	7	35.0%	24	41.4%	13	27.1%	8	20.5%	18	19.8%	80	25.4%
3と回答																		
男性	12	92.3%	9	60.0%	11	78.6%	5	83.3%	14	51.9%	14	58.3%	11	55.0%	36	73.5%	112	66.7%
女性	6	85.7%	1	25.0%	2	33.3%	5	35.7%	10	32.3%	16	66.7%	11	57.9%	15	35.7%	66	44.9%
男女合計	18	90.0%	10	52.6%	13	65.0%	10	50.0%	24	41.4%	30	62.5%	22	56.4%	51	56.0%	178	56.5%
無回答																		
男性	0	0.0%	0	0.0%	1	7.1%	0	0.0%	0	0.0%	1	4.2%	0	0.0%	1	2.0%	3	1.8%
女性	0	0.0%	0	0.0%	0	0.0%	0	0.0%	1	3.2%	0	0.0%	0	0.0%	4	9.5%	5	3.4%
男女合計	0	0.0%	0	0.0%	1	5.0%	0	0.0%	1	1.7%	1	2.1%	0	0.0%	5	5.5%	8	2.5%
全体(人)																		
男性	13		15		14		6		27		24		20		49		168	
女性	7		4		6		14		31		24		19		42		147	
男女合計	20		19		20		20		58		48		39		91		315	

(60歳以上・再掲)

	64	割合	69	割合	70～	割合	80～	割合	90～	割合	全体数	割合
1と回答												
男性	2	8.3%	4	20.0%	2	5.1%	1	12.5%	1	50.0%	10	10.8%
女性	2	8.3%	5	26.3%	10	33.3%	3	25.0%	0	0.0%	20	23.5%
男女合計	4	8.3%	9	23.1%	12	17.4%	4	20.0%	1	50.0%	30	16.9%
2と回答												
男性	7	29.2%	5	25.0%	7	17.9%	1	12.5%	0	0.0%	20	21.5%
女性	6	25.0%	3	15.8%	7	23.3%	3	25.0%	0	0.0%	19	22.4%
男女合計	13	27.1%	8	20.5%	14	20.3%	4	20.0%	0	0.0%	39	21.9%
3と回答												
男性	14	58.3%	11	55.0%	29	74.4%	6	75.0%	1	50.0%	61	65.6%
女性	16	66.7%	11	57.9%	10	33.3%	5	41.7%	0	0.0%	42	49.4%
男女合計	30	62.5%	22	56.4%	39	56.5%	11	55.0%	1	50.0%	103	57.9%
無回答												
男性	1	4.2%	0	0.0%	1	2.6%	0	0.0%	0	0.0%	2	2.2%
女性	0	0.0%	0	0.0%	3	10.0%	1	8.3%	0	0.0%	4	4.7%
男女合計	1	2.1%	0	0.0%	4	5.8%	1	5.0%	0	0.0%	6	3.4%
全体(人)												
男性	24		20		39		8		2		93	
女性	24		19		30		12		0		85	
男女合計	48		39		69		20		2		178	

(3) 運動習慣の状況（満20歳以上対象）

「(1)運動の状況」及び「(2)運動時間」の回答に関するクロス集計）

○ 令和4年度健康ふくしま21調査（田村市、南相馬市、川俣町、広野町、檜葉町）

	20	割合	30	割合	40	割合	50	割合	64	割合	69	割合	70	割合	80	割合	90	割合	全体数	割合
何らかの運動をほとんど毎日、15分未満している。																				
男性	0	0.0%	0	0.0%	0	0.0%	0	0.0%	0	0.0%	1	6.7%	1	4.0%	1	25.0%	1	33.3%	4	4.0%
女性	0	0.0%	0	0.0%	0	0.0%	3	14.3%	2	28.6%	1	11.1%	3	16.7%	1	7.7%	1	25.0%	11	11.2%
男女合計	0	0.0%	0	0.0%	0	0.0%	3	7.7%	2	9.5%	2	8.3%	4	9.3%	2	11.8%	2	28.6%	15	7.5%
何らかの運動をほとんど毎日、15～30分未満している。																				
男性	0	0.0%	0	0.0%	0	0.0%	1	5.6%	0	0.0%	1	6.7%	1	4.0%	1	25.0%	0	0.0%	4	4.0%
女性	0	0.0%	0	0.0%	1	7.1%	2	9.5%	0	0.0%	0	0.0%	2	11.1%	2	15.4%	1	25.0%	8	8.2%
男女合計	0	0.0%	0	0.0%	1	4.5%	3	7.7%	0	0.0%	1	4.2%	3	7.0%	3	17.6%	1	14.3%	12	6.0%
何らかの運動をほとんど毎日、30分以上している。																				
男性	0	0.0%	1	10.0%	0	0.0%	1	5.6%	2	14.3%	1	6.7%	4	16.0%	0	0.0%	0	0.0%	9	8.9%
女性	0	0.0%	0	0.0%	0	0.0%	1	4.8%	0	0.0%	0	0.0%	1	5.6%	0	0.0%	0	0.0%	2	2.0%
男女合計	0	0.0%	1	5.9%	0	0.0%	2	5.1%	2	9.5%	1	4.2%	5	11.6%	0	0.0%	0	0.0%	11	5.5%
何らかの運動をほとんど毎日している。(時間無回答)																				
男性	0	0.0%	0	0.0%	0	0.0%	0	0.0%	0	0.0%	0	0.0%	1	4.0%	0	0.0%	0	0.0%	1	1.0%
女性	0	0.0%	0	0.0%	0	0.0%	0	0.0%	0	0.0%	0	0.0%	0	0.0%	0	0.0%	0	0.0%	0	0.0%
男女合計	0	0.0%	0	0.0%	0	0.0%	0	0.0%	0	0.0%	0	0.0%	1	2.3%	0	0.0%	0	0.0%	1	0.5%
何らかの運動を週2～4回程度、15分未満している。																				
男性	0	0.0%	0	0.0%	0	0.0%	0	0.0%	1	7.1%	0	0.0%	0	0.0%	0	0.0%	0	0.0%	1	1.0%
女性	0	0.0%	0	0.0%	0	0.0%	1	4.8%	0	0.0%	0	0.0%	1	5.6%	2	15.4%	0	0.0%	4	4.1%
男女合計	0	0.0%	0	0.0%	0	0.0%	1	2.6%	1	4.8%	0	0.0%	1	2.3%	2	11.8%	0	0.0%	5	2.5%
何らかの運動を週2～4回程度、15～30分未満している。																				
男性	0	0.0%	0	0.0%	0	0.0%	1	5.6%	0	0.0%	1	6.7%	0	0.0%	1	25.0%	0	0.0%	3	3.0%
女性	2	40.0%	0	0.0%	2	14.3%	2	9.5%	1	14.3%	2	22.2%	1	5.6%	0	0.0%	0	0.0%	10	10.2%
男女合計	2	22.2%	0	0.0%	2	9.1%	3	7.7%	1	4.8%	3	12.5%	1	2.3%	1	5.9%	0	0.0%	13	6.5%
何らかの運動を週2～4回程度、30分以上している。																				
男性	1	25.0%	1	10.0%	1	12.5%	1	5.6%	2	14.3%	1	6.7%	7	28.0%	1	25.0%	0	0.0%	15	14.9%
女性	0	0.0%	0	0.0%	1	7.1%	1	4.8%	0	0.0%	1	11.1%	3	16.7%	0	0.0%	0	0.0%	6	6.1%
男女合計	1	11.1%	1	5.9%	2	9.1%	2	5.1%	2	9.5%	2	8.3%	10	23.3%	1	5.9%	0	0.0%	21	10.6%
何らかの運動を週2～4回程度している。(時間無回答)																				
男性	0	0.0%	0	0.0%	0	0.0%	0	0.0%	0	0.0%	0	0.0%	0	0.0%	0	0.0%	0	0.0%	0	0.0%
女性	0	0.0%	0	0.0%	0	0.0%	0	0.0%	0	0.0%	0	0.0%	0	0.0%	0	0.0%	0	0.0%	0	0.0%
男女合計	0	0.0%	0	0.0%	0	0.0%	0	0.0%	0	0.0%	0	0.0%	0	0.0%	0	0.0%	0	0.0%	0	0.0%
何らかの運動を週1回程度、15分未満している。																				
男性	0	0.0%	0	0.0%	0	0.0%	2	11.1%	1	7.1%	0	0.0%	0	0.0%	0	0.0%	0	0.0%	3	3.0%
女性	0	0.0%	0	0.0%	0	0.0%	0	0.0%	1	14.3%	2	22.2%	2	11.1%	3	23.1%	0	0.0%	8	8.2%
男女合計	0	0.0%	0	0.0%	0	0.0%	2	5.1%	2	9.5%	2	8.3%	2	4.7%	3	17.6%	0	0.0%	11	5.5%
何らかの運動を週1回程度、15～30分未満している。																				
男性	1	25.0%	1	10.0%	1	12.5%	0	0.0%	1	7.1%	2	13.3%	4	16.0%	0	0.0%	0	0.0%	10	9.9%
女性	0	0.0%	0	0.0%	1	7.1%	0	0.0%	0	0.0%	0	0.0%	1	5.6%	1	7.7%	0	0.0%	3	3.1%
男女合計	1	11.1%	1	5.9%	2	9.1%	0	0.0%	1	4.8%	2	8.3%	5	11.6%	1	5.9%	0	0.0%	13	6.5%
何らかの運動を週1回程度、30分以上している。																				
男性	0	0.0%	1	10.0%	2	25.0%	2	11.1%	2	14.3%	0	0.0%	2	8.0%	0	0.0%	0	0.0%	9	8.9%
女性	0	0.0%	2	28.6%	2	14.3%	3	14.3%	0	0.0%	0	0.0%	2	11.1%	1	7.7%	0	0.0%	10	10.2%
男女合計	0	0.0%	3	17.6%	4	18.2%	5	12.8%	2	9.5%	0	0.0%	4	9.3%	1	5.9%	0	0.0%	19	9.5%
何らかの運動を週1回程度している。(時間無回答)																				
男性	0	0.0%	0	0.0%	0	0.0%	0	0.0%	0	0.0%	0	0.0%	0	0.0%	0	0.0%	0	0.0%	0	0.0%
女性	0	0.0%	0	0.0%	0	0.0%	0	0.0%	0	0.0%	0	0.0%	0	0.0%	0	0.0%	0	0.0%	0	0.0%
男女合計	0	0.0%	0	0.0%	0	0.0%	0	0.0%	0	0.0%	0	0.0%	0	0.0%	0	0.0%	0	0.0%	0	0.0%
ほとんど(まったく)していない。																				
男性	2	50.0%	6	60.0%	4	50.0%	10	55.6%	5	35.7%	8	53.3%	5	20.0%	0	0.0%	1	33.3%	41	40.6%
女性	3	60.0%	5	71.4%	7	50.0%	8	38.1%	3	42.9%	3	33.3%	2	11.1%	3	23.1%	2	50.0%	36	36.7%
男女合計	5	55.6%	11	64.7%	11	50.0%	18	46.2%	8	38.1%	11	45.8%	7	16.3%	3	17.6%	3	42.9%	77	38.7%
無回答																				
男性	0	0.0%	0	0.0%	0	0.0%	0	0.0%	0	0.0%	0	0.0%	0	0.0%	0	0.0%	1	33.3%	1	1.0%
女性	0	0.0%	0	0.0%	0	0.0%	0	0.0%	0	0.0%	0	0.0%	0	0.0%	0	0.0%	0	0.0%	0	0.0%
男女合計	0	0.0%	0	0.0%	0	0.0%	0	0.0%	0	0.0%	0	0.0%	0	0.0%	0	0.0%	1	14.3%	1	0.5%
全体(人)																				
男性	4		10		8		18		14		15		25		4		3		101	
女性	5		7		14		21		7		9		18		13		4		98	
男女合計	9		17		22		39		21		24		43		17		7		199	

○ 令和3年度健康ふくしま21調査（南相馬市、川内村、浪江町、大熊町）

	20	割合	30	割合	40	割合	50	割合	64	割合	69	割合	70	割合	80	割合	90	割合	全体数	割合
何らかの運動をほとんど毎日、15分未満している。																				
男性	0	0.0%	0	0.0%	0	0.0%	0	0.0%	1	5.3%	1	3.8%	4	8.9%	0	0.0%	0	0.0%	6	4.5%
女性	0	0.0%	0	0.0%	0	0.0%	0	0.0%	1	5.9%	0	0.0%	1	2.9%	4	21.1%	0	0.0%	6	4.7%
男女合計	0	0.0%	0	0.0%	0	0.0%	0	0.0%	2	5.6%	1	2.3%	5	6.3%	4	10.0%	0	0.0%	12	4.6%
何らかの運動をほとんど毎日、15～30分未満している。																				
男性	0	0.0%	0	0.0%	0	0.0%	1	12.5%	2	10.5%	1	3.8%	0	0.0%	2	9.5%	0	0.0%	6	4.5%
女性	0	0.0%	0	0.0%	1	11.1%	0	0.0%	3	17.6%	0	0.0%	1	2.9%	1	5.3%	1	20.0%	7	5.5%
男女合計	0	0.0%	0	0.0%	1	7.7%	1	4.5%	5	13.9%	1	2.3%	1	1.3%	3	7.5%	1	12.5%	13	5.0%
何らかの運動をほとんど毎日、30分以上している。																				
男性	0	0.0%	0	0.0%	0	0.0%	1	12.5%	4	21.1%	2	7.7%	8	17.8%	3	14.3%	1	33.3%	19	14.4%
女性	0	0.0%	0	0.0%	0	0.0%	1	7.1%	3	17.6%	4	22.2%	2	5.9%	3	15.8%	1	20.0%	14	11.0%
男女合計	0	0.0%	0	0.0%	0	0.0%	2	9.1%	7	19.4%	6	13.6%	10	12.7%	6	15.0%	2	25.0%	33	12.7%
何らかの運動をほとんど毎日している。(時間無回答)																				
男性	0	0.0%	0	0.0%	0	0.0%	0	0.0%	0	0.0%	0	0.0%	0	0.0%	0	0.0%	0	0.0%	0	0.0%
女性	0	0.0%	0	0.0%	0	0.0%	0	0.0%	0	0.0%	0	0.0%	0	0.0%	0	0.0%	0	0.0%	0	0.0%
男女合計	0	0.0%	0	0.0%	0	0.0%	0	0.0%	0	0.0%	0	0.0%	0	0.0%	0	0.0%	0	0.0%	0	0.0%
何らかの運動を週2～4回程度、15分未満している。																				
男性	0	0.0%	0	0.0%	1	25.0%	0	0.0%	0	0.0%	0	0.0%	1	2.2%	1	4.8%	0	0.0%	3	2.3%
女性	0	0.0%	0	0.0%	0	0.0%	0	0.0%	0	0.0%	0	0.0%	3	8.8%	0	0.0%	0	0.0%	3	2.4%
男女合計	0	0.0%	0	0.0%	1	7.7%	0	0.0%	0	0.0%	0	0.0%	4	5.1%	1	2.5%	0	0.0%	6	2.3%
何らかの運動を週2～4回程度、15～30分未満している。																				
男性	0	0.0%	0	0.0%	0	0.0%	0	0.0%	0	0.0%	7	26.9%	2	4.4%	0	0.0%	1	33.3%	10	7.6%
女性	0	0.0%	1	20.0%	0	0.0%	0	0.0%	1	5.9%	3	16.7%	6	17.6%	2	10.5%	0	0.0%	13	10.2%
男女合計	0	0.0%	1	11.1%	0	0.0%	0	0.0%	1	2.8%	10	22.7%	8	10.1%	2	5.0%	1	12.5%	23	8.9%
何らかの運動を週2～4回程度、30分以上している。																				
男性	0	0.0%	0	0.0%	1	25.0%	2	25.0%	2	10.5%	4	15.4%	5	11.1%	7	33.3%	0	0.0%	21	15.9%
女性	0	0.0%	2	40.0%	1	11.1%	1	7.1%	1	5.9%	7	38.9%	6	17.6%	3	15.8%	0	0.0%	21	16.5%
男女合計	0	0.0%	2	22.2%	2	15.4%	3	13.6%	3	8.3%	11	25.0%	11	13.9%	10	25.0%	0	0.0%	42	16.2%
何らかの運動を週2～4回程度している。(時間無回答)																				
男性	0	0.0%	0	0.0%	0	0.0%	0	0.0%	0	0.0%	0	0.0%	0	0.0%	0	0.0%	0	0.0%	0	0.0%
女性	0	0.0%	0	0.0%	0	0.0%	0	0.0%	0	0.0%	0	0.0%	0	0.0%	0	0.0%	1	20.0%	1	0.8%
男女合計	0	0.0%	0	0.0%	0	0.0%	0	0.0%	0	0.0%	0	0.0%	0	0.0%	0	0.0%	1	12.5%	1	0.4%
何らかの運動を週1回程度、15分未満している。																				
男性	0	0.0%	0	0.0%	0	0.0%	0	0.0%	0	0.0%	0	0.0%	3	6.7%	0	0.0%	1	33.3%	4	3.0%
女性	1	16.7%	0	0.0%	0	0.0%	1	7.1%	0	0.0%	2	11.1%	0	0.0%	0	0.0%	0	0.0%	4	3.1%
男女合計	1	12.5%	0	0.0%	0	0.0%	1	4.5%	0	0.0%	2	4.5%	3	3.8%	0	0.0%	1	12.5%	8	3.1%
何らかの運動を週1回程度、15～30分未満している。																				
男性	0	0.0%	0	0.0%	1	25.0%	0	0.0%	1	5.3%	0	0.0%	1	2.2%	1	4.8%	0	0.0%	4	3.0%
女性	1	16.7%	0	0.0%	2	22.2%	0	0.0%	0	0.0%	1	5.6%	0	0.0%	1	5.3%	0	0.0%	5	3.9%
男女合計	1	12.5%	0	0.0%	3	23.1%	0	0.0%	1	2.8%	1	2.3%	1	1.3%	2	5.0%	0	0.0%	9	3.5%
何らかの運動を週1回程度、30分以上している。																				
男性	0	0.0%	1	25.0%	1	25.0%	0	0.0%	1	5.3%	3	11.5%	2	4.4%	1	4.8%	0	0.0%	9	6.8%
女性	0	0.0%	0	0.0%	0	0.0%	1	7.1%	1	5.9%	1	5.6%	2	5.9%	0	0.0%	0	0.0%	5	3.9%
男女合計	0	0.0%	1	11.1%	1	7.7%	1	4.5%	2	5.6%	4	9.1%	4	5.1%	1	2.5%	0	0.0%	14	5.4%
何らかの運動を週1回程度している。(時間無回答)																				
男性	0	0.0%	0	0.0%	0	0.0%	0	0.0%	0	0.0%	0	0.0%	0	0.0%	0	0.0%	0	0.0%	0	0.0%
女性	0	0.0%	0	0.0%	0	0.0%	0	0.0%	0	0.0%	0	0.0%	0	0.0%	0	0.0%	0	0.0%	0	0.0%
男女合計	0	0.0%	0	0.0%	0	0.0%	0	0.0%	0	0.0%	0	0.0%	0	0.0%	0	0.0%	0	0.0%	0	0.0%
ほとんど(まったく)していない。																				
男性	2	100.0%	3	75.0%	0	0.0%	4	50.0%	8	42.1%	8	30.8%	16	35.6%	6	28.6%	0	0.0%	47	35.6%
女性	4	66.7%	2	40.0%	4	44.4%	9	64.3%	7	41.2%	0	0.0%	11	32.4%	5	26.3%	2	40.0%	44	34.6%
男女合計	6	75.0%	5	55.6%	4	30.8%	13	59.1%	15	41.7%	8	18.2%	27	34.2%	11	27.5%	2	25.0%	91	35.1%
無回答																				
男性	0	0.0%	0	0.0%	0	0.0%	0	0.0%	0	0.0%	0	0.0%	3	6.7%	0	0.0%	0	0.0%	3	2.3%
女性	0	0.0%	0	0.0%	1	11.1%	1	7.1%	0	0.0%	0	0.0%	2	5.9%	0	0.0%	0	0.0%	4	3.1%
男女合計	0	0.0%	0	0.0%	1	7.7%	1	4.5%	0	0.0%	0	0.0%	5	6.3%	0	0.0%	0	0.0%	7	2.7%
全体(人)																				
男性	2		4		4		8		19		26		45		21		3		132	
女性	6		5		9		14		17		18		34		19		5		127	
男女合計	8		9		13		22		36		44		79		40		8		259	

○ 平成30年度健康ふくしま21調査（田村市、南相馬市、川俣町、広野町、富岡町、大熊町、浪江町）

	20	割合	30	割合	40	割合	50	割合	64	割合	69	割合	70	割合	80	割合	90	割合	全体数	割合
何らかの運動をほとんど毎日、15分未満している。																				
男性	0	0.0%	0	0.0%	0	0.0%	0	0.0%	0	0.0%	0	0.0%	0	0.0%	2	10.5%	0	0.0%	2	1.5%
女性	0	0.0%	0	0.0%	0	0.0%	0	0.0%	0	0.0%	3	11.5%	3	9.1%	1	5.0%	0	0.0%	7	4.5%
男女合計	0	0.0%	0	0.0%	0	0.0%	0	0.0%	0	0.0%	3	5.3%	3	4.8%	3	7.7%	0	0.0%	9	3.1%
何らかの運動をほとんど毎日、15～30分未満している。																				
男性	0	0.0%	0	0.0%	0	0.0%	1	7.7%	0	0.0%	1	3.2%	5	17.2%	4	21.1%	0	0.0%	11	8.1%
女性	0	0.0%	0	0.0%	0	0.0%	0	0.0%	0	0.0%	1	3.8%	1	3.0%	1	5.0%	1	14.3%	4	2.6%
男女合計	0	0.0%	0	0.0%	0	0.0%	1	2.5%	0	0.0%	2	3.5%	6	9.7%	5	12.8%	1	12.5%	15	5.2%
何らかの運動をほとんど毎日、30分以上している。																				
男性	0	0.0%	2	22.2%	1	8.3%	0	0.0%	4	28.6%	2	6.5%	2	6.9%	1	5.3%	0	0.0%	12	8.8%
女性	0	0.0%	0	0.0%	0	0.0%	0	0.0%	0	0.0%	3	11.5%	4	12.1%	0	0.0%	0	0.0%	7	4.5%
男女合計	0	0.0%	2	12.5%	1	4.5%	0	0.0%	4	12.5%	5	8.8%	6	9.7%	1	2.6%	0	0.0%	19	6.5%
何らかの運動をほとんど毎日している。（時間無回答）																				
男性	0	0.0%	0	0.0%	0	0.0%	0	0.0%	0	0.0%	0	0.0%	0	0.0%	0	0.0%	0	0.0%	0	0.0%
女性	0	0.0%	0	0.0%	0	0.0%	0	0.0%	0	0.0%	0	0.0%	0	0.0%	0	0.0%	0	0.0%	0	0.0%
男女合計	0	0.0%	0	0.0%	0	0.0%	0	0.0%	0	0.0%	0	0.0%	0	0.0%	0	0.0%	0	0.0%	0	0.0%
何らかの運動を週2～4回程度、15分未満している。																				
男性	0	0.0%	1	11.1%	0	0.0%	1	7.7%	0	0.0%	0	0.0%	1	3.4%	1	5.3%	0	0.0%	4	2.9%
女性	0	0.0%	0	0.0%	1	10.0%	2	7.4%	0	0.0%	1	3.8%	0	0.0%	2	10.0%	0	0.0%	6	3.9%
男女合計	0	0.0%	1	6.3%	1	4.5%	3	7.5%	0	0.0%	1	1.8%	1	1.6%	3	7.7%	0	0.0%	10	3.4%
何らかの運動を週2～4回程度、15～30分未満している。																				
男性	0	0.0%	0	0.0%	1	8.3%	0	0.0%	1	7.1%	3	9.7%	5	17.2%	2	10.5%	0	0.0%	12	8.8%
女性	1	14.3%	0	0.0%	0	0.0%	1	3.7%	1	5.6%	1	3.8%	6	18.2%	2	10.0%	0	0.0%	12	7.7%
男女合計	1	6.7%	0	0.0%	1	4.5%	1	2.5%	2	6.3%	4	7.0%	11	17.7%	4	10.3%	0	0.0%	24	8.2%
何らかの運動を週2～4回程度、30分以上している。																				
男性	1	12.5%	0	0.0%	2	16.7%	1	7.7%	3	21.4%	10	32.3%	2	6.9%	1	5.3%	0	0.0%	20	14.7%
女性	1	14.3%	0	0.0%	2	20.0%	3	11.1%	3	16.7%	4	15.4%	2	6.1%	2	10.0%	0	0.0%	17	11.0%
男女合計	2	13.3%	0	0.0%	4	18.2%	4	10.0%	6	18.8%	14	24.6%	4	6.5%	3	7.7%	0	0.0%	37	12.7%
何らかの運動を週2～4回程度している。（時間無回答）																				
男性	0	0.0%	0	0.0%	0	0.0%	0	0.0%	0	0.0%	0	0.0%	1	3.4%	0	0.0%	1	100.0%	2	1.5%
女性	0	0.0%	0	0.0%	0	0.0%	0	0.0%	0	0.0%	1	3.8%	1	3.0%	0	0.0%	0	0.0%	2	1.3%
男女合計	0	0.0%	0	0.0%	0	0.0%	0	0.0%	0	0.0%	1	1.8%	2	3.2%	0	0.0%	1	12.5%	4	1.4%
何らかの運動を週1回程度、15分未満している。																				
男性	0	0.0%	0	0.0%	1	8.3%	0	0.0%	1	7.1%	2	6.5%	1	3.4%	1	5.3%	0	0.0%	6	4.4%
女性	0	0.0%	1	14.3%	0	0.0%	2	7.4%	0	0.0%	0	0.0%	3	9.1%	0	0.0%	0	0.0%	6	3.9%
男女合計	0	0.0%	1	6.3%	1	4.5%	2	5.0%	1	3.1%	2	3.5%	4	6.5%	1	2.6%	0	0.0%	12	4.1%
何らかの運動を週1回程度、15～30分未満している。																				
男性	2	25.0%	0	0.0%	0	0.0%	3	23.1%	0	0.0%	0	0.0%	3	10.3%	0	0.0%	0	0.0%	8	5.9%
女性	0	0.0%	0	0.0%	1	10.0%	0	0.0%	1	5.6%	2	7.7%	0	0.0%	2	10.0%	0	0.0%	6	3.9%
男女合計	2	13.3%	0	0.0%	1	4.5%	3	7.5%	1	3.1%	2	3.5%	3	4.8%	2	5.1%	0	0.0%	14	4.8%
何らかの運動を週1回程度、30分以上している。																				
男性	2	25.0%	2	22.2%	2	16.7%	1	7.7%	0	0.0%	5	16.1%	2	6.9%	1	5.3%	0	0.0%	15	11.0%
女性	1	14.3%	0	0.0%	0	0.0%	4	14.8%	1	5.6%	2	7.7%	6	18.2%	4	20.0%	0	0.0%	18	11.6%
男女合計	3	20.0%	2	12.5%	2	9.1%	5	12.5%	1	3.1%	7	12.3%	8	12.9%	5	12.8%	0	0.0%	33	11.3%
何らかの運動を週1回程度している。（時間無回答）																				
男性	0	0.0%	0	0.0%	0	0.0%	0	0.0%	0	0.0%	0	0.0%	0	0.0%	0	0.0%	0	0.0%	0	0.0%
女性	0	0.0%	0	0.0%	0	0.0%	0	0.0%	0	0.0%	0	0.0%	0	0.0%	0	0.0%	0	0.0%	0	0.0%
男女合計	0	0.0%	0	0.0%	0	0.0%	0	0.0%	0	0.0%	0	0.0%	0	0.0%	0	0.0%	0	0.0%	0	0.0%
ほとんど（まったく）していない。																				
男性	3	37.5%	4	44.4%	3	25.0%	6	46.2%	5	35.7%	7	22.6%	7	24.1%	4	21.1%	0	0.0%	39	28.7%
女性	4	57.1%	6	85.7%	5	50.0%	15	55.6%	11	61.1%	8	30.8%	4	12.1%	5	25.0%	3	42.9%	61	39.4%
男女合計	7	46.7%	10	62.5%	8	36.4%	21	52.5%	16	50.0%	15	26.3%	11	17.7%	9	23.1%	3	37.5%	100	34.4%
無回答																				
男性	0	0.0%	0	0.0%	2	16.7%	0	0.0%	0	0.0%	1	3.2%	0	0.0%	2	10.5%	0	0.0%	5	3.7%
女性	0	0.0%	0	0.0%	1	10.0%	0	0.0%	1	5.6%	0	0.0%	3	9.1%	1	5.0%	3	42.9%	9	5.8%
男女合計	0	0.0%	0	0.0%	3	13.6%	0	0.0%	1	3.1%	1	1.8%	3	4.8%	3	7.7%	3	37.5%	14	4.8%
全体（人）																				
男性	8		9		12		13		14		31		29		19		1		136	
女性	7		7		10		27		18		26		33		20		7		155	
男女合計	15		16		22		40		32		57		62		39		8		291	

○ 平成21年度県民健康調査（田村市、南相馬市、富岡町、浪江町、葛尾村）

	20	割合	30	割合	40	割合	50	割合	64	割合	69	割合	70	割合	80	割合	90	割合	全体数	割合
何らかの運動をほとんど毎日、15分未満している。																				
男性	1	3.3%	0	0.0%	0	0.0%	2	3.0%	1	2.3%	2	7.1%	1	1.9%	1	6.7%	1	33.3%	9	3.1%
女性	0	0.0%	1	3.2%	0	0.0%	4	6.1%	1	2.8%	1	3.4%	6	12.2%	0	0.0%	0	0.0%	13	4.4%
男女合計	1	2.0%	1	1.6%	0	0.0%	6	4.5%	2	2.5%	3	5.3%	7	6.8%	1	2.1%	1	20.0%	22	3.8%
何らかの運動をほとんど毎日、15～30分未満している。																				
男性	0	0.0%	0	0.0%	0	0.0%	4	6.0%	2	4.7%	2	7.1%	4	7.4%	0	0.0%	0	0.0%	12	4.2%
女性	0	0.0%	0	0.0%	1	3.2%	3	4.5%	0	0.0%	2	6.9%	3	6.1%	2	6.1%	0	0.0%	11	3.7%
男女合計	0	0.0%	0	0.0%	1	2.3%	7	5.3%	2	2.5%	4	7.0%	7	6.8%	2	4.2%	0	0.0%	23	3.9%
何らかの運動をほとんど毎日、30分以上している。																				
男性	2	6.7%	1	3.0%	3	23.1%	3	4.5%	6	14.0%	4	14.3%	14	25.9%	3	20.0%	0	0.0%	36	12.6%
女性	0	0.0%	0	0.0%	1	3.2%	2	3.0%	6	16.7%	4	13.8%	4	8.2%	3	9.1%	0	0.0%	20	6.7%
男女合計	2	3.9%	1	1.6%	4	9.1%	5	3.8%	12	15.2%	8	14.0%	18	17.5%	6	12.5%	0	0.0%	56	9.6%
何らかの運動をほとんど毎日している。(時間無回答)																				
男性	0	0.0%	0	0.0%	0	0.0%	0	0.0%	1	2.3%	0	0.0%	0	0.0%	0	0.0%	0	0.0%	1	0.3%
女性	0	0.0%	0	0.0%	0	0.0%	0	0.0%	0	0.0%	0	0.0%	1	2.0%	0	0.0%	0	0.0%	1	0.3%
男女合計	0	0.0%	0	0.0%	0	0.0%	0	0.0%	1	1.3%	0	0.0%	1	1.0%	0	0.0%	0	0.0%	2	0.3%
何らかの運動を週2～4回程度、15分未満している。																				
男性	1	3.3%	1	3.0%	0	0.0%	0	0.0%	0	0.0%	0	0.0%	0	0.0%	0	0.0%	0	0.0%	2	0.7%
女性	0	0.0%	1	3.2%	1	3.2%	1	1.5%	1	2.8%	1	3.4%	2	4.1%	2	6.1%	0	0.0%	9	3.0%
男女合計	1	2.0%	2	3.1%	1	2.3%	1	0.8%	1	1.3%	1	1.8%	2	1.9%	2	4.2%	0	0.0%	11	1.9%
何らかの運動を週2～4回程度、15～30分未満している。																				
男性	1	3.3%	0	0.0%	1	7.7%	4	6.0%	2	4.7%	0	0.0%	2	3.7%	1	6.7%	0	0.0%	11	3.8%
女性	1	4.8%	1	3.2%	5	16.1%	7	10.6%	4	11.1%	1	3.4%	2	4.1%	0	0.0%	0	0.0%	21	7.0%
男女合計	2	3.9%	1	1.6%	6	13.6%	11	8.3%	6	7.6%	1	1.8%	4	3.9%	1	2.1%	0	0.0%	32	5.5%
何らかの運動を週2～4回程度、30分以上している。																				
男性	3	10.0%	3	9.1%	1	7.7%	7	10.4%	6	14.0%	4	14.3%	10	18.5%	3	20.0%	1	33.3%	38	13.3%
女性	1	4.8%	1	3.2%	3	9.7%	3	4.5%	8	22.2%	3	10.3%	5	10.2%	0	0.0%	0	0.0%	24	8.1%
男女合計	4	7.8%	4	6.3%	4	9.1%	10	7.5%	14	17.7%	7	12.3%	15	14.6%	3	6.3%	1	20.0%	62	10.6%
何らかの運動を週2～4回程度している。(時間無回答)																				
男性	0	0.0%	0	0.0%	0	0.0%	0	0.0%	0	0.0%	0	0.0%	0	0.0%	0	0.0%	0	0.0%	0	0.0%
女性	0	0.0%	0	0.0%	0	0.0%	0	0.0%	0	0.0%	0	0.0%	1	2.0%	1	3.0%	0	0.0%	2	0.7%
男女合計	0	0.0%	0	0.0%	0	0.0%	0	0.0%	0	0.0%	0	0.0%	1	1.0%	1	2.1%	0	0.0%	2	0.3%
何らかの運動を週1回程度、15分未満している。																				
男性	0	0.0%	0	0.0%	0	0.0%	1	1.5%	1	2.3%	2	7.1%	1	1.9%	0	0.0%	0	0.0%	5	1.7%
女性	1	4.8%	0	0.0%	2	6.5%	1	1.5%	0	0.0%	3	10.3%	2	4.1%	1	3.0%	0	0.0%	10	3.4%
男女合計	1	2.0%	0	0.0%	2	4.5%	2	1.5%	1	1.3%	5	8.8%	3	2.9%	1	2.1%	0	0.0%	15	2.6%
何らかの運動を週1回程度、15～30分未満している。																				
男性	3	10.0%	1	3.0%	0	0.0%	2	3.0%	3	7.0%	3	10.7%	1	1.9%	0	0.0%	0	0.0%	13	4.5%
女性	1	4.8%	1	3.2%	0	0.0%	4	6.1%	2	5.6%	0	0.0%	2	4.1%	1	3.0%	0	0.0%	11	3.7%
男女合計	4	7.8%	2	3.1%	0	0.0%	6	4.5%	5	6.3%	3	5.3%	3	2.9%	1	2.1%	0	0.0%	24	4.1%
何らかの運動を週1回程度、30分以上している。																				
男性	4	13.3%	7	21.2%	1	7.7%	4	6.0%	2	4.7%	3	10.7%	5	9.3%	0	0.0%	0	0.0%	26	9.1%
女性	0	0.0%	1	3.2%	1	3.2%	5	7.6%	2	5.6%	4	13.8%	1	2.0%	2	6.1%	0	0.0%	16	5.4%
男女合計	4	7.8%	8	12.5%	2	4.5%	9	6.8%	4	5.1%	7	12.3%	6	5.8%	2	4.2%	0	0.0%	42	7.2%
何らかの運動を週1回程度している。(時間無回答)																				
男性	0	0.0%	1	3.0%	0	0.0%	0	0.0%	0	0.0%	0	0.0%	1	1.9%	0	0.0%	0	0.0%	2	0.7%
女性	0	0.0%	0	0.0%	0	0.0%	1	1.5%	0	0.0%	0	0.0%	1	2.0%	0	0.0%	0	0.0%	2	0.7%
男女合計	0	0.0%	1	1.6%	0	0.0%	1	0.8%	0	0.0%	0	0.0%	2	1.9%	0	0.0%	0	0.0%	4	0.7%
ほとんど(まったく)していない。																				
男性	12	40.0%	18	54.5%	7	53.8%	39	58.2%	19	44.2%	8	28.6%	12	22.2%	5	33.3%	1	33.3%	121	42.3%
女性	16	76.2%	25	80.6%	16	51.6%	34	51.5%	11	30.6%	10	34.5%	14	28.6%	18	54.5%	2	100.0%	146	49.0%
男女合計	28	54.9%	43	67.2%	23	52.3%	73	54.9%	30	38.0%	18	31.6%	26	25.2%	23	47.9%	3	60.0%	267	45.7%
無回答																				
男性	3	10.0%	1	3.0%	0	0.0%	1	1.5%	0	0.0%	0	0.0%	3	5.6%	2	13.3%	0	0.0%	10	3.5%
女性	1	4.8%	0	0.0%	1	3.2%	1	1.5%	1	2.8%	0	0.0%	5	10.2%	3	9.1%	0	0.0%	12	4.0%
男女合計	4	7.8%	1	1.6%	1	2.3%	2	1.5%	1	1.3%	0	0.0%	8	7.8%	5	10.4%	0	0.0%	22	3.8%
全体(人)																				
男性	30		33		13		67		43		28		54		15		3		286	
女性	21		31		31		66		36		29		49		33		2		298	
男女合計	51		64		44		133		79		57		103		48		5		584	

3 飲酒の状況（満20歳以上対象）

(1) 飲酒の頻度

問15 あなたは、どのくらいお酒を飲んでいますか。（あてはまる番号1つに○）

- 1 毎日飲んでいる
- 2 週に5～6回飲んでいる
- 3 週に3～4回飲んでいる
- 4 たまに飲む程度
- 5 以前は飲んでいたが、今は飲んでいない
- 6 もともと飲まない

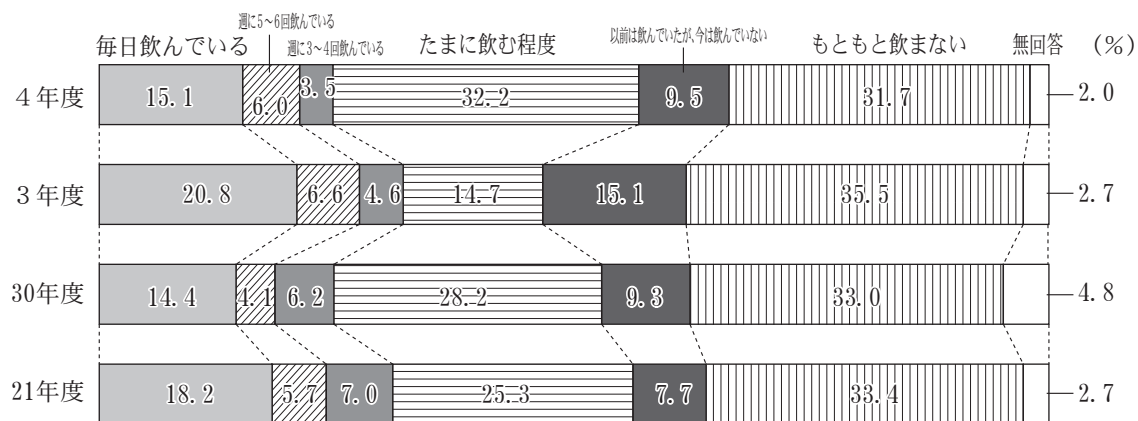

	R 4		R 3		H30		H21	
	人数(人)	割合(%)	人数(人)	割合(%)	人数(人)	割合(%)	人数(人)	割合(%)
1 と回答								
男性	27	26.7	46	34.8	32	23.5	91	31.8
女性	3	3.1	8	6.3	10	6.5	15	5.0
男女合計	30	15.1	54	20.8	42	14.4	106	18.2
2 と回答								
男性	8	7.9	15	11.4	6	4.4	26	9.1
女性	4	4.1	2	1.6	6	3.9	7	2.3
男女合計	12	6.0	17	6.6	12	4.1	33	5.7
3 と回答								
男性	6	5.9	8	6.1	13	9.6	30	10.5
女性	1	1.0	4	3.1	5	3.2	11	3.7
男女合計	7	3.5	12	4.6	18	6.2	41	7.0
4 と回答								
男性	31	30.7	18	13.6	37	27.2	67	23.4
女性	33	33.7	20	15.7	45	29.0	81	27.2
男女合計	64	32.2	38	14.7	82	28.2	148	25.3
5 と回答								
男性	11	10.9	23	17.4	16	11.8	23	8.0
女性	8	8.2	16	12.6	11	7.1	22	7.4
男女合計	19	9.5	39	15.1	27	9.3	45	7.7
6 と回答								
男性	17	16.8	19	14.4	28	20.6	42	14.7
女性	46	46.9	73	57.5	68	43.9	153	51.3
男女合計	63	31.7	92	35.5	96	33.0	195	33.4
無回答								
男性	1	1.0	3	2.3	4	2.9	7	2.4
女性	3	3.1	4	3.1	10	6.5	9	3.0
男女合計	4	2.0	7	2.7	14	4.8	16	2.7
全体(人)								
男性	101		132		136		286	
女性	98		127		155		298	
男女合計	199		259		291		584	

○ 令和4年度健康ふくしま21調査（田村市、南相馬市、川俣町、広野町、楡葉町）

	20	割合	30	割合	40	割合	50	割合	64	割合	69	割合	70～	割合	全体数	割合
1と回答																
男性	0	0.0%	0	0.0%	0	0.0%	5	27.8%	6	42.9%	7	46.7%	9	28.1%	27	26.7%
女性	0	0.0%	0	0.0%	0	0.0%	0	0.0%	1	14.3%	1	11.1%	1	2.9%	3	3.1%
男女合計	0	0.0%	0	0.0%	0	0.0%	5	12.8%	7	33.3%	8	33.3%	10	14.9%	30	15.1%
2と回答																
男性	0	0.0%	1	10.0%	1	12.5%	1	5.6%	2	14.3%	1	6.7%	2	6.3%	8	7.9%
女性	0	0.0%	0	0.0%	1	7.1%	0	0.0%	0	0.0%	1	11.1%	2	5.7%	4	4.1%
男女合計	0	0.0%	1	5.9%	2	9.1%	1	2.6%	2	9.5%	2	8.3%	4	6.0%	12	6.0%
3と回答																
男性	1	25.0%	1	10.0%	0	0.0%	2	11.1%	1	7.1%	0	0.0%	1	3.1%	6	5.9%
女性	0	0.0%	0	0.0%	1	7.1%	0	0.0%	0	0.0%	0	0.0%	0	0.0%	1	1.0%
男女合計	1	11.1%	1	5.9%	1	4.5%	2	5.1%	1	4.8%	0	0.0%	1	1.5%	7	3.5%
4と回答																
男性	3	75.0%	6	60.0%	3	37.5%	7	38.9%	2	14.3%	3	20.0%	7	21.9%	31	30.7%
女性	3	60.0%	4	57.1%	3	21.4%	9	42.9%	2	28.6%	3	33.3%	9	25.7%	33	33.7%
男女合計	6	66.7%	10	58.8%	6	27.3%	16	41.0%	4	19.0%	6	25.0%	16	23.9%	64	32.2%
5と回答																
男性	0	0.0%	1	10.0%	0	0.0%	1	5.6%	0	0.0%	2	13.3%	7	21.9%	11	10.9%
女性	2	40.0%	1	14.3%	0	0.0%	2	9.5%	1	14.3%	0	0.0%	2	5.7%	8	8.2%
男女合計	2	22.2%	2	11.8%	0	0.0%	3	7.7%	1	4.8%	2	8.3%	9	13.4%	19	9.5%
6と回答																
男性	0	0.0%	1	10.0%	4	50.0%	2	11.1%	3	21.4%	2	13.3%	5	15.6%	17	16.8%
女性	0	0.0%	2	28.6%	9	64.3%	10	47.6%	3	42.9%	4	44.4%	18	51.4%	46	46.9%
男女合計	0	0.0%	3	17.6%	13	59.1%	12	30.8%	6	28.6%	6	25.0%	23	34.3%	63	31.7%
無回答																
男性	0	0.0%	0	0.0%	0	0.0%	0	0.0%	0	0.0%	0	0.0%	1	3.1%	1	1.0%
女性	0	0.0%	0	0.0%	0	0.0%	0	0.0%	0	0.0%	0	0.0%	3	8.6%	3	3.1%
男女合計	0	0.0%	0	0.0%	0	0.0%	0	0.0%	0	0.0%	0	0.0%	4	6.0%	4	2.0%
全体(人)																
男性	4		10		8		18		14		15		32		101	
女性	5		7		14		21		7		9		35		98	
男女合計	9		17		22		39		21		24		67		199	

○ 令和3年度健康ふくしま21調査（南相馬市、川内村、浪江町、大熊町）

	20	割合	30	割合	40	割合	50	割合	64	割合	69	割合	70～	割合	全体数	割合
1と回答																
男性	0	0.0%	2	50.0%	2	50.0%	2	25.0%	8	42.1%	10	38.5%	22	31.9%	46	34.8%
女性	0	0.0%	2	40.0%	0	0.0%	2	14.3%	1	5.9%	2	11.1%	1	1.7%	8	6.3%
男女合計	0	0.0%	4	44.4%	2	15.4%	4	18.2%	9	25.0%	12	27.3%	23	18.1%	54	20.8%
2と回答																
男性	0	0.0%	1	25.0%	0	0.0%	1	12.5%	4	21.1%	3	11.5%	6	8.7%	15	11.4%
女性	0	0.0%	0	0.0%	0	0.0%	1	7.1%	0	0.0%	1	5.6%	0	0.0%	2	1.6%
男女合計	0	0.0%	1	11.1%	0	0.0%	2	9.1%	4	11.1%	4	9.1%	6	4.7%	17	6.6%
3と回答																
男性	1	50.0%	0	0.0%	0	0.0%	0	0.0%	1	5.3%	2	7.7%	4	5.8%	8	6.1%
女性	1	16.7%	0	0.0%	1	11.1%	0	0.0%	1	5.9%	0	0.0%	1	1.7%	4	3.1%
男女合計	2	25.0%	0	0.0%	1	7.7%	0	0.0%	2	5.6%	2	4.5%	5	3.9%	12	4.6%
4と回答																
男性	1	50.0%	0	0.0%	1	25.0%	0	0.0%	2	10.5%	6	23.1%	8	11.6%	18	13.6%
女性	1	16.7%	1	20.0%	2	22.2%	2	14.3%	4	23.5%	6	33.3%	4	6.9%	20	15.7%
男女合計	2	25.0%	1	11.1%	3	23.1%	2	9.1%	6	16.7%	12	27.3%	12	9.4%	38	14.7%
5と回答																
男性	0	0.0%	0	0.0%	0	0.0%	3	37.5%	0	0.0%	4	15.4%	16	23.2%	23	17.4%
女性	1	16.7%	1	20.0%	2	22.2%	2	14.3%	2	11.8%	2	11.1%	6	10.3%	16	12.6%
男女合計	1	12.5%	1	11.1%	2	15.4%	5	22.7%	2	5.6%	6	13.6%	22	17.3%	39	15.1%
6と回答																
男性	0	0.0%	1	25.0%	1	25.0%	2	25.0%	3	15.8%	1	3.8%	11	15.9%	19	14.4%
女性	3	50.0%	1	20.0%	4	44.4%	7	50.0%	9	52.9%	7	38.9%	42	72.4%	73	57.5%
男女合計	3	37.5%	2	22.2%	5	38.5%	9	40.9%	12	33.3%	8	18.2%	53	41.7%	92	35.5%
無回答																
男性	0	0.0%	0	0.0%	0	0.0%	0	0.0%	1	5.3%	0	0.0%	2	2.9%	3	2.3%
女性	0	0.0%	0	0.0%	0	0.0%	0	0.0%	0	0.0%	0	0.0%	4	6.9%	4	3.1%
男女合計	0	0.0%	0	0.0%	0	0.0%	0	0.0%	1	2.8%	0	0.0%	6	4.7%	7	2.7%
全体(人)																
男性	2		4		4		8		19		26		69		132	
女性	6		5		9		14		17		18		58		127	
男女合計	8		9		13		22		36		44		127		259	

○ 平成30年度健康ふくしま21調査（田村市、南相馬市、川俣町、広野町、富岡町、大熊町、浪江町）

	20	割合	30	割合	40	割合	50	割合	64	割合	69	割合	70～	割合	全体数	割合
1と回答																
男性	1	12.5%	0	0.0%	1	8.3%	4	30.8%	6	42.9%	10	32.3%	10	20.4%	32	23.5%
女性	0	0.0%	0	0.0%	2	20.0%	2	7.4%	1	5.6%	3	11.5%	2	3.3%	10	6.5%
男女合計	1	6.7%	0	0.0%	3	13.6%	6	15.0%	7	21.9%	13	22.8%	12	11.0%	42	14.4%
2と回答																
男性	0	0.0%	0	0.0%	0	0.0%	2	15.4%	0	0.0%	2	6.5%	2	4.1%	6	4.4%
女性	0	0.0%	0	0.0%	0	0.0%	3	11.1%	1	5.6%	1	3.8%	1	1.7%	6	3.9%
男女合計	0	0.0%	0	0.0%	0	0.0%	5	12.5%	1	3.1%	3	5.3%	3	2.8%	12	4.1%
3と回答																
男性	0	0.0%	4	44.4%	0	0.0%	2	15.4%	3	21.4%	3	9.7%	1	2.0%	13	9.6%
女性	0	0.0%	1	14.3%	0	0.0%	1	3.7%	1	5.6%	1	3.8%	1	1.7%	5	3.2%
男女合計	0	0.0%	5	31.3%	0	0.0%	3	7.5%	4	12.5%	4	7.0%	2	1.8%	18	6.2%
4と回答																
男性	5	62.5%	2	22.2%	8	66.7%	4	30.8%	4	28.6%	9	29.0%	5	10.2%	37	27.2%
女性	5	71.4%	2	28.6%	2	20.0%	10	37.0%	3	16.7%	10	38.5%	13	21.7%	45	29.0%
男女合計	10	66.7%	4	25.0%	10	45.5%	14	35.0%	7	21.9%	19	33.3%	18	16.5%	82	28.2%
5と回答																
男性	0	0.0%	0	0.0%	0	0.0%	0	0.0%	0	0.0%	3	9.7%	13	26.5%	16	11.8%
女性	1	14.3%	1	14.3%	1	10.0%	2	7.4%	3	16.7%	1	3.8%	2	3.3%	11	7.1%
男女合計	1	6.7%	1	6.3%	1	4.5%	2	5.0%	3	9.4%	4	7.0%	15	13.8%	27	9.3%
6と回答																
男性	2	25.0%	3	33.3%	1	8.3%	1	7.7%	1	7.1%	3	9.7%	17	34.7%	28	20.6%
女性	0	0.0%	3	42.9%	3	30.0%	9	33.3%	9	50.0%	10	38.5%	34	56.7%	68	43.9%
男女合計	2	13.3%	6	37.5%	4	18.2%	10	25.0%	10	31.3%	13	22.8%	51	46.8%	96	33.0%
無回答																
男性	0	0.0%	0	0.0%	2	16.7%	0	0.0%	0	0.0%	1	3.2%	1	2.0%	4	2.9%
女性	1	14.3%	0	0.0%	2	20.0%	0	0.0%	0	0.0%	0	0.0%	7	11.7%	10	6.5%
男女合計	1	6.7%	0	0.0%	4	18.2%	0	0.0%	0	0.0%	1	1.8%	8	7.3%	14	4.8%
全体(人)																
男性	8		9		12		13		14		31		49		136	
女性	7		7		10		27		18		26		60		155	
男女合計	15		16		22		40		32		57		109		291	

○ 平成21年度県民健康調査（田村市、南相馬市、富岡町、浪江町、葛尾村）

	20	割合	30	割合	40	割合	50	割合	64	割合	69	割合	70～	割合	全体数	割合
1と回答																
男性	3	10.0%	9	27.3%	7	53.8%	24	35.8%	16	37.2%	11	39.3%	21	29.2%	91	31.8%
女性	1	4.8%	2	6.5%	2	6.5%	3	4.5%	3	8.3%	3	10.3%	1	1.2%	15	5.0%
男女合計	4	7.8%	11	17.2%	9	20.5%	27	20.3%	19	24.1%	14	24.6%	22	14.1%	106	18.2%
2と回答																
男性	2	6.7%	3	9.1%	1	7.7%	4	6.0%	4	9.3%	1	3.6%	11	15.3%	26	9.1%
女性	0	0.0%	1	3.2%	2	6.5%	3	4.5%	0	0.0%	0	0.0%	1	1.2%	7	2.3%
男女合計	2	3.9%	4	6.3%	3	6.8%	7	5.3%	4	5.1%	1	1.8%	12	7.7%	33	5.7%
3と回答																
男性	7	23.3%	5	15.2%	0	0.0%	8	11.9%	2	4.7%	4	14.3%	4	5.6%	30	10.5%
女性	0	0.0%	2	6.5%	2	6.5%	3	4.5%	0	0.0%	1	3.4%	3	3.6%	11	3.7%
男女合計	7	13.7%	7	10.9%	2	4.5%	11	8.3%	2	2.5%	5	8.8%	7	4.5%	41	7.0%
4と回答																
男性	17	56.7%	8	24.2%	3	23.1%	12	17.9%	11	25.6%	4	14.3%	12	16.7%	67	23.4%
女性	12	57.1%	14	45.2%	11	35.5%	23	34.8%	7	19.4%	5	17.2%	9	10.7%	81	27.2%
男女合計	29	56.9%	22	34.4%	14	31.8%	35	26.3%	18	22.8%	9	15.8%	21	13.5%	148	25.3%
5と回答																
男性	0	0.0%	1	3.0%	0	0.0%	5	7.5%	2	4.7%	4	14.3%	11	15.3%	23	8.0%
女性	1	4.8%	6	19.4%	3	9.7%	3	4.5%	0	0.0%	4	13.8%	5	6.0%	22	7.4%
男女合計	1	2.0%	7	10.9%	3	6.8%	8	6.0%	2	2.5%	8	14.0%	16	10.3%	45	7.7%
6と回答																
男性	1	3.3%	5	15.2%	2	15.4%	12	17.9%	8	18.6%	3	10.7%	11	15.3%	42	14.7%
女性	7	33.3%	6	19.4%	11	35.5%	29	43.9%	25	69.4%	15	51.7%	60	71.4%	153	51.3%
男女合計	8	15.7%	11	17.2%	13	29.5%	41	30.8%	33	41.8%	18	31.6%	71	45.5%	195	33.4%
無回答																
男性	0	0.0%	2	6.1%	0	0.0%	2	3.0%	0	0.0%	1	3.6%	2	2.8%	7	2.4%
女性	0	0.0%	0	0.0%	0	0.0%	2	3.0%	1	2.8%	1	3.4%	5	6.0%	9	3.0%
男女合計	0	0.0%	2	3.1%	0	0.0%	4	3.0%	1	1.3%	2	3.5%	7	4.5%	16	2.7%
全体(人)																
男性	30		33		13		67		43		28		72		286	
女性	21		31		31		66		36		29		84		298	
男女合計	51		64		44		133		79		57		156		584	

(2) 飲酒の量

付問 問15で1～4を選んだ方におたずねします。あなたが1回に飲む量はどれくらいですか。日本酒にあてはめて計算し、あてはまる番号を1つ選んで○をつけてください。(計算の仕方は、下記のとおりです。)

1 極少量 2 1合程度 3 2合程度 4 3合以上

日本酒1合あたりのアルコール量は以下と同等
 ・焼酎(25度、100ml)
 ・ビール中瓶1本(500ml)
 ・ウィスキーダブル1杯(60ml)
 ・ワイングラス2杯(200ml)
 うすめて飲むときは、もとの量で計算してください。

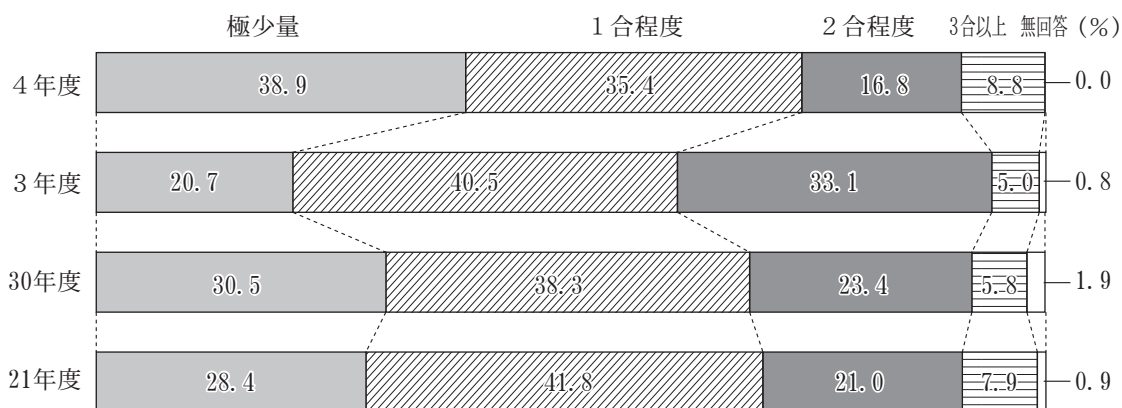

	R 4		R 3		H30		H21	
	人数(人)	割合(%)	人数(人)	割合(%)	人数(人)	割合(%)	人数(人)	割合(%)
1と回答								
男性	17	23.6	11	12.6	13	14.8	34	15.9
女性	27	65.9	14	41.2	34	51.5	59	51.8
男女合計	44	38.9	25	20.7	47	30.5	93	28.4
2と回答								
男性	31	43.1	32	36.8	35	39.8	95	44.4
女性	9	22.0	17	50.0	24	36.4	42	36.8
男女合計	40	35.4	49	40.5	59	38.3	137	41.8
3と回答								
男性	14	19.4	37	42.5	30	34.1	56	26.2
女性	5	12.2	3	8.8	6	9.1	13	11.4
男女合計	19	16.8	40	33.1	36	23.4	69	21.0
4と回答								
男性	10	13.9	6	6.9	7	8.0	26	12.1
女性	0	0.0	0	0.0	2	3.0	0	0.0
男女合計	10	8.8	6	5.0	9	5.8	26	7.9
無回答								
男性	0	0.0	1	1.1	3	3.4	3	1.4
女性	0	0.0	0	0.0	0	0.0	0	0.0
男女合計	0	0.0	1	0.8	3	1.9	3	0.9
全体(人)								
男性	72		87		88		214	
女性	41		34		66		114	
男女合計	113		121		154		328	

○ 令和4年度健康ふくしま21調査（田村市、南相馬市、川俣町、広野町、楡葉町）

	20	割合	30	割合	40	割合	50	割合	64	割合	69	割合	70～	割合	全体数	割合
1と回答																
男性	1	25.0%	3	37.5%	2	50.0%	5	33.3%	1	9.1%	1	9.1%	4	21.1%	17	23.6%
女性	2	66.7%	2	50.0%	3	60.0%	7	77.8%	1	33.3%	2	40.0%	10	83.3%	27	65.9%
男女合計	3	42.9%	5	41.7%	5	55.6%	12	50.0%	2	14.3%	3	18.8%	14	45.2%	44	38.9%
2と回答																
男性	3	75.0%	4	50.0%	2	50.0%	3	20.0%	3	27.3%	4	36.4%	12	63.2%	31	43.1%
女性	1	33.3%	1	25.0%	1	20.0%	1	11.1%	2	66.7%	1	20.0%	2	16.7%	9	22.0%
男女合計	4	57.1%	5	41.7%	3	33.3%	4	16.7%	5	35.7%	5	31.3%	14	45.2%	40	35.4%
3と回答																
男性	0	0.0%	1	12.5%	0	0.0%	3	20.0%	5	45.5%	2	18.2%	3	15.8%	14	19.4%
女性	0	0.0%	1	25.0%	1	20.0%	1	11.1%	0	0.0%	2	40.0%	0	0.0%	5	12.2%
男女合計	0	0.0%	2	16.7%	1	11.1%	4	16.7%	5	35.7%	4	25.0%	3	9.7%	19	16.8%
4と回答																
男性	0	0.0%	0	0.0%	0	0.0%	4	26.7%	2	18.2%	4	36.4%	0	0.0%	10	13.9%
女性	0	0.0%	0	0.0%	0	0.0%	0	0.0%	0	0.0%	0	0.0%	0	0.0%	0	0.0%
男女合計	0	0.0%	0	0.0%	0	0.0%	4	16.7%	2	14.3%	4	25.0%	0	0.0%	10	8.8%
無回答																
男性	0	0.0%	0	0.0%	0	0.0%	0	0.0%	0	0.0%	0	0.0%	0	0.0%	0	0.0%
女性	0	0.0%	0	0.0%	0	0.0%	0	0.0%	0	0.0%	0	0.0%	0	0.0%	0	0.0%
男女合計	0	0.0%	0	0.0%	0	0.0%	0	0.0%	0	0.0%	0	0.0%	0	0.0%	0	0.0%
全体(人)																
男性	4		8		4		15		11		11		19		72	
女性	3		4		5		9		3		5		12		41	
男女合計	7		12		9		24		14		16		31		113	

○ 令和3年度健康ふくしま21調査（南相馬市、川内村、浪江町、大熊町）

	20	割合	30	割合	40	割合	50	割合	64	割合	69	割合	70～	割合	全体数	割合
1と回答																
男性	1	50.0%	0	0.0%	0	0.0%	0	0.0%	1	6.7%	3	14.3%	6	15.0%	11	12.6%
女性	0	0.0%	1	33.3%	1	33.3%	1	20.0%	1	16.7%	6	66.7%	4	66.7%	14	41.2%
男女合計	1	25.0%	1	16.7%	1	16.7%	1	12.5%	2	9.5%	9	30.0%	10	21.7%	25	20.7%
2と回答																
男性	1	50.0%	1	33.3%	1	33.3%	0	0.0%	7	46.7%	7	33.3%	15	37.5%	32	36.8%
女性	1	50.0%	1	33.3%	2	66.7%	3	60.0%	5	83.3%	3	33.3%	2	33.3%	17	50.0%
男女合計	2	50.0%	2	33.3%	3	50.0%	3	37.5%	12	57.1%	10	33.3%	17	37.0%	49	40.5%
3と回答																
男性	0	0.0%	2	66.7%	2	66.7%	2	66.7%	6	40.0%	8	38.1%	17	42.5%	37	42.5%
女性	1	50.0%	1	33.3%	0	0.0%	1	20.0%	0	0.0%	0	0.0%	0	0.0%	3	8.8%
男女合計	1	25.0%	3	50.0%	2	33.3%	3	37.5%	6	28.6%	8	26.7%	17	37.0%	40	33.1%
4と回答																
男性	0	0.0%	0	0.0%	0	0.0%	1	33.3%	1	6.7%	3	14.3%	1	2.5%	6	6.9%
女性	0	0.0%	0	0.0%	0	0.0%	0	0.0%	0	0.0%	0	0.0%	0	0.0%	0	0.0%
男女合計	0	0.0%	0	0.0%	0	0.0%	1	12.5%	1	4.8%	3	10.0%	1	2.2%	6	5.0%
無回答																
男性	0	0.0%	0	0.0%	0	0.0%	0	0.0%	0	0.0%	0	0.0%	1	2.5%	1	1.1%
女性	0	0.0%	0	0.0%	0	0.0%	0	0.0%	0	0.0%	0	0.0%	0	0.0%	0	0.0%
男女合計	0	0.0%	0	0.0%	0	0.0%	0	0.0%	0	0.0%	0	0.0%	1	2.2%	1	0.8%
全体(人)																
男性	2		3		3		3		15		21		40		87	
女性	2		3		3		5		6		9		6		34	
男女合計	4		6		6		8		21		30		46		121	

○ 平成30年度健康ふくしま21調査（田村市、南相馬市、川俣町、広野町、富岡町、大熊町、浪江町）

	20	割合	30	割合	40	割合	50	割合	64	割合	69	割合	70～	割合	全体数	割合
1と回答																
男性	1	16.7%	0	0.0%	1	11.1%	2	16.7%	1	7.7%	4	16.7%	4	22.2%	13	14.8%
女性	2	40.0%	1	33.3%	1	25.0%	6	37.5%	3	50.0%	8	53.3%	13	76.5%	34	51.5%
男女合計	3	27.3%	1	11.1%	2	15.4%	8	28.6%	4	21.1%	12	30.8%	17	48.6%	47	30.5%
2と回答																
男性	2	33.3%	4	66.7%	3	33.3%	4	33.3%	5	38.5%	9	37.5%	8	44.4%	35	39.8%
女性	3	60.0%	1	33.3%	3	75.0%	8	50.0%	2	33.3%	4	26.7%	3	17.6%	24	36.4%
男女合計	5	45.5%	5	55.6%	6	46.2%	12	42.9%	7	36.8%	13	33.3%	11	31.4%	59	38.3%
3と回答																
男性	2	33.3%	2	33.3%	1	11.1%	6	50.0%	6	46.2%	8	33.3%	5	27.8%	30	34.1%
女性	0	0.0%	0	0.0%	0	0.0%	2	12.5%	1	16.7%	2	13.3%	1	5.9%	6	9.1%
男女合計	2	18.2%	2	22.2%	1	7.7%	8	28.6%	7	36.8%	10	25.6%	6	17.1%	36	23.4%
4と回答																
男性	1	16.7%	0	0.0%	3	33.3%	0	0.0%	0	0.0%	3	12.5%	0	0.0%	7	8.0%
女性	0	0.0%	1	33.3%	0	0.0%	0	0.0%	0	0.0%	1	6.7%	0	0.0%	2	3.0%
男女合計	1	9.1%	1	11.1%	3	23.1%	0	0.0%	0	0.0%	4	10.3%	0	0.0%	9	5.8%
無回答																
男性	0	0.0%	0	0.0%	1	11.1%	0	0.0%	1	7.7%	0	0.0%	1	5.6%	3	3.4%
女性	0	0.0%	0	0.0%	0	0.0%	0	0.0%	0	0.0%	0	0.0%	0	0.0%	0	0.0%
男女合計	0	0.0%	0	0.0%	1	7.7%	0	0.0%	1	5.3%	0	0.0%	1	2.9%	3	1.9%
全体(人)																
男性	6		6		9		12		13		24		18		88	
女性	5		3		4		16		6		15		17		66	
男女合計	11		9		13		28		19		39		35		154	

○ 平成21年度県民健康調査（田村市、南相馬市、富岡町、浪江町、葛尾村）

	20	割合	30	割合	40	割合	50	割合	64	割合	69	割合	70～	割合	全体数	割合
1と回答																
男性	4	13.8%	4	16.0%	1	9.1%	5	10.4%	4	12.1%	5	25.0%	11	22.9%	34	15.9%
女性	8	61.5%	4	21.1%	8	47.1%	17	53.1%	7	70.0%	6	66.7%	9	64.3%	59	51.8%
男女合計	12	28.6%	8	18.2%	9	32.1%	22	27.5%	11	25.6%	11	37.9%	20	32.3%	93	28.4%
2と回答																
男性	14	48.3%	13	52.0%	3	27.3%	21	43.8%	12	36.4%	8	40.0%	24	50.0%	95	44.4%
女性	4	30.8%	12	63.2%	6	35.3%	12	37.5%	2	20.0%	2	22.2%	4	28.6%	42	36.8%
男女合計	18	42.9%	25	56.8%	9	32.1%	33	41.3%	14	32.6%	10	34.5%	28	45.2%	137	41.8%
3と回答																
男性	4	13.8%	4	16.0%	5	45.5%	14	29.2%	9	27.3%	7	35.0%	13	27.1%	56	26.2%
女性	1	7.7%	3	15.8%	3	17.6%	3	9.4%	1	10.0%	1	11.1%	1	7.1%	13	11.4%
男女合計	5	11.9%	7	15.9%	8	28.6%	17	21.3%	10	23.3%	8	27.6%	14	22.6%	69	21.0%
4と回答																
男性	6	20.7%	2	8.0%	2	18.2%	8	16.7%	8	24.2%	0	0.0%	0	0.0%	26	12.1%
女性	0	0.0%	0	0.0%	0	0.0%	0	0.0%	0	0.0%	0	0.0%	0	0.0%	0	0.0%
男女合計	6	14.3%	2	4.5%	2	7.1%	8	10.0%	8	18.6%	0	0.0%	0	0.0%	26	7.9%
無回答																
男性	1	3.4%	2	8.0%	0	0.0%	0	0.0%	0	0.0%	0	0.0%	0	0.0%	3	1.4%
女性	0	0.0%	0	0.0%	0	0.0%	0	0.0%	0	0.0%	0	0.0%	0	0.0%	0	0.0%
男女合計	1	2.4%	2	4.5%	0	0.0%	0	0.0%	0	0.0%	0	0.0%	0	0.0%	3	0.9%
全体(人)																
男性	29		25		11		48		33		20		48		214	
女性	13		19		17		32		10		9		14		114	
男女合計	42		44		28		80		43		29		62		328	

(3) 飲酒の状況（満20歳以上対象）

「(1)飲酒の頻度」及び「(2)飲酒の量」の回答に関するクロス集計）

○ 令和4年度健康ふくしま21調査（田村市、南相馬市、川俣町、広野町、楡葉町）

	20	割合	30	割合	40	割合	50	割合	64	割合	69	割合	70	割合	80	割合	90	割合	全体数	割合
毎日、極少量お酒を飲んでいる。																				
男性	0	0.0%	0	0.0%	0	0.0%	1	5.6%	0	0.0%	0	0.0%	0	0.0%	1	25.0%	0	0.0%	2	2.0%
女性	0	0.0%	0	0.0%	0	0.0%	0	0.0%	0	0.0%	0	0.0%	0	0.0%	0	0.0%	0	0.0%	0	0.0%
男女合計	0	0.0%	0	0.0%	0	0.0%	1	2.6%	0	0.0%	0	0.0%	0	0.0%	1	5.9%	0	0.0%	2	1.0%
毎日、1程度お酒を飲んでいる。																				
男性	0	0.0%	0	0.0%	0	0.0%	1	5.6%	2	14.3%	1	6.7%	4	16.0%	1	25.0%	0	0.0%	9	8.9%
女性	0	0.0%	0	0.0%	0	0.0%	0	0.0%	1	14.3%	0	0.0%	1	5.6%	0	0.0%	0	0.0%	2	2.0%
男女合計	0	0.0%	0	0.0%	0	0.0%	1	2.6%	3	14.3%	1	4.2%	5	11.6%	1	5.9%	0	0.0%	11	5.5%
毎日、2程度お酒を飲んでいる。																				
男性	0	0.0%	0	0.0%	0	0.0%	1	5.6%	2	14.3%	2	13.3%	3	12.0%	0	0.0%	0	0.0%	8	7.9%
女性	0	0.0%	0	0.0%	0	0.0%	0	0.0%	0	0.0%	1	11.1%	0	0.0%	0	0.0%	0	0.0%	1	1.0%
男女合計	0	0.0%	0	0.0%	0	0.0%	1	2.6%	2	9.5%	3	12.5%	3	7.0%	0	0.0%	0	0.0%	9	4.5%
毎日、3以上お酒を飲んでいる。																				
男性	0	0.0%	0	0.0%	0	0.0%	2	11.1%	2	14.3%	4	26.7%	0	0.0%	0	0.0%	0	0.0%	8	7.9%
女性	0	0.0%	0	0.0%	0	0.0%	0	0.0%	0	0.0%	0	0.0%	0	0.0%	0	0.0%	0	0.0%	0	0.0%
男女合計	0	0.0%	0	0.0%	0	0.0%	2	5.1%	2	9.5%	4	16.7%	0	0.0%	0	0.0%	0	0.0%	8	4.0%
毎日、お酒を飲んでいる。（飲む量未回答）																				
男性	0	0.0%	0	0.0%	0	0.0%	0	0.0%	0	0.0%	0	0.0%	0	0.0%	0	0.0%	0	0.0%	0	0.0%
女性	0	0.0%	0	0.0%	0	0.0%	0	0.0%	0	0.0%	0	0.0%	0	0.0%	0	0.0%	0	0.0%	0	0.0%
男女合計	0	0.0%	0	0.0%	0	0.0%	0	0.0%	0	0.0%	0	0.0%	0	0.0%	0	0.0%	0	0.0%	0	0.0%
週に5、6回、極少量お酒を飲んでいる。																				
男性	0	0.0%	0	0.0%	0	0.0%	0	0.0%	0	0.0%	0	0.0%	0	0.0%	0	0.0%	0	0.0%	0	0.0%
女性	0	0.0%	0	0.0%	0	0.0%	0	0.0%	0	0.0%	0	0.0%	2	11.1%	0	0.0%	0	0.0%	2	2.0%
男女合計	0	0.0%	0	0.0%	0	0.0%	0	0.0%	0	0.0%	0	0.0%	2	4.7%	0	0.0%	0	0.0%	2	1.0%
週に5、6回、1程度お酒を飲んでいる。																				
男性	0	0.0%	1	10.0%	1	12.5%	1	5.6%	1	7.1%	1	6.7%	2	8.0%	0	0.0%	0	0.0%	7	6.9%
女性	0	0.0%	0	0.0%	1	7.1%	0	0.0%	0	0.0%	0	0.0%	0	0.0%	0	0.0%	0	0.0%	1	1.0%
男女合計	0	0.0%	1	5.9%	2	9.1%	1	2.6%	1	4.8%	1	4.2%	2	4.7%	0	0.0%	0	0.0%	8	4.0%
週に5、6回、2程度お酒を飲んでいる。																				
男性	0	0.0%	0	0.0%	0	0.0%	0	0.0%	1	7.1%	0	0.0%	0	0.0%	0	0.0%	0	0.0%	1	1.0%
女性	0	0.0%	0	0.0%	0	0.0%	0	0.0%	0	0.0%	1	11.1%	0	0.0%	0	0.0%	0	0.0%	1	1.0%
男女合計	0	0.0%	0	0.0%	0	0.0%	0	0.0%	1	4.8%	1	4.2%	0	0.0%	0	0.0%	0	0.0%	2	1.0%
週に5、6回、3以上お酒を飲んでいる。																				
男性	0	0.0%	0	0.0%	0	0.0%	0	0.0%	0	0.0%	0	0.0%	0	0.0%	0	0.0%	0	0.0%	0	0.0%
女性	0	0.0%	0	0.0%	0	0.0%	0	0.0%	0	0.0%	0	0.0%	0	0.0%	0	0.0%	0	0.0%	0	0.0%
男女合計	0	0.0%	0	0.0%	0	0.0%	0	0.0%	0	0.0%	0	0.0%	0	0.0%	0	0.0%	0	0.0%	0	0.0%
週に5、6回、お酒を飲んでいる。（飲む量未回答）																				
男性	0	0.0%	0	0.0%	0	0.0%	0	0.0%	0	0.0%	0	0.0%	0	0.0%	0	0.0%	0	0.0%	0	0.0%
女性	0	0.0%	0	0.0%	0	0.0%	0	0.0%	0	0.0%	0	0.0%	0	0.0%	0	0.0%	0	0.0%	0	0.0%
男女合計	0	0.0%	0	0.0%	0	0.0%	0	0.0%	0	0.0%	0	0.0%	0	0.0%	0	0.0%	0	0.0%	0	0.0%
週に3、4回、極少量お酒を飲んでいる。																				
男性	0	0.0%	0	0.0%	0	0.0%	0	0.0%	0	0.0%	0	0.0%	0	0.0%	0	0.0%	0	0.0%	0	0.0%
女性	0	0.0%	0	0.0%	0	0.0%	0	0.0%	0	0.0%	0	0.0%	0	0.0%	0	0.0%	0	0.0%	0	0.0%
男女合計	0	0.0%	0	0.0%	0	0.0%	0	0.0%	0	0.0%	0	0.0%	0	0.0%	0	0.0%	0	0.0%	0	0.0%
週に3、4回、1程度お酒を飲んでいる。																				
男性	1	25.0%	1	10.0%	0	0.0%	0	0.0%	0	0.0%	0	0.0%	1	4.0%	0	0.0%	0	0.0%	3	3.0%
女性	0	0.0%	0	0.0%	0	0.0%	0	0.0%	0	0.0%	0	0.0%	0	0.0%	0	0.0%	0	0.0%	0	0.0%
男女合計	1	11.1%	1	5.9%	0	0.0%	0	0.0%	0	0.0%	0	0.0%	1	2.3%	0	0.0%	0	0.0%	3	1.5%
週に3、4回、2程度お酒を飲んでいる。																				
男性	0	0.0%	0	0.0%	0	0.0%	1	5.6%	1	7.1%	0	0.0%	0	0.0%	0	0.0%	0	0.0%	2	2.0%
女性	0	0.0%	0	0.0%	1	7.1%	0	0.0%	0	0.0%	0	0.0%	0	0.0%	0	0.0%	0	0.0%	1	1.0%
男女合計	0	0.0%	0	0.0%	1	4.5%	1	2.6%	1	4.8%	0	0.0%	0	0.0%	0	0.0%	0	0.0%	3	1.5%
週に3、4回、3以上お酒を飲んでいる。																				
男性	0	0.0%	0	0.0%	0	0.0%	1	5.6%	0	0.0%	0	0.0%	0	0.0%	0	0.0%	0	0.0%	1	1.0%
女性	0	0.0%	0	0.0%	0	0.0%	0	0.0%	0	0.0%	0	0.0%	0	0.0%	0	0.0%	0	0.0%	0	0.0%
男女合計	0	0.0%	0	0.0%	0	0.0%	1	2.6%	0	0.0%	0	0.0%	0	0.0%	0	0.0%	0	0.0%	1	0.5%

	20	割合	30	割合	40	割合	50	割合	64	割合	69	割合	70	割合	80	割合	90	割合	全体数	割合
週に3、4回、お酒を飲んでいる。(飲む量未回答)																				
男性	0	0.0%	0	0.0%	0	0.0%	0	0.0%	0	0.0%	0	0.0%	0	0.0%	0	0.0%	0	0.0%	0	0.0%
女性	0	0.0%	0	0.0%	0	0.0%	0	0.0%	0	0.0%	0	0.0%	0	0.0%	0	0.0%	0	0.0%	0	0.0%
男女合計	0	0.0%	0	0.0%	0	0.0%	0	0.0%	0	0.0%	0	0.0%	0	0.0%	0	0.0%	0	0.0%	0	0.0%
たまに、極少量お酒を飲んでいる。																				
男性	1	25.0%	3	30.0%	2	25.0%	4	22.2%	1	7.1%	1	6.7%	2	8.0%	0	0.0%	1	33.3%	15	14.9%
女性	2	40.0%	2	28.6%	3	21.4%	7	33.3%	1	14.3%	2	22.2%	4	22.2%	3	23.1%	1	25.0%	25	25.5%
男女合計	3	33.3%	5	29.4%	5	22.7%	11	28.2%	2	9.5%	3	12.5%	6	14.0%	3	17.6%	2	28.6%	40	20.1%
たまに、1合程度お酒を飲んでいる。																				
男性	2	50.0%	2	20.0%	1	12.5%	1	5.6%	0	0.0%	2	13.3%	2	8.0%	2	50.0%	0	0.0%	12	11.9%
女性	1	20.0%	1	14.3%	0	0.0%	1	4.8%	1	14.3%	1	11.1%	1	5.6%	0	0.0%	0	0.0%	6	6.1%
男女合計	3	33.3%	3	17.6%	1	4.5%	2	5.1%	1	4.8%	3	12.5%	3	7.0%	2	11.8%	0	0.0%	18	9.0%
たまに、2合程度お酒を飲んでいる。																				
男性	0	0.0%	1	10.0%	0	0.0%	1	5.6%	1	7.1%	0	0.0%	0	0.0%	0	0.0%	0	0.0%	3	3.0%
女性	0	0.0%	1	14.3%	0	0.0%	1	4.8%	0	0.0%	0	0.0%	0	0.0%	0	0.0%	0	0.0%	2	2.0%
男女合計	0	0.0%	2	11.8%	0	0.0%	2	5.1%	1	4.8%	0	0.0%	0	0.0%	0	0.0%	0	0.0%	5	2.5%
たまに、3合以上お酒を飲んでいる。																				
男性	0	0.0%	0	0.0%	0	0.0%	1	5.6%	0	0.0%	0	0.0%	0	0.0%	0	0.0%	0	0.0%	1	1.0%
女性	0	0.0%	0	0.0%	0	0.0%	0	0.0%	0	0.0%	0	0.0%	0	0.0%	0	0.0%	0	0.0%	0	0.0%
男女合計	0	0.0%	0	0.0%	0	0.0%	1	2.6%	0	0.0%	0	0.0%	0	0.0%	0	0.0%	0	0.0%	1	0.5%
たまに、お酒を飲んでいる。(飲む量未回答)																				
男性	0	0.0%	0	0.0%	0	0.0%	0	0.0%	0	0.0%	0	0.0%	0	0.0%	0	0.0%	0	0.0%	0	0.0%
女性	0	0.0%	0	0.0%	0	0.0%	0	0.0%	0	0.0%	0	0.0%	0	0.0%	0	0.0%	0	0.0%	0	0.0%
男女合計	0	0.0%	0	0.0%	0	0.0%	0	0.0%	0	0.0%	0	0.0%	0	0.0%	0	0.0%	0	0.0%	0	0.0%
*参考 以前は飲んでいましたが、今は飲んでいない。																				
男性	0	0.0%	1	10.0%	0	0.0%	1	5.6%	0	0.0%	2	13.3%	6	24.0%	0	0.0%	1	33.3%	11	10.9%
女性	2	40.0%	1	14.3%	0	0.0%	2	9.5%	1	14.3%	0	0.0%	0	0.0%	0	0.0%	2	50.0%	8	8.2%
男女合計	2	22.2%	2	11.8%	0	0.0%	3	7.7%	1	4.8%	2	8.3%	6	14.0%	0	0.0%	3	42.9%	19	9.5%
*参考 もともと飲まない。																				
男性	0	0.0%	1	10.0%	4	50.0%	2	11.1%	3	21.4%	2	13.3%	4	16.0%	0	0.0%	1	33.3%	17	16.8%
女性	0	0.0%	2	28.6%	9	64.3%	10	47.6%	3	42.9%	4	44.4%	8	44.4%	9	69.2%	1	25.0%	46	46.9%
男女合計	0	0.0%	3	17.6%	13	59.1%	12	30.8%	6	28.6%	6	25.0%	12	27.9%	9	52.9%	2	28.6%	63	31.7%
無回答																				
男性	0	0.0%	0	0.0%	0	0.0%	0	0.0%	0	0.0%	0	0.0%	1	4.0%	0	0.0%	0	0.0%	1	1.0%
女性	0	0.0%	0	0.0%	0	0.0%	0	0.0%	0	0.0%	0	0.0%	2	11.1%	1	7.7%	0	0.0%	3	3.1%
男女合計	0	0.0%	0	0.0%	0	0.0%	0	0.0%	0	0.0%	0	0.0%	3	7.0%	1	5.9%	0	0.0%	4	2.0%
全体(人)																				
男性	4		10		8		18		14		15		25		4		3		101	
女性	5		7		14		21		7		9		18		13		4		98	
男女合計	9		17		22		39		21		24		43		17		7		199	

○ 令和3年度健康ふくしま21調査（南相馬市、川内村、浪江町、大熊町）

	20	割合	30	割合	40	割合	50	割合	64	割合	69	割合	70	割合	80	割合	90	割合	全体数	割合
毎日、極少量お酒を飲んでいる。																				
男性	0	0.0%	0	0.0%	0	0.0%	0	0.0%	0	0.0%	1	3.8%	1	2.2%	1	4.8%	0	0.0%	3	2.3%
女性	0	0.0%	1	20.0%	0	0.0%	1	7.1%	0	0.0%	0	0.0%	0	0.0%	0	0.0%	0	0.0%	2	1.6%
男女合計	0	0.0%	1	11.1%	0	0.0%	1	4.5%	0	0.0%	1	2.3%	1	1.3%	1	2.5%	0	0.0%	5	1.9%
毎日、1合程度お酒を飲んでいる。																				
男性	0	0.0%	0	0.0%	1	25.0%	0	0.0%	3	15.8%	3	11.5%	6	13.3%	3	14.3%	0	0.0%	16	12.1%
女性	0	0.0%	0	0.0%	0	0.0%	0	0.0%	1	5.9%	2	11.1%	1	2.9%	0	0.0%	0	0.0%	4	3.1%
男女合計	0	0.0%	0	0.0%	1	7.7%	0	0.0%	4	11.1%	5	11.4%	7	8.9%	3	7.5%	0	0.0%	20	7.7%
毎日、2合程度お酒を飲んでいる。																				
男性	0	0.0%	2	50.0%	1	25.0%	2	25.0%	5	26.3%	4	15.4%	10	22.2%	1	4.8%	0	0.0%	25	18.9%
女性	0	0.0%	1	20.0%	0	0.0%	1	7.1%	0	0.0%	0	0.0%	0	0.0%	0	0.0%	0	0.0%	2	1.6%
男女合計	0	0.0%	3	33.3%	1	7.7%	3	13.6%	5	13.9%	4	9.1%	10	12.7%	1	2.5%	0	0.0%	27	10.4%
毎日、3合以上お酒を飲んでいる。																				
男性	0	0.0%	0	0.0%	0	0.0%	0	0.0%	0	0.0%	2	7.7%	0	0.0%	0	0.0%	0	0.0%	2	1.5%
女性	0	0.0%	0	0.0%	0	0.0%	0	0.0%	0	0.0%	0	0.0%	0	0.0%	0	0.0%	0	0.0%	0	0.0%
男女合計	0	0.0%	0	0.0%	0	0.0%	0	0.0%	0	0.0%	2	4.5%	0	0.0%	0	0.0%	0	0.0%	2	0.8%
毎日、お酒を飲んでいる。（飲む量未回答）																				
男性	0	0.0%	0	0.0%	0	0.0%	0	0.0%	0	0.0%	0	0.0%	0	0.0%	0	0.0%	0	0.0%	0	0.0%
女性	0	0.0%	0	0.0%	0	0.0%	0	0.0%	0	0.0%	0	0.0%	0	0.0%	0	0.0%	0	0.0%	0	0.0%
男女合計	0	0.0%	0	0.0%	0	0.0%	0	0.0%	0	0.0%	0	0.0%	0	0.0%	0	0.0%	0	0.0%	0	0.0%
週に5、6回、極少量お酒を飲んでいる。																				
男性	0	0.0%	0	0.0%	0	0.0%	0	0.0%	0	0.0%	0	0.0%	0	0.0%	2	9.5%	0	0.0%	2	1.5%
女性	0	0.0%	0	0.0%	0	0.0%	0	0.0%	0	0.0%	1	5.6%	0	0.0%	0	0.0%	0	0.0%	1	0.8%
男女合計	0	0.0%	0	0.0%	0	0.0%	0	0.0%	0	0.0%	1	2.3%	0	0.0%	2	5.0%	0	0.0%	3	1.2%
週に5、6回、1合程度お酒を飲んでいる。																				
男性	0	0.0%	1	25.0%	0	0.0%	0	0.0%	2	10.5%	1	3.8%	0	0.0%	1	4.8%	0	0.0%	5	3.8%
女性	0	0.0%	0	0.0%	0	0.0%	1	7.1%	0	0.0%	0	0.0%	0	0.0%	0	0.0%	0	0.0%	1	0.8%
男女合計	0	0.0%	1	11.1%	0	0.0%	1	4.5%	2	5.6%	1	2.3%	0	0.0%	1	2.5%	0	0.0%	6	2.3%
週に5、6回、2合程度お酒を飲んでいる。																				
男性	0	0.0%	0	0.0%	0	0.0%	0	0.0%	1	5.3%	2	7.7%	2	4.4%	0	0.0%	0	0.0%	5	3.8%
女性	0	0.0%	0	0.0%	0	0.0%	0	0.0%	0	0.0%	0	0.0%	0	0.0%	0	0.0%	0	0.0%	0	0.0%
男女合計	0	0.0%	0	0.0%	0	0.0%	0	0.0%	1	2.8%	2	4.5%	2	2.5%	0	0.0%	0	0.0%	5	1.9%
週に5、6回、3合以上お酒を飲んでいる。																				
男性	0	0.0%	0	0.0%	0	0.0%	1	12.5%	1	5.3%	0	0.0%	1	2.2%	0	0.0%	0	0.0%	3	2.3%
女性	0	0.0%	0	0.0%	0	0.0%	0	0.0%	0	0.0%	0	0.0%	0	0.0%	0	0.0%	0	0.0%	0	0.0%
男女合計	0	0.0%	0	0.0%	0	0.0%	1	4.5%	1	2.8%	0	0.0%	1	1.3%	0	0.0%	0	0.0%	3	1.2%
週に5、6回、お酒を飲んでいる。（飲む量未回答）																				
男性	0	0.0%	0	0.0%	0	0.0%	0	0.0%	0	0.0%	0	0.0%	0	0.0%	0	0.0%	0	0.0%	0	0.0%
女性	0	0.0%	0	0.0%	0	0.0%	0	0.0%	0	0.0%	0	0.0%	0	0.0%	0	0.0%	0	0.0%	0	0.0%
男女合計	0	0.0%	0	0.0%	0	0.0%	0	0.0%	0	0.0%	0	0.0%	0	0.0%	0	0.0%	0	0.0%	0	0.0%
週に3、4回、極少量お酒を飲んでいる。																				
男性	0	0.0%	0	0.0%	0	0.0%	0	0.0%	0	0.0%	0	0.0%	0	0.0%	0	0.0%	0	0.0%	0	0.0%
女性	0	0.0%	0	0.0%	0	0.0%	0	0.0%	0	0.0%	0	0.0%	0	0.0%	0	0.0%	0	0.0%	0	0.0%
男女合計	0	0.0%	0	0.0%	0	0.0%	0	0.0%	0	0.0%	0	0.0%	0	0.0%	0	0.0%	0	0.0%	0	0.0%
週に3、4回、1合程度お酒を飲んでいる。																				
男性	1	50.0%	0	0.0%	0	0.0%	0	0.0%	1	5.3%	0	0.0%	0	0.0%	1	4.8%	0	0.0%	3	2.3%
女性	1	16.7%	0	0.0%	1	11.1%	0	0.0%	1	5.9%	0	0.0%	1	2.9%	0	0.0%	0	0.0%	4	3.1%
男女合計	2	25.0%	0	0.0%	1	7.7%	0	0.0%	2	5.6%	0	0.0%	1	1.3%	1	2.5%	0	0.0%	7	2.7%
週に3、4回、2合程度お酒を飲んでいる。																				
男性	0	0.0%	0	0.0%	0	0.0%	0	0.0%	0	0.0%	1	3.8%	3	6.7%	0	0.0%	0	0.0%	4	3.0%
女性	0	0.0%	0	0.0%	0	0.0%	0	0.0%	0	0.0%	0	0.0%	0	0.0%	0	0.0%	0	0.0%	0	0.0%
男女合計	0	0.0%	0	0.0%	0	0.0%	0	0.0%	0	0.0%	1	2.3%	3	3.8%	0	0.0%	0	0.0%	4	1.5%
週に3、4回、3合以上お酒を飲んでいる。																				
男性	0	0.0%	0	0.0%	0	0.0%	0	0.0%	0	0.0%	1	3.8%	0	0.0%	0	0.0%	0	0.0%	1	0.8%
女性	0	0.0%	0	0.0%	0	0.0%	0	0.0%	0	0.0%	0	0.0%	0	0.0%	0	0.0%	0	0.0%	0	0.0%
男女合計	0	0.0%	0	0.0%	0	0.0%	0	0.0%	0	0.0%	1	2.3%	0	0.0%	0	0.0%	0	0.0%	1	0.4%
週に3、4回、お酒を飲んでいる。（飲む量未回答）																				
男性	0	0.0%	0	0.0%	0	0.0%	0	0.0%	0	0.0%	0	0.0%	0	0.0%	0	0.0%	0	0.0%	0	0.0%
女性	0	0.0%	0	0.0%	0	0.0%	0	0.0%	0	0.0%	0	0.0%	0	0.0%	0	0.0%	0	0.0%	0	0.0%
男女合計	0	0.0%	0	0.0%	0	0.0%	0	0.0%	0	0.0%	0	0.0%	0	0.0%	0	0.0%	0	0.0%	0	0.0%

	20	割合	30	割合	40	割合	50	割合	64	割合	69	割合	70	割合	80	割合	90	割合	全体数	割合		
たまたに、極少量お酒を飲んでいる。																						
男性	1	50.0%	0	0.0%	0	0.0%	0	0.0%	1	5.3%	2	7.7%	1	2.2%	1	4.8%	0	0.0%	6	4.5%		
女性	0	0.0%	0	0.0%	1	11.1%	0	0.0%	1	5.9%	5	27.8%	3	8.8%	1	5.3%	0	0.0%	11	8.7%		
男女合計	1	12.5%	0	0.0%	1	7.7%	0	0.0%	2	5.6%	7	15.9%	4	5.1%	2	5.0%	0	0.0%	17	6.6%		
たまたに、1 合程度お酒を飲んでいる。																						
男性	0	0.0%	0	0.0%	0	0.0%	0	0.0%	1	5.3%	3	11.5%	3	6.7%	1	4.8%	0	0.0%	8	6.1%		
女性	0	0.0%	1	20.0%	1	11.1%	2	14.3%	3	17.6%	1	5.6%	0	0.0%	0	0.0%	0	0.0%	8	6.3%		
男女合計	0	0.0%	1	11.1%	1	7.7%	2	9.1%	4	11.1%	4	9.1%	3	3.8%	1	2.5%	0	0.0%	16	6.2%		
たまたに、2 合程度お酒を飲んでいる。																						
男性	0	0.0%	0	0.0%	1	25.0%	0	0.0%	0	0.0%	1	3.8%	1	2.2%	0	0.0%	0	0.0%	3	2.3%		
女性	1	16.7%	0	0.0%	0	0.0%	0	0.0%	0	0.0%	0	0.0%	0	0.0%	0	0.0%	0	0.0%	1	0.8%		
男女合計	1	12.5%	0	0.0%	1	7.7%	0	0.0%	0	0.0%	1	2.3%	1	1.3%	0	0.0%	0	0.0%	4	1.5%		
たまたに、3 合以上お酒を飲んでいる。																						
男性	0	0.0%	0	0.0%	0	0.0%	0	0.0%	0	0.0%	0	0.0%	0	0.0%	0	0.0%	0	0.0%	0	0.0%		
女性	0	0.0%	0	0.0%	0	0.0%	0	0.0%	0	0.0%	0	0.0%	0	0.0%	0	0.0%	0	0.0%	0	0.0%		
男女合計	0	0.0%	0	0.0%	0	0.0%	0	0.0%	0	0.0%	0	0.0%	0	0.0%	0	0.0%	0	0.0%	0	0.0%		
たまたに、お酒を飲んでいる。(飲む量未回答)																						
男性	0	0.0%	0	0.0%	0	0.0%	0	0.0%	0	0.0%	0	0.0%	0	0.0%	1	4.8%	0	0.0%	1	0.8%		
女性	0	0.0%	0	0.0%	0	0.0%	0	0.0%	0	0.0%	0	0.0%	0	0.0%	0	0.0%	0	0.0%	0	0.0%		
男女合計	0	0.0%	0	0.0%	0	0.0%	0	0.0%	0	0.0%	0	0.0%	0	0.0%	1	2.5%	0	0.0%	1	0.4%		
*参考 以前は飲んでいたが、今は飲んでいない。																						
男性	0	0.0%	0	0.0%	0	0.0%	3	37.5%	0	0.0%	4	15.4%	11	24.4%	4	19.0%	1	33.3%	23	17.4%		
女性	1	16.7%	1	20.0%	2	22.2%	2	14.3%	2	11.8%	2	11.1%	3	8.8%	1	5.3%	2	40.0%	16	12.6%		
男女合計	1	12.5%	1	11.1%	2	15.4%	5	22.7%	2	5.6%	6	13.6%	14	17.7%	5	12.5%	3	37.5%	39	15.1%		
*参考 もともと飲まない。																						
男性	0	0.0%	1	25.0%	1	25.0%	2	25.0%	3	15.8%	1	3.8%	6	13.3%	4	19.0%	1	33.3%	19	14.4%		
女性	3	50.0%	1	20.0%	4	44.4%	7	50.0%	9	52.9%	7	38.9%	24	70.6%	16	84.2%	2	40.0%	73	57.5%		
男女合計	3	37.5%	2	22.2%	5	38.5%	9	40.9%	12	33.3%	8	18.2%	30	38.0%	20	50.0%	3	37.5%	92	35.5%		
無回答																						
男性	0	0.0%	0	0.0%	0	0.0%	0	0.0%	1	5.3%	0	0.0%	0	0.0%	1	4.8%	1	33.3%	3	2.3%		
女性	0	0.0%	0	0.0%	0	0.0%	0	0.0%	0	0.0%	0	0.0%	2	5.9%	1	5.3%	1	20.0%	4	3.1%		
男女合計	0	0.0%	0	0.0%	0	0.0%	0	0.0%	1	2.8%	0	0.0%	2	2.5%	2	5.0%	2	25.0%	7	2.7%		
全体(人)																						
男性	2		4		4		8		19		26		45		21		3		132			
女性	6		5		9		14		17		18		34		19		5		127			
男女合計	8		9		13		22		36		44		79		40		8		259			

○ 平成30年度健康ふくしま21調査（田村市、南相馬市、川俣町、広野町、富岡町、大熊町、浪江町）

	20	割合	30	割合	40	割合	50	割合	64	割合	69	割合	70	割合	80	割合	90	割合	全体数	割合
毎日、極少量お酒を飲んでいる。																				
男性	0	0.0%	0	0.0%	0	0.0%	0	0.0%	0	0.0%	0	0.0%	0	0.0%	1	5.3%	0	0.0%	1	0.7%
女性	0	0.0%	0	0.0%	0	0.0%	1	3.7%	1	5.6%	0	0.0%	1	3.0%	1	5.0%	0	0.0%	4	2.6%
男女合計	0	0.0%	0	0.0%	0	0.0%	1	2.5%	1	3.1%	0	0.0%	1	1.6%	2	5.1%	0	0.0%	5	1.7%
毎日、1合程度お酒を飲んでいる。																				
男性	0	0.0%	0	0.0%	1	8.3%	0	0.0%	3	21.4%	3	9.7%	3	10.3%	2	10.5%	0	0.0%	12	8.8%
女性	0	0.0%	0	0.0%	2	20.0%	1	3.7%	0	0.0%	1	3.8%	0	0.0%	0	0.0%	0	0.0%	4	2.6%
男女合計	0	0.0%	0	0.0%	3	13.6%	1	2.5%	3	9.4%	4	7.0%	3	4.8%	2	5.1%	0	0.0%	16	5.5%
毎日、2合程度お酒を飲んでいる。																				
男性	1	12.5%	0	0.0%	0	0.0%	4	30.8%	3	21.4%	6	19.4%	3	10.3%	1	5.3%	0	0.0%	18	13.2%
女性	0	0.0%	0	0.0%	0	0.0%	0	0.0%	0	0.0%	1	3.8%	0	0.0%	0	0.0%	0	0.0%	1	0.6%
男女合計	1	6.7%	0	0.0%	0	0.0%	4	10.0%	3	9.4%	7	12.3%	3	4.8%	1	2.6%	0	0.0%	19	6.5%
毎日、3合以上お酒を飲んでいる。																				
男性	0	0.0%	0	0.0%	0	0.0%	0	0.0%	0	0.0%	1	3.2%	0	0.0%	0	0.0%	0	0.0%	1	0.7%
女性	0	0.0%	0	0.0%	0	0.0%	0	0.0%	0	0.0%	1	3.8%	0	0.0%	0	0.0%	0	0.0%	1	0.6%
男女合計	0	0.0%	0	0.0%	0	0.0%	0	0.0%	0	0.0%	2	3.5%	0	0.0%	0	0.0%	0	0.0%	2	0.7%
毎日、お酒を飲んでいる。（飲む量未回答）																				
男性	0	0.0%	0	0.0%	0	0.0%	0	0.0%	0	0.0%	0	0.0%	0	0.0%	0	0.0%	0	0.0%	0	0.0%
女性	0	0.0%	0	0.0%	0	0.0%	0	0.0%	0	0.0%	0	0.0%	0	0.0%	0	0.0%	0	0.0%	0	0.0%
男女合計	0	0.0%	0	0.0%	0	0.0%	0	0.0%	0	0.0%	0	0.0%	0	0.0%	0	0.0%	0	0.0%	0	0.0%
週に5、6回、極少量お酒を飲んでいる。																				
男性	0	0.0%	0	0.0%	0	0.0%	0	0.0%	0	0.0%	0	0.0%	0	0.0%	0	0.0%	0	0.0%	0	0.0%
女性	0	0.0%	0	0.0%	0	0.0%	0	0.0%	0	0.0%	0	0.0%	0	0.0%	0	0.0%	0	0.0%	0	0.0%
男女合計	0	0.0%	0	0.0%	0	0.0%	0	0.0%	0	0.0%	0	0.0%	0	0.0%	0	0.0%	0	0.0%	0	0.0%
週に5、6回、1合程度お酒を飲んでいる。																				
男性	0	0.0%	0	0.0%	0	0.0%	1	7.7%	0	0.0%	0	0.0%	1	3.4%	0	0.0%	0	0.0%	2	1.5%
女性	0	0.0%	0	0.0%	0	0.0%	2	7.4%	1	5.6%	1	3.8%	1	3.0%	0	0.0%	0	0.0%	5	3.2%
男女合計	0	0.0%	0	0.0%	0	0.0%	3	7.5%	1	3.1%	1	1.8%	2	3.2%	0	0.0%	0	0.0%	7	2.4%
週に5、6回、2合程度お酒を飲んでいる。																				
男性	0	0.0%	0	0.0%	0	0.0%	1	7.7%	0	0.0%	1	3.2%	1	3.4%	0	0.0%	0	0.0%	3	2.2%
女性	0	0.0%	0	0.0%	0	0.0%	1	3.7%	0	0.0%	0	0.0%	0	0.0%	0	0.0%	0	0.0%	1	0.6%
男女合計	0	0.0%	0	0.0%	0	0.0%	2	5.0%	0	0.0%	1	1.8%	1	1.6%	0	0.0%	0	0.0%	4	1.4%
週に5、6回、3合以上お酒を飲んでいる。																				
男性	0	0.0%	0	0.0%	0	0.0%	0	0.0%	0	0.0%	1	3.2%	0	0.0%	0	0.0%	0	0.0%	1	0.7%
女性	0	0.0%	0	0.0%	0	0.0%	0	0.0%	0	0.0%	0	0.0%	0	0.0%	0	0.0%	0	0.0%	0	0.0%
男女合計	0	0.0%	0	0.0%	0	0.0%	0	0.0%	0	0.0%	1	1.8%	0	0.0%	0	0.0%	0	0.0%	1	0.3%
週に5、6回、お酒を飲んでいる。（飲む量未回答）																				
男性	0	0.0%	0	0.0%	0	0.0%	0	0.0%	0	0.0%	0	0.0%	0	0.0%	0	0.0%	0	0.0%	0	0.0%
女性	0	0.0%	0	0.0%	0	0.0%	0	0.0%	0	0.0%	0	0.0%	0	0.0%	0	0.0%	0	0.0%	0	0.0%
男女合計	0	0.0%	0	0.0%	0	0.0%	0	0.0%	0	0.0%	0	0.0%	0	0.0%	0	0.0%	0	0.0%	0	0.0%
週に3、4回、極少量お酒を飲んでいる。																				
男性	0	0.0%	0	0.0%	0	0.0%	0	0.0%	0	0.0%	0	0.0%	0	0.0%	0	0.0%	0	0.0%	0	0.0%
女性	0	0.0%	0	0.0%	0	0.0%	0	0.0%	0	0.0%	1	3.8%	0	0.0%	0	0.0%	0	0.0%	1	0.6%
男女合計	0	0.0%	0	0.0%	0	0.0%	0	0.0%	0	0.0%	1	1.8%	0	0.0%	0	0.0%	0	0.0%	1	0.3%
週に3、4回、1合程度お酒を飲んでいる。																				
男性	0	0.0%	2	22.2%	0	0.0%	1	7.7%	1	7.1%	2	6.5%	0	0.0%	1	5.3%	0	0.0%	7	5.1%
女性	0	0.0%	1	14.3%	0	0.0%	1	3.7%	1	5.6%	0	0.0%	0	0.0%	0	0.0%	0	0.0%	3	1.9%
男女合計	0	0.0%	3	18.8%	0	0.0%	2	5.0%	2	6.3%	2	3.5%	0	0.0%	1	2.6%	0	0.0%	10	3.4%
週に3、4回、2合程度お酒を飲んでいる。																				
男性	0	0.0%	2	22.2%	0	0.0%	1	7.7%	2	14.3%	0	0.0%	0	0.0%	0	0.0%	0	0.0%	5	3.7%
女性	0	0.0%	0	0.0%	0	0.0%	0	0.0%	0	0.0%	0	0.0%	0	0.0%	1	5.0%	0	0.0%	1	0.6%
男女合計	0	0.0%	2	12.5%	0	0.0%	1	2.5%	2	6.3%	0	0.0%	0	0.0%	1	2.6%	0	0.0%	6	2.1%
週に3、4回、3合以上お酒を飲んでいる。																				
男性	0	0.0%	0	0.0%	0	0.0%	0	0.0%	0	0.0%	1	3.2%	0	0.0%	0	0.0%	0	0.0%	1	0.7%
女性	0	0.0%	0	0.0%	0	0.0%	0	0.0%	0	0.0%	0	0.0%	0	0.0%	0	0.0%	0	0.0%	0	0.0%
男女合計	0	0.0%	0	0.0%	0	0.0%	0	0.0%	0	0.0%	1	1.8%	0	0.0%	0	0.0%	0	0.0%	1	0.3%
週に3、4回、お酒を飲んでいる。（飲む量未回答）																				
男性	0	0.0%	0	0.0%	0	0.0%	0	0.0%	0	0.0%	0	0.0%	0	0.0%	0	0.0%	0	0.0%	0	0.0%
女性	0	0.0%	0	0.0%	0	0.0%	0	0.0%	0	0.0%	0	0.0%	0	0.0%	0	0.0%	0	0.0%	0	0.0%
男女合計	0	0.0%	0	0.0%	0	0.0%	0	0.0%	0	0.0%	0	0.0%	0	0.0%	0	0.0%	0	0.0%	0	0.0%

	20	割合	30	割合	40	割合	50	割合	64	割合	69	割合	70	割合	80	割合	90	割合	全体数	割合		
たまに、極少量お酒を飲んでいる。																						
男性	1	12.5%	0	0.0%	1	8.3%	2	15.4%	1	7.1%	4	12.9%	2	6.9%	1	5.3%	0	0.0%	12	8.8%		
女性	2	28.6%	1	14.3%	1	10.0%	5	18.5%	2	11.1%	7	26.9%	7	21.2%	4	20.0%	0	0.0%	29	18.7%		
男女合計	3	20.0%	1	6.3%	2	9.1%	7	17.5%	3	9.4%	11	19.3%	9	14.5%	5	12.8%	0	0.0%	41	14.1%		
たまに、1 合程度お酒を飲んでいる。																						
男性	2	25.0%	2	22.2%	2	16.7%	2	15.4%	1	7.1%	4	12.9%	1	3.4%	0	0.0%	0	0.0%	14	10.3%		
女性	3	42.9%	0	0.0%	1	10.0%	4	14.8%	0	0.0%	2	7.7%	2	6.1%	0	0.0%	0	0.0%	12	7.7%		
男女合計	5	33.3%	2	12.5%	3	13.6%	6	15.0%	1	3.1%	6	10.5%	3	4.8%	0	0.0%	0	0.0%	26	8.9%		
たまに、2 合程度お酒を飲んでいる。																						
男性	1	12.5%	0	0.0%	1	8.3%	0	0.0%	1	7.1%	1	3.2%	0	0.0%	0	0.0%	0	0.0%	4	2.9%		
女性	0	0.0%	0	0.0%	0	0.0%	1	3.7%	1	5.6%	1	3.8%	0	0.0%	0	0.0%	0	0.0%	3	1.9%		
男女合計	1	6.7%	0	0.0%	1	4.5%	1	2.5%	2	6.3%	2	3.5%	0	0.0%	0	0.0%	0	0.0%	7	2.4%		
たまに、3 合以上お酒を飲んでいる。																						
男性	1	12.5%	0	0.0%	3	25.0%	0	0.0%	0	0.0%	0	0.0%	0	0.0%	0	0.0%	0	0.0%	4	2.9%		
女性	0	0.0%	1	14.3%	0	0.0%	0	0.0%	0	0.0%	0	0.0%	0	0.0%	0	0.0%	0	0.0%	1	0.6%		
男女合計	1	6.7%	1	6.3%	3	13.6%	0	0.0%	0	0.0%	0	0.0%	0	0.0%	0	0.0%	0	0.0%	5	1.7%		
たまに、お酒を飲んでいる。(飲む量未回答)																						
男性	0	0.0%	0	0.0%	1	8.3%	0	0.0%	1	7.1%	0	0.0%	1	3.4%	0	0.0%	0	0.0%	3	2.2%		
女性	0	0.0%	0	0.0%	0	0.0%	0	0.0%	0	0.0%	0	0.0%	0	0.0%	0	0.0%	0	0.0%	0	0.0%		
男女合計	0	0.0%	0	0.0%	1	4.5%	0	0.0%	1	3.1%	0	0.0%	1	1.6%	0	0.0%	0	0.0%	3	1.0%		
*参考 以前は飲んでいたが、今は飲んでいない。																						
男性	0	0.0%	0	0.0%	0	0.0%	0	0.0%	0	0.0%	3	9.7%	9	31.0%	4	21.1%	0	0.0%	16	11.8%		
女性	1	14.3%	1	14.3%	1	10.0%	2	7.4%	3	16.7%	1	3.8%	2	6.1%	0	0.0%	0	0.0%	11	7.1%		
男女合計	1	6.7%	1	6.3%	1	4.5%	2	5.0%	3	9.4%	4	7.0%	11	17.7%	4	10.3%	0	0.0%	27	9.3%		
*参考 もともと飲まない。																						
男性	2	25.0%	3	33.3%	1	8.3%	1	7.7%	1	7.1%	3	9.7%	8	27.6%	8	42.1%	1	100.0%	28	20.6%		
女性	0	0.0%	3	42.9%	3	30.0%	9	33.3%	9	50.0%	10	38.5%	16	48.5%	13	65.0%	5	71.4%	68	43.9%		
男女合計	2	13.3%	6	37.5%	4	18.2%	10	25.0%	10	31.3%	13	22.8%	24	38.7%	21	53.8%	6	75.0%	96	33.0%		
無回答																						
男性	0	0.0%	0	0.0%	2	16.7%	0	0.0%	0	0.0%	1	3.2%	0	0.0%	1	5.3%	0	0.0%	4	2.9%		
女性	1	14.3%	0	0.0%	2	20.0%	0	0.0%	0	0.0%	0	0.0%	4	12.1%	1	5.0%	2	28.6%	10	6.5%		
男女合計	1	6.7%	0	0.0%	4	18.2%	0	0.0%	0	0.0%	1	1.8%	4	6.5%	2	5.1%	2	25.0%	14	4.8%		
全体(人)																						
男性	8		9		12		13		14		31		29		19		1		136			
女性	7		7		10		27		18		26		33		20		7		155			
男女合計	15		16		22		40		32		57		62		39		8		291			

○ 平成21年度県民健康調査（田村市、南相馬市、富岡町、浪江町、葛尾村）

	20	割合	30	割合	40	割合	50	割合	64	割合	69	割合	70	割合	80	割合	90	割合	全体数	割合
毎日、極少量お酒を飲んでいる。																				
男性	0	0.0%	0	0.0%	0	0.0%	1	1.5%	0	0.0%	1	3.6%	2	3.7%	1	6.7%	0	0.0%	5	1.7%
女性	0	0.0%	0	0.0%	0	0.0%	0	0.0%	1	2.8%	1	3.4%	0	0.0%	0	0.0%	0	0.0%	2	0.7%
男女合計	0	0.0%	0	0.0%	0	0.0%	1	0.8%	1	1.3%	2	3.5%	2	1.9%	1	2.1%	0	0.0%	7	1.2%
毎日、1合程度お酒を飲んでいる。																				
男性	1	3.3%	5	15.2%	1	7.7%	10	14.9%	4	9.3%	4	14.3%	10	18.5%	0	0.0%	1	33.3%	36	12.6%
女性	1	4.8%	2	6.5%	1	3.2%	1	1.5%	1	2.8%	1	3.4%	0	0.0%	0	0.0%	0	0.0%	7	2.3%
男女合計	2	3.9%	7	10.9%	2	4.5%	11	8.3%	5	6.3%	5	8.8%	10	9.7%	0	0.0%	1	20.0%	43	7.4%
毎日、2合程度お酒を飲んでいる。																				
男性	1	3.3%	3	9.1%	4	30.8%	9	13.4%	7	16.3%	6	21.4%	7	13.0%	0	0.0%	0	0.0%	37	12.9%
女性	0	0.0%	0	0.0%	1	3.2%	2	3.0%	1	2.8%	1	3.4%	1	2.0%	0	0.0%	0	0.0%	6	2.0%
男女合計	1	2.0%	3	4.7%	5	11.4%	11	8.3%	8	10.1%	7	12.3%	8	7.8%	0	0.0%	0	0.0%	43	7.4%
毎日、3合以上お酒を飲んでいる。																				
男性	1	3.3%	1	3.0%	2	15.4%	4	6.0%	5	11.6%	0	0.0%	0	0.0%	0	0.0%	0	0.0%	13	4.5%
女性	0	0.0%	0	0.0%	0	0.0%	0	0.0%	0	0.0%	0	0.0%	0	0.0%	0	0.0%	0	0.0%	0	0.0%
男女合計	1	2.0%	1	1.6%	2	4.5%	4	3.0%	5	6.3%	0	0.0%	0	0.0%	0	0.0%	0	0.0%	13	2.2%
毎日、お酒を飲んでいる。（飲む量未回答）																				
男性	0	0.0%	0	0.0%	0	0.0%	0	0.0%	0	0.0%	0	0.0%	0	0.0%	0	0.0%	0	0.0%	0	0.0%
女性	0	0.0%	0	0.0%	0	0.0%	0	0.0%	0	0.0%	0	0.0%	0	0.0%	0	0.0%	0	0.0%	0	0.0%
男女合計	0	0.0%	0	0.0%	0	0.0%	0	0.0%	0	0.0%	0	0.0%	0	0.0%	0	0.0%	0	0.0%	0	0.0%
週に5、6回、極少量お酒を飲んでいる。																				
男性	0	0.0%	1	3.0%	0	0.0%	1	1.5%	1	2.3%	0	0.0%	2	3.7%	1	6.7%	0	0.0%	6	2.1%
女性	0	0.0%	1	3.2%	0	0.0%	2	3.0%	0	0.0%	0	0.0%	1	2.0%	0	0.0%	0	0.0%	4	1.3%
男女合計	0	0.0%	2	3.1%	0	0.0%	3	2.3%	1	1.3%	0	0.0%	3	2.9%	1	2.1%	0	0.0%	10	1.7%
週に5、6回、1合程度お酒を飲んでいる。																				
男性	1	3.3%	0	0.0%	1	7.7%	3	4.5%	1	2.3%	1	3.6%	3	5.6%	1	6.7%	0	0.0%	11	3.8%
女性	0	0.0%	0	0.0%	2	6.5%	1	1.5%	0	0.0%	0	0.0%	0	0.0%	0	0.0%	0	0.0%	3	1.0%
男女合計	1	2.0%	0	0.0%	3	6.8%	4	3.0%	1	1.3%	1	1.8%	3	2.9%	1	2.1%	0	0.0%	14	2.4%
週に5、6回、2合程度お酒を飲んでいる。																				
男性	0	0.0%	1	3.0%	0	0.0%	0	0.0%	1	2.3%	0	0.0%	3	5.6%	1	6.7%	0	0.0%	6	2.1%
女性	0	0.0%	0	0.0%	0	0.0%	0	0.0%	0	0.0%	0	0.0%	0	0.0%	0	0.0%	0	0.0%	0	0.0%
男女合計	0	0.0%	1	1.6%	0	0.0%	0	0.0%	1	1.3%	0	0.0%	3	2.9%	1	2.1%	0	0.0%	6	1.0%
週に5、6回、3合以上お酒を飲んでいる。																				
男性	1	3.3%	1	3.0%	0	0.0%	0	0.0%	1	2.3%	0	0.0%	0	0.0%	0	0.0%	0	0.0%	3	1.0%
女性	0	0.0%	0	0.0%	0	0.0%	0	0.0%	0	0.0%	0	0.0%	0	0.0%	0	0.0%	0	0.0%	0	0.0%
男女合計	1	2.0%	1	1.6%	0	0.0%	0	0.0%	1	1.3%	0	0.0%	0	0.0%	0	0.0%	0	0.0%	3	0.5%
週に5、6回、お酒を飲んでいる。（飲む量未回答）																				
男性	0	0.0%	0	0.0%	0	0.0%	0	0.0%	0	0.0%	0	0.0%	0	0.0%	0	0.0%	0	0.0%	0	0.0%
女性	0	0.0%	0	0.0%	0	0.0%	0	0.0%	0	0.0%	0	0.0%	0	0.0%	0	0.0%	0	0.0%	0	0.0%
男女合計	0	0.0%	0	0.0%	0	0.0%	0	0.0%	0	0.0%	0	0.0%	0	0.0%	0	0.0%	0	0.0%	0	0.0%
週に3、4回、極少量お酒を飲んでいる。																				
男性	1	3.3%	1	3.0%	0	0.0%	1	1.5%	1	2.3%	0	0.0%	0	0.0%	0	0.0%	0	0.0%	4	1.4%
女性	0	0.0%	0	0.0%	0	0.0%	0	0.0%	0	0.0%	1	3.4%	0	0.0%	0	0.0%	0	0.0%	1	0.3%
男女合計	1	2.0%	1	1.6%	0	0.0%	1	0.8%	1	1.3%	1	1.8%	0	0.0%	0	0.0%	0	0.0%	5	0.9%
週に3、4回、1合程度お酒を飲んでいる。																				
男性	2	6.7%	4	12.1%	0	0.0%	3	4.5%	0	0.0%	3	10.7%	1	1.9%	2	13.3%	0	0.0%	15	5.2%
女性	0	0.0%	1	3.2%	0	0.0%	3	4.5%	0	0.0%	0	0.0%	3	6.1%	0	0.0%	0	0.0%	7	2.3%
男女合計	2	3.9%	5	7.8%	0	0.0%	6	4.5%	0	0.0%	3	5.3%	4	3.9%	2	4.2%	0	0.0%	22	3.8%
週に3、4回、2合程度お酒を飲んでいる。																				
男性	2	6.7%	0	0.0%	0	0.0%	4	6.0%	0	0.0%	1	3.6%	1	1.9%	0	0.0%	0	0.0%	8	2.8%
女性	0	0.0%	1	3.2%	2	6.5%	0	0.0%	0	0.0%	0	0.0%	0	0.0%	0	0.0%	0	0.0%	3	1.0%
男女合計	2	3.9%	1	1.6%	2	4.5%	4	3.0%	0	0.0%	1	1.8%	1	1.0%	0	0.0%	0	0.0%	11	1.9%
週に3、4回、3合以上お酒を飲んでいる。																				
男性	2	6.7%	0	0.0%	0	0.0%	0	0.0%	1	2.3%	0	0.0%	0	0.0%	0	0.0%	0	0.0%	3	1.0%
女性	0	0.0%	0	0.0%	0	0.0%	0	0.0%	0	0.0%	0	0.0%	0	0.0%	0	0.0%	0	0.0%	0	0.0%
男女合計	2	3.9%	0	0.0%	0	0.0%	0	0.0%	1	1.3%	0	0.0%	0	0.0%	0	0.0%	0	0.0%	3	0.5%
週に3、4回、お酒を飲んでいる。（飲む量未回答）																				
男性	0	0.0%	0	0.0%	0	0.0%	0	0.0%	0	0.0%	0	0.0%	0	0.0%	0	0.0%	0	0.0%	0	0.0%
女性	0	0.0%	0	0.0%	0	0.0%	0	0.0%	0	0.0%	0	0.0%	0	0.0%	0	0.0%	0	0.0%	0	0.0%
男女合計	0	0.0%	0	0.0%	0	0.0%	0	0.0%	0	0.0%	0	0.0%	0	0.0%	0	0.0%	0	0.0%	0	0.0%

	20	割合	30	割合	40	割合	50	割合	64	割合	69	割合	70	割合	80	割合	90	割合	全体数	割合		
たまたに、極少量お酒を飲んでいる。																						
男性	3	10.0%	2	6.1%	1	7.7%	2	3.0%	2	4.7%	4	14.3%	3	5.6%	2	13.3%	0	0.0%	19	6.6%		
女性	8	38.1%	3	9.7%	8	25.8%	15	22.7%	6	16.7%	4	13.8%	7	14.3%	1	3.0%	0	0.0%	52	17.4%		
男女合計	11	21.6%	5	7.8%	9	20.5%	17	12.8%	8	10.1%	8	14.0%	10	9.7%	3	6.3%	0	0.0%	71	12.2%		
たまたに、1 合程度お酒を飲んでいる。																						
男性	10	33.3%	4	12.1%	1	7.7%	5	7.5%	7	16.3%	0	0.0%	4	7.4%	2	13.3%	0	0.0%	33	11.5%		
女性	3	14.3%	9	29.0%	3	9.7%	7	10.6%	1	2.8%	1	3.4%	1	2.0%	0	0.0%	0	0.0%	25	8.4%		
男女合計	13	25.5%	13	20.3%	4	9.1%	12	9.0%	8	10.1%	1	1.8%	5	4.9%	2	4.2%	0	0.0%	58	9.9%		
たまたに、2 合程度お酒を飲んでいる。																						
男性	1	3.3%	0	0.0%	1	7.7%	1	1.5%	1	2.3%	0	0.0%	1	1.9%	0	0.0%	0	0.0%	5	1.7%		
女性	1	4.8%	2	6.5%	0	0.0%	1	1.5%	0	0.0%	0	0.0%	0	0.0%	0	0.0%	0	0.0%	4	1.3%		
男女合計	2	3.9%	2	3.1%	1	2.3%	2	1.5%	1	1.3%	0	0.0%	1	1.0%	0	0.0%	0	0.0%	9	1.5%		
たまたに、3 合以上お酒を飲んでいる。																						
男性	2	6.7%	0	0.0%	0	0.0%	4	6.0%	1	2.3%	0	0.0%	0	0.0%	0	0.0%	0	0.0%	7	2.4%		
女性	0	0.0%	0	0.0%	0	0.0%	0	0.0%	0	0.0%	0	0.0%	0	0.0%	0	0.0%	0	0.0%	0	0.0%		
男女合計	2	3.9%	0	0.0%	0	0.0%	4	3.0%	1	1.3%	0	0.0%	0	0.0%	0	0.0%	0	0.0%	7	1.2%		
たまたに、お酒を飲んでいる。(飲む量未回答)																						
男性	1	3.3%	2	6.1%	0	0.0%	0	0.0%	0	0.0%	0	0.0%	0	0.0%	0	0.0%	0	0.0%	3	1.0%		
女性	0	0.0%	0	0.0%	0	0.0%	0	0.0%	0	0.0%	0	0.0%	0	0.0%	0	0.0%	0	0.0%	0	0.0%		
男女合計	1	2.0%	2	3.1%	0	0.0%	0	0.0%	0	0.0%	0	0.0%	0	0.0%	0	0.0%	0	0.0%	3	0.5%		
*参考 以前は飲んでいたが、今は飲んでいない。																						
男性	0	0.0%	1	3.0%	0	0.0%	5	7.5%	2	4.7%	4	14.3%	8	14.8%	2	13.3%	1	33.3%	23	8.0%		
女性	1	4.8%	6	19.4%	3	9.7%	3	4.5%	0	0.0%	4	13.8%	4	8.2%	1	3.0%	0	0.0%	22	7.4%		
男女合計	1	2.0%	7	10.9%	3	6.8%	8	6.0%	2	2.5%	8	14.0%	12	11.7%	3	6.3%	1	20.0%	45	7.7%		
*参考 もともと飲まない。																						
男性	1	3.3%	5	15.2%	2	15.4%	12	17.9%	8	18.6%	3	10.7%	7	13.0%	3	20.0%	1	33.3%	42	14.7%		
女性	7	33.3%	6	19.4%	11	35.5%	29	43.9%	25	69.4%	15	51.7%	30	61.2%	29	87.9%	1	50.0%	153	51.3%		
男女合計	8	15.7%	11	17.2%	13	29.5%	41	30.8%	33	41.8%	18	31.6%	37	35.9%	32	66.7%	2	40.0%	195	33.4%		
無回答																						
男性	0	0.0%	2	6.1%	0	0.0%	2	3.0%	0	0.0%	1	3.6%	2	3.7%	0	0.0%	0	0.0%	7	2.4%		
女性	0	0.0%	0	0.0%	0	0.0%	2	3.0%	1	2.8%	1	3.4%	2	4.1%	2	6.1%	1	50.0%	9	3.0%		
男女合計	0	0.0%	2	3.1%	0	0.0%	4	3.0%	1	1.3%	2	3.5%	4	3.9%	2	4.2%	1	20.0%	16	2.7%		
全体(人)																						
男性	30		33		13		67		43		28		54		15		3		286			
女性	21		31		31		66		36		29		49		33		2		298			
男女合計	51		64		44		133		79		57		103		48		5		584			

○ 令和4年度健康ふくしま21調査（田村市、南相馬市、川俣町、広野町、楡葉町）

	10	割合	20	割合	30	割合	40	割合	50	割合	64	割合	69	割合	70～	割合	全体数	割合
1と回答																		
男性	0	0.0%	2	50.0%	3	30.0%	5	62.5%	6	33.3%	2	14.3%	7	46.7%	8	25.0%	33	32.0%
女性	1	25.0%	1	20.0%	2	28.6%	3	21.4%	8	38.1%	4	57.1%	5	55.6%	11	31.4%	35	34.3%
男女合計	1	16.7%	3	33.3%	5	29.4%	8	36.4%	14	35.9%	6	28.6%	12	50.0%	19	28.4%	68	33.2%
2と回答																		
男性	2	100.0%	2	50.0%	7	70.0%	3	37.5%	11	61.1%	11	78.6%	8	53.3%	22	68.8%	66	64.1%
女性	3	75.0%	4	80.0%	5	71.4%	11	78.6%	11	52.4%	3	42.9%	4	44.4%	20	57.1%	61	59.8%
男女合計	5	83.3%	6	66.7%	12	70.6%	14	63.6%	22	56.4%	14	66.7%	12	50.0%	42	62.7%	127	62.0%
3と回答																		
男性	0	0.0%	0	0.0%	0	0.0%	0	0.0%	1	5.6%	1	7.1%	0	0.0%	2	6.3%	4	3.9%
女性	0	0.0%	0	0.0%	0	0.0%	0	0.0%	2	9.5%	0	0.0%	0	0.0%	3	8.6%	5	4.9%
男女合計	0	0.0%	0	0.0%	0	0.0%	0	0.0%	3	7.7%	1	4.8%	0	0.0%	5	7.5%	9	4.4%
無回答																		
男性	0	0.0%	0	0.0%	0	0.0%	0	0.0%	0	0.0%	0	0.0%	0	0.0%	0	0.0%	0	0.0%
女性	0	0.0%	0	0.0%	0	0.0%	0	0.0%	0	0.0%	0	0.0%	0	0.0%	1	2.9%	1	1.0%
男女合計	0	0.0%	0	0.0%	0	0.0%	0	0.0%	0	0.0%	0	0.0%	0	0.0%	1	1.5%	1	0.5%
全体(人)																		
男性	2		4		10		8		18		14		15		32		103	
女性	4		5		7		14		21		7		9		35		102	
男女合計	6		9		17		22		39		21		24		67		205	

(60歳以上・再掲)

	64	割合	69	割合	70～	割合	80～	割合	90～	割合	全体数	割合
1と回答												
男性	2	14.3%	7	46.7%	4	16.0%	2	50.0%	2	66.7%	17	27.9%
女性	4	57.1%	5	55.6%	4	22.2%	5	38.5%	2	50.0%	20	39.2%
男女合計	6	28.6%	12	50.0%	8	18.6%	7	41.2%	4	57.1%	37	33.0%
2と回答												
男性	11	78.6%	8	53.3%	19	76.0%	2	50.0%	1	33.3%	41	67.2%
女性	3	42.9%	4	44.4%	12	66.7%	6	46.2%	2	50.0%	27	52.9%
男女合計	14	66.7%	12	50.0%	31	72.1%	8	47.1%	3	42.9%	68	60.7%
3と回答												
男性	1	7.1%	0	0.0%	2	8.0%	0	0.0%	0	0.0%	3	4.9%
女性	0	0.0%	0	0.0%	1	5.6%	2	15.4%	0	0.0%	3	5.9%
男女合計	1	4.8%	0	0.0%	3	7.0%	2	11.8%	0	0.0%	6	5.4%
無回答												
男性	0	0.0%	0	0.0%	0	0.0%	0	0.0%	0	0.0%	0	0.0%
女性	0	0.0%	0	0.0%	1	5.6%	0	0.0%	0	0.0%	1	2.0%
男女合計	0	0.0%	0	0.0%	1	2.3%	0	0.0%	0	0.0%	1	0.9%
全体(人)												
男性	14		15		25		4		3		61	
女性	7		9		18		13		4		51	
男女合計	21		24		43		17		7		112	

○ 令和3年度健康ふくしま21調査（南相馬市、川内村、浪江町、大熊町）

	10	割合	20	割合	30	割合	40	割合	50	割合	64	割合	69	割合	70～	割合	全体数	割合
1と回答																		
男性	0	0.0%	2	100.0%	0	0.0%	2	50.0%	5	62.5%	6	31.6%	6	23.1%	22	31.9%	43	32.1%
女性	1	16.7%	4	66.7%	2	40.0%	4	44.4%	9	64.3%	7	41.2%	8	44.4%	28	48.3%	63	47.4%
男女合計	1	12.5%	6	75.0%	2	22.2%	6	46.2%	14	63.6%	13	36.1%	14	31.8%	50	39.4%	106	39.7%
2と回答																		
男性	2	100.0%	0	0.0%	3	75.0%	1	25.0%	3	37.5%	11	57.9%	18	69.2%	43	62.3%	81	60.4%
女性	3	50.0%	2	33.3%	2	40.0%	4	44.4%	5	35.7%	9	52.9%	9	50.0%	28	48.3%	62	46.6%
男女合計	5	62.5%	2	25.0%	5	55.6%	5	38.5%	8	36.4%	20	55.6%	27	61.4%	71	55.9%	143	53.6%
3と回答																		
男性	0	0.0%	0	0.0%	1	25.0%	1	25.0%	0	0.0%	2	10.5%	2	7.7%	4	5.8%	10	7.5%
女性	2	33.3%	0	0.0%	0	0.0%	1	11.1%	0	0.0%	1	5.9%	1	5.6%	0	0.0%	5	3.8%
男女合計	2	25.0%	0	0.0%	1	11.1%	2	15.4%	0	0.0%	3	8.3%	3	6.8%	4	3.1%	15	5.6%
無回答																		
男性	0	0.0%	0	0.0%	0	0.0%	0	0.0%	0	0.0%	0	0.0%	0	0.0%	0	0.0%	0	0.0%
女性	0	0.0%	0	0.0%	1	20.0%	0	0.0%	0	0.0%	0	0.0%	0	0.0%	2	3.4%	3	2.3%
男女合計	0	0.0%	0	0.0%	1	11.1%	0	0.0%	0	0.0%	0	0.0%	0	0.0%	2	1.6%	3	1.1%
全体(人)																		
男性	2		2		4		4		8		19		26		69		134	
女性	6		6		5		9		14		17		18		58		133	
男女合計	8		8		9		13		22		36		44		127		267	

(60歳以上・再掲)

	64	割合	69	割合	70～	割合	80～	割合	90～	割合	全体数	割合
1と回答												
男性	6	31.6%	6	23.1%	14	31.1%	8	38.1%	0	0.0%	34	29.8%
女性	7	41.2%	8	44.4%	15	44.1%	11	57.9%	2	40.0%	43	46.2%
男女合計	13	36.1%	14	31.8%	29	36.7%	19	47.5%	2	25.0%	77	37.2%
2と回答												
男性	11	57.9%	18	69.2%	28	62.2%	12	57.1%	3	100.0%	72	63.2%
女性	9	52.9%	9	50.0%	18	52.9%	7	36.8%	3	60.0%	46	49.5%
男女合計	20	55.6%	27	61.4%	46	58.2%	19	47.5%	6	75.0%	118	57.0%
3と回答												
男性	2	10.5%	2	7.7%	3	6.7%	1	4.8%	0	0.0%	8	7.0%
女性	1	5.9%	1	5.6%	0	0.0%	0	0.0%	0	0.0%	2	2.2%
男女合計	3	8.3%	3	6.8%	3	3.8%	1	2.5%	0	0.0%	10	4.8%
無回答												
男性	0	0.0%	0	0.0%	0	0.0%	0	0.0%	0	0.0%	0	0.0%
女性	0	0.0%	0	0.0%	1	2.9%	1	5.3%	0	0.0%	2	2.2%
男女合計	0	0.0%	0	0.0%	1	1.3%	1	2.5%	0	0.0%	2	1.0%
全体(人)												
男性	19		26		45		21		3		114	
女性	17		18		34		19		5		93	
男女合計	36		44		79		40		8		207	

○ 平成30年度健康ふくしま21調査（田村市、南相馬市、川俣町、広野町、富岡町、大熊町、浪江町）

	10	割合	20	割合	30	割合	40	割合	50	割合	64	割合	69	割合	70～	割合	全体数	割合
1と回答																		
男性	1	50.0%	3	37.5%	2	22.2%	5	41.7%	8	61.5%	8	57.1%	9	29.0%	16	32.7%	52	37.7%
女性	0	0.0%	5	71.4%	2	28.6%	6	60.0%	14	51.9%	6	33.3%	10	38.5%	24	40.0%	67	43.2%
男女合計	1	50.0%	8	53.3%	4	25.0%	11	50.0%	22	55.0%	14	43.8%	19	33.3%	40	36.7%	119	40.6%
2と回答																		
男性	1	50.0%	5	62.5%	6	66.7%	5	41.7%	5	38.5%	6	42.9%	18	58.1%	27	55.1%	73	52.9%
女性	0	0.0%	2	28.6%	5	71.4%	3	30.0%	12	44.4%	10	55.6%	16	61.5%	28	46.7%	76	49.0%
男女合計	1	50.0%	7	46.7%	11	68.8%	8	36.4%	17	42.5%	16	50.0%	34	59.6%	55	50.5%	149	50.9%
3と回答																		
男性	0	0.0%	0	0.0%	1	11.1%	0	0.0%	0	0.0%	0	0.0%	2	6.5%	4	8.2%	7	5.1%
女性	0	0.0%	0	0.0%	0	0.0%	0	0.0%	0	0.0%	1	5.6%	0	0.0%	3	5.0%	4	2.6%
男女合計	0	0.0%	0	0.0%	1	6.3%	0	0.0%	0	0.0%	1	3.1%	2	3.5%	7	6.4%	11	3.8%
無回答																		
男性	0	0.0%	0	0.0%	0	0.0%	2	16.7%	0	0.0%	0	0.0%	2	6.5%	2	4.1%	6	4.3%
女性	0	0.0%	0	0.0%	0	0.0%	1	10.0%	1	3.7%	1	5.6%	0	0.0%	5	8.3%	8	5.2%
男女合計	0	0.0%	0	0.0%	0	0.0%	3	13.6%	1	2.5%	1	3.1%	2	3.5%	7	6.4%	14	4.8%
全体(人)																		
男性	2		8		9		12		13		14		31		49		138	
女性	0		7		7		10		27		18		26		60		155	
男女合計	2		15		16		22		40		32		57		109		293	

(60歳以上・再掲)

	64	割合	69	割合	70～	割合	80～	割合	90～	割合	全体数	割合
1と回答												
男性	8	57.1%	9	29.0%	8	27.6%	7	36.8%	1	100.0%	33	35.1%
女性	6	33.3%	10	38.5%	15	45.5%	9	45.0%	0	0.0%	40	38.5%
男女合計	14	43.8%	19	33.3%	23	37.1%	16	41.0%	1	12.5%	73	36.9%
2と回答												
男性	6	42.9%	18	58.1%	18	62.1%	9	47.4%	0	0.0%	51	54.3%
女性	10	55.6%	16	61.5%	16	48.5%	8	40.0%	4	57.1%	54	51.9%
男女合計	16	50.0%	34	59.6%	34	54.8%	17	43.6%	4	50.0%	105	53.0%
3と回答												
男性	0	0.0%	2	6.5%	2	6.9%	2	10.5%	0	0.0%	6	6.4%
女性	1	5.6%	0	0.0%	0	0.0%	2	10.0%	1	14.3%	4	3.8%
男女合計	1	3.1%	2	3.5%	2	3.2%	4	10.3%	1	12.5%	10	5.1%
無回答												
男性	0	0.0%	2	6.5%	1	3.4%	1	5.3%	0	0.0%	4	4.3%
女性	1	5.6%	0	0.0%	2	6.1%	1	5.0%	2	28.6%	6	5.8%
男女合計	1	3.1%	2	3.5%	3	4.8%	2	5.1%	2	25.0%	10	5.1%
全体(人)												
男性	14		31		29		19		1		94	
女性	18		26		33		20		7		104	
男女合計	32		57		62		39		8		198	

○ 平成21年度県民健康調査（田村市、南相馬市、富岡町、浪江町、葛尾村）

	10	割合	20	割合	30	割合	40	割合	50	割合	64	割合	69	割合	70～	割合	全体数	割合
1と回答																		
男性	4	23.5%	10	33.3%	13	39.4%	5	38.5%	27	40.3%	14	32.6%	6	21.4%	26	36.1%	105	34.7%
女性	1	8.3%	6	28.6%	17	54.8%	13	41.9%	28	42.4%	14	38.9%	8	27.6%	33	39.3%	120	38.7%
男女合計	5	17.2%	16	31.4%	30	46.9%	18	40.9%	55	41.4%	28	35.4%	14	24.6%	59	37.8%	225	36.7%
2と回答																		
男性	11	64.7%	16	53.3%	18	54.5%	8	61.5%	37	55.2%	24	55.8%	19	67.9%	40	55.6%	173	57.1%
女性	8	66.7%	10	47.6%	13	41.9%	16	51.6%	33	50.0%	22	61.1%	20	69.0%	39	46.4%	161	51.9%
男女合計	19	65.5%	26	51.0%	31	48.4%	24	54.5%	70	52.6%	46	58.2%	39	68.4%	79	50.6%	334	54.5%
3と回答																		
男性	2	11.8%	2	6.7%	1	3.0%	0	0.0%	2	3.0%	5	11.6%	3	10.7%	3	4.2%	18	5.9%
女性	2	16.7%	3	14.3%	1	3.2%	1	3.2%	4	6.1%	0	0.0%	1	3.4%	7	8.3%	19	6.1%
男女合計	4	13.8%	5	9.8%	2	3.1%	1	2.3%	6	4.5%	5	6.3%	4	7.0%	10	6.4%	37	6.0%
無回答																		
男性	0	0.0%	2	6.7%	1	3.0%	0	0.0%	1	1.5%	0	0.0%	0	0.0%	3	4.2%	7	2.3%
女性	1	8.3%	2	9.5%	0	0.0%	1	3.2%	1	1.5%	0	0.0%	0	0.0%	5	6.0%	10	3.2%
男女合計	1	3.4%	4	7.8%	1	1.6%	1	2.3%	2	1.5%	0	0.0%	0	0.0%	8	5.1%	17	2.8%
全体(人)																		
男性	17		30		33		13		67		43		28		72		303	
女性	12		21		31		31		66		36		29		84		310	
男女合計	29		51		64		44		133		79		57		156		613	

(60歳以上・再掲)

	64	割合	69	割合	70～	割合	80～	割合	90～	割合	全体数	割合
1と回答												
男性	14	32.6%	6	21.4%	19	35.2%	6	40.0%	1	33.3%	46	32.2%
女性	14	38.9%	8	27.6%	21	42.9%	11	33.3%	1	50.0%	55	36.9%
男女合計	28	35.4%	14	24.6%	40	38.8%	17	35.4%	2	40.0%	101	34.6%
2と回答												
男性	24	55.8%	19	67.9%	30	55.6%	8	53.3%	2	66.7%	83	58.0%
女性	22	61.1%	20	69.0%	21	42.9%	18	54.5%	0	0.0%	81	54.4%
男女合計	46	58.2%	39	68.4%	51	49.5%	26	54.2%	2	40.0%	164	56.2%
3と回答												
男性	5	11.6%	3	10.7%	2	3.7%	1	6.7%	0	0.0%	11	7.7%
女性	0	0.0%	1	3.4%	3	6.1%	3	9.1%	1	50.0%	8	5.4%
男女合計	5	6.3%	4	7.0%	5	4.9%	4	8.3%	1	20.0%	19	6.5%
無回答												
男性	0	0.0%	0	0.0%	3	5.6%	0	0.0%	0	0.0%	3	2.1%
女性	0	0.0%	0	0.0%	4	8.2%	1	3.0%	0	0.0%	5	3.4%
男女合計	0	0.0%	0	0.0%	7	6.8%	1	2.1%	0	0.0%	8	2.7%
全体(人)												
男性	43		28		54		15		3		143	
女性	36		29		49		33		2		149	
男女合計	79		57		103		48		5		292	

県民健康の日 10月10日

「健康ふくしま21計画」の策定を契機に、「すこやか、いきいき、うつくしま」の創造を目指し、県民一人ひとりが「自分の健康は自分で守る」という自覚と認識を高めるとともに、家族ぐるみ、地域ぐるみの積極的な県民参加を基調とした健康づくりを実践することを目的として「県民健康の日」を制定しました。

令和4年度

健康ふくしま21調査報告書

令和4年度健康ふくしま21調査事務局
公立大学法人 福島県立医科大学 健康増進センター

〒960-1295

福島県福島市光が丘1番地
